

Product Details and Certifications

Cross Reference RA Part Number: 1497-M-BASX-3-N A

 **Product: 1497-M-BASX-3-N**

Description: 1497 - CCT Standard Transformer, 2000VA, 240/480V 60Hz / 220/440V 50Hz Primary, 110V 50Hz / 120V 60Hz Secondary, 2 Pri - 1 Sec Fuse Blocks, No Cover/ No Sec. Fuse



Representative Photo Only (actual product may vary based on configuration sections)

TRANSFORMER DATA

Bulletin Number	1497 CCT Transformer
Continuous VA (Transformer Rating)	2000 VA
Primary Voltage	220/440V 50Hz, 240/480V 60Hz
Secondary Voltage	110V 50Hz, 120V 60Hz
Fuse Block	2 Pri - 1 Sec
Factory Installed Options	No Cover / No Sec. Fuse

CERTIFICATIONS AND APPROVALS

UL
EN
CSA
cULus
CE

For UL Certifications Directory:

<http://database.ul.com/cgi-bin/XYV/template/LISEXT/1FRAME/index.htm>

Control Circuit Transformers

Bulletin Numbers 1497, 1497A, 1497B, 1497D

Topic	Page
1497 Control Circuit Transformer	4
1497A Machine Tool Transformer	9
1497B Control Power Transformer	14
1497D General Purpose Transformer	19

Additional Resources





These documents contain additional information concerning related products from Rockwell Automation.

Resource	Description
Industrial Automation Wiring and Grounding Guidelines, publication 1770-4.1	Provides general guidelines for installing a Rockwell Automation industrial system.
Product Certifications website, http://www.ab.com	Provides declarations of conformity, certificates, and other certification details.

You can view or download publications at <http://www.rockwellautomation.com/literature/>. To order paper copies of technical documentation, contact your local Allen-Bradley distributor or Rockwell Automation sales representative.

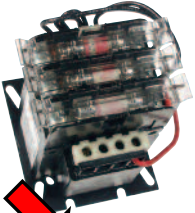

Transformers

				
Bulletin	1497	1497A	1497B	1497D
Type	Control Circuit Transformer	Machine Tool Transformer	Control Power Transformer	General Purpose Transformer
Features	<ul style="list-style-type: none"> • Single, dual, and multi-tap primary voltages • Single phase • EN 60-529 finger-safe protection • RoHS compliant • 50/60 Hz, 50 Hz, or 60 Hz • Optional Fusing 	<ul style="list-style-type: none"> • Dual/Multi-tap • RoHS compliant • Single phase • 50/60 Hz • Optional Fusing 	<ul style="list-style-type: none"> • Dual/Multi-tap • RoHS compliant • Single phase • 60 Hz only • Optional Fusing 	<ul style="list-style-type: none"> • Indoor/outdoor non-ventilated enclosure • Single phase • Exceeds requirements of the Uniform Building Code (UBC) and California Code Title 24 • Copper windings provided for all transformers rated 2 kVA and below • Aluminum windings provided for all transformers rated 2 kVA and above • NEMA Type 3R rated enclosures • 50/60 HZ or 60 Hz
Output Power	63...2000VA	50...3000VA	50...3000VA	0.05...25 kVA
Input Voltage/ Primary Voltage	208...600V 220...550 (50 Hz)	208...575V (50/60 Hz)	120...600V	208...600V
Output Voltage/ Secondary Voltage	24...120V 24...230V (50 Hz)	24...120V (50/60 Hz)	24...240V	120...240V
Insulation	63...2000VA — Class 130 °C (55...80 °C temp. rise)	50...150VA — Class 105 °C (55 °C temp. rise) 200...1500VA — Class 130 °C (80 °C temp. rise) 2000...3000VA — Class 180 °C (100 °C temp. rise)		Class 180 °C (115 °C temp. rise)
Certifications	cULus, CE	cULus	cULus	UL, CSA
Standards	CSA C22.2 No. 66.1, EN 61558, UL 5085-1, 5085-2	CSA C22.2 No. 66.1, UL 5085-1, 5085-2	CSA C22.2 No. 66.1, UL 5085-1, 5085-2	CSA C22.2 No. 47 — M90, UL 1561
Page	Page 4	Page 9	Page 14	Page 19



Cat. No. 1497-B-HXJX-3-N
Control Circuit Transformer, 3-
pole
Fuse Block with Optional
Cat. No. 1491-R150 Fuse Cover



Cat. No. 1497-C-BASX-0-N
Control Circuit Transformer,
Non-Fused

Bulletin 1497 — Global Control Circuit Transformers

Bulletin 1497 Global Control Circuit Transformers are designed to reduce supply voltages to control circuits. The complete line of transformers is available with optional factory-installed or panel-mount primary and secondary fuse block. A dual primary and secondary fuse block is pre-wired and mounted on top of the transformer up to 500VA.

- 63...2000VA
- Single, dual, and multi-tap primary voltages
- Single phase
- EN 60-529 finger-safe protection
- RoHS compliant

Standards Compliance

UL 5085-1, UL 5085-2

EN61558

CSA C22.2 No. 66.1

Certifications

cULus Listed (File No. E52057;
Guide No. XPTQ, XPTQ7)
CE

Catalog Number Explanation

Bulletin 1497 Multi-Tap Transformers

1497 - A - M1 - 3 - N
 a b c d

VA Rating	
Code	Description [VA]
A	63
B	80
C	130
D	200
E	250
F	350
G	500
H	750
J	800
K	1000
L	1600
M	2000

Primary and Secondary Voltage		
Code	Primary	Secondary
M1	240V, 208V	120V (60 Hz)
M2	240V, 208V	24V (60 Hz)
M3	240V, 208V	24V, 120V (60 Hz)
M4	415V, 400V, 380V	115X230V (50 Hz)
M5	415V, 400V, 380V	24V (50 Hz)

Fuse Block Options§	
Code	Block Options
0	0 Primary, 0 Secondary
1	0 Primary, 1 Secondary
2	2 Primary, 0 Secondary
3	2 Primary, 1 Secondary

Factory Installed Options	
Code	Description
N	No Fusing, No Cover

Bulletin 1497 Transformers

➔ 1497 - M - BASX - 3 - N
 a b c d

VA Rating	
Code	Description [VA]
A	63
B	80
C	130
D	200
E	250
F	350
G	500
H	750
J	800
K	1000
L	1600
M	2000

Primary and Secondary Voltage		
Code	Primary	Secondary
HX	208V (60 Hz)	—
AX	240V (60 Hz), 220V (50 Hz)	—
BA*	240X480V (60 Hz), 220X440V (50 Hz)	—
CX*	600V (60 Hz), 550V (50 Hz)	—
DX‡	—	120V (60 Hz)
JX	—	24V (60 Hz)
SX	—	120V (60 Hz), 110V (50Hz)
JK	—	24V (50 Hz), 26V (60 Hz)

Fuse Block Options§	
Code	Block Options
0	0 Primary, 0 Secondary
1	0 Primary, 1 Secondary
2	2 Primary, 0 Secondary
3	2 Primary, 1 Secondary

Factory Installed Options	
Code	Description
N	No Fusing, No Cover

* When the primary voltage code BA is selected and a 120V AC secondary is desired, the secondary voltage code SX should be selected.

* VA rating codes G, H, or J with primary voltage over 500V have only cULus approval.

‡ Not available for use with primary voltage code BA.

§ VA rating codes H...M are only available with no fuse block option (0).

Selecting a Control Circuit Transformer

For proper transformer selection, three characteristics of the load circuit must be determined in addition to the minimum voltage required to operate the circuit. These are total steady-state (sealed) VA, total inrush VA, and inrush load power factor.

- Total steady-state (sealed) VA is the volt-amperes that the transformer must deliver to the load circuit for an extended period of time — the amount of current required to hold the contact in the circuit.
- Total inrush VA is the volt amperes that the transformer must deliver upon initial energization of the control circuit. Energization of electromagnetic devices takes 30...50 milliseconds. During this inrush period, the electromagnetic control devices draw many times normal current — 3...10 times normal is typical.
- Inrush load power factor is difficult to determine without detailed vector analysis of all the load components. Such an analysis is generally not feasible. Therefore, a safe assumption is 40% power factor.

Selection Process

1. Determine the total inrush VA of the control circuits from the table below. Do not neglect the current requirements of indicating lights and other devices that do not have an inrush VA but are re-energized at the same time as the other components in the circuit. Their total VA should be added to the total inrush VA.
2. Refer to the table below, *Regulation Data — Inrush VA*. If the supply circuit voltage (Step 1) is reasonably stable and fluctuates not more than ± 5%, refer to the 90% secondary voltage column. If it fluctuates as much as ± 10%, refer to the 95% secondary voltage column. Go down the column selected until at the inrush VA closest to, but not less than, the inrush VA of the control circuit.
3. Read to the far left side of the chart. The transformer's continuous nominal VA rating is now selected. The secondary voltage that will be delivered under inrush conditions will be either 85%, 90%, or 95% of the rated secondary voltage, depending on the column selected from the table below, *Regulation Data — Inrush VA*. The total sealed VA of the control circuit must not exceed the nominal VA rating of the transformer selected from the table below, *Typical Magnetic Motor Starter and Contactor Data 60 Hz, 120 Volt, 3-Pole*.
4. Refer to the specification tables on the following pages to select a transformer according to the required continuous nominal VA, and primary and secondary voltage combinations.

Typical Magnetic Motor Starter and Contactor Data 60 Hz, 120 Volt, 3-Pole

Contactor	NEMA Size						
	0	1	2	3	4	5	
Bulletin 500	192	192	240	660	1225	1490	VA Inrush
	29	29	29	45	69	96	VA Sealed

Regulation Data — Inrush VA

Nominal VA Rating	Inrush VA at 40% Power Factor			Power Factor Adjustments	
	85%	90%	95%	Power Factor	Multiply By
63	347	289	216	100%	0.64
80	338	290	229	90%	0.67
130	907	745	541	80%	0.71
200	1267	1039	754	70%	0.78
250	1394	1116	781	60%	0.82
350	2870	2298	1584	50%	0.91
500	3786	3013	2065	40%	1.00
750	7360	5763	3786	30%	1.11
800	7360	5763	3786	20%	1.29
1000	8837	6785	4329	10%	1.50
1600	14921	11328	7070	—	—
2000	20500	14850	9100	—	—

Fuse Sizing Charts

Important: Select the fuse to protect the control circuit conductors in accordance with the National Electrical Code.

Primary Fuse Sizing Chart (When Only Primary Protection is Used)

Maximum Amp Rating for Current Limiting Fuses Based on Transformer Primary Voltage and the National Electrical Code

VA	208V	220V	240V	277V	347V	380V	400V	415V	440V	480V	500V	550V	600V	690V
63	0.75	0.75	0.75	0.5	0.5	0.4	0.4	0.4	0.4	0.25	0.25	0.25	0.25	0.25
80	1	1	1	0.75	0.5	0.5	0.5	0.5	0.5	0.5	0.4	0.4	0.4	0.25
130	1.5	1.5	1.5	1.25	1	1	0.75	0.75	0.75	0.75	0.75	0.5	0.5	0.5
200	2.5	2.5	2.5	2	1.5	1.5	1.5	1.25	1.25	1.25	1	1	1	0.75
250	3	3	3	2.5	2	1.5	1.5	1.5	1.5	1.5	1.5	1.25	1.25	1
350	5	4	4	3	3	2.5	2.5	2.5	2	2	2	1.5	1.5	1.5
500	4	3	3	5	4	3	3	3	3	3	3	2.5	2.5	2
750	6	5	5	4	3	5	5	5	5	4	4	4	3	3
800	6	6	5	4	3	3	3	5	5	5	4	4	4	3
1000	8	7	6	6	4	4	4	4	3	3	3	5	5	4
1600	12	12	11	9	7	7	6	6	6	5	5	4	4	3
2000	12	11	13	12	9	8	8	8	7	6	6	6	5	4

Primary Fuse Sizing Chart (When Primary and Secondary Protection is Used)

Maximum Amp Rating for Current Limiting Fuses Based on Transformer Primary Voltage and the National Electrical Code

VA	208V	220V	240V	277V	347V	380V	400V	415V	440V	480V	500V	550V	600V	690V
63	0.75	0.75	0.5	0.5	0.4	0.4	0.4	0.4	0.3	0.3	0.3	0.25	0.25	0.25
80	1.5	1.5	1.5	1	1	1	1	0.75	0.75	0.75	0.75	0.5	0.5	0.5
130	3	2.5	2.5	2	1.5	1.5	1.5	1.5	1.25	1.25	1.25	1	1	0.75
200	4	4	4	3	2.5	2.5	2.5	2	2	2	2	1.5	1.5	1
250	6	5	5	4	3	3	3	3	2.5	2.5	2.5	2	2	1.5
350	8	7	7	6	5	4	4	4	3	3	3	3	2.5	2.5
500	6	5	5	9	7	6	6	6	5	5	5	4	4	3
750	9	8	7	6	5	9	9	9	8	7	7	6	6	5
800	9	9	8	7	5	5	5	8	8	8	8	7	6	5
1000	12	10	10	9	7	6	6	6	5	5	5	8	8	7
1600	15	15	15	12	11	10	10	9	9	8	8	7	6	5
2000	20	20	20	18	14	12	12	12	10	10	10	9	8	7

Secondary Fuse Sizing Chart

Maximum Amp Rating for Current Limiting Fuses Based on the National Electrical Code

VA	24V	110V	115V	120V	230V
63	4	0.75	0.75	0.75	0.4
80	5	1	1	1	0.5
130	9	1.8	1.8	1.8	0.9
200	13	2.5	2.5	2.5	1.25
250	15	3.2	3.2	3.2	1.5
350	20	4.5	4.5	4.5	2.5
500	30	6.25	6.25	6.25	3
750	45	9	9	9	4.5
800	45	9	9	9	4.5
1000	60	12	12	12	6
1600	100	20	20	20	10
2000	—	25	25	25	12

Dimensions are shown in inches (millimeters). Dimensions are not intended to be used for manufacturing purposes.

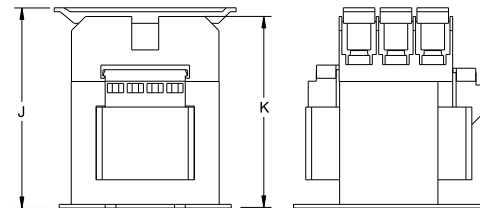
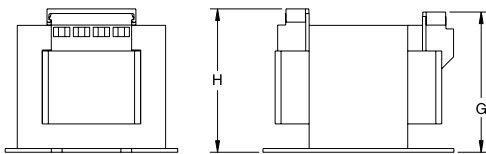
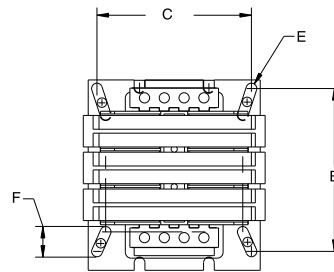
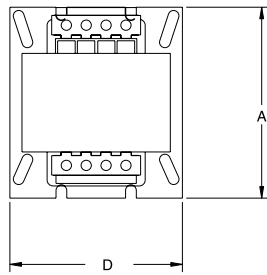

Transformer without Fusing

Transformer with Fuse Holder and Covers

VA	A	B	C	D	E	F	G	H	J	K	Approximate Shipping Wt. — lb (kg)	
											Without Top-Mounted Fuse Block	2-Pole Primary and 1-Pole Secondary Top-Mounted Fuse Block
63	3-7/8 (98.00)	3-1/4 (82.55)	3-1/8 (79.38)	3-1/2 (88.90)	7/32 (5.54)	22/32 (18.29)	2-27/32 (72.39)	2-3/8 (73.91)	4-5/64 (103.51)	3-57/64 (99.01)	4-1/2 (2.04)	4-4/5 (2.18)
80	3-7/8 (98.00)	3-1/4 (82.55)	3-1/8 (79.38)	3-1/2 (88.90)	7/32 (5.54)	22/32 (18.29)	2-27/32 (72.39)	2-3/8 (73.91)	4-5/64 (103.51)	3-57/64 (99.01)	4-1/2 (2.04)	4-4/5 (2.18)
130	3-7/8 (98.00)	3-1/4 (82.55)	3-1/8 (79.38)	3-1/2 (88.90)	7/32 (5.54)	22/32 (18.29)	3-3/8 (85.60)	3-13/32 (86.61)	4-45/64 (119.5)	4-35/64 (115.44)	6-7/10 (3.04)	7-3/20 (3.24)

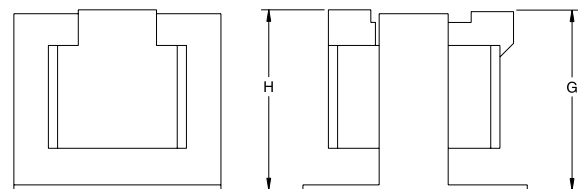
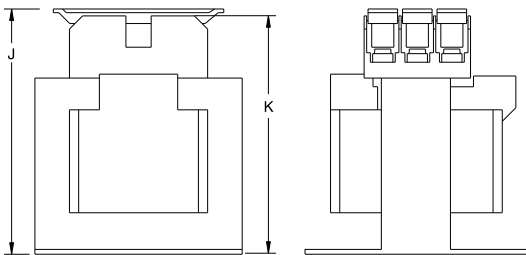
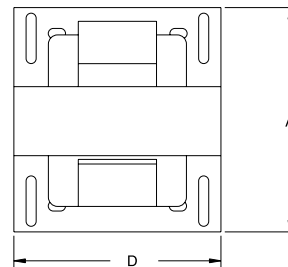
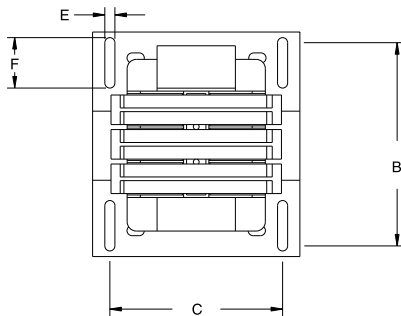

Transformer with Fuse Holder and Covers

Transformer without Fusing

VA	A	B	C	D	E	F	G	H	J	K	Approximate Shipping Wt. — lb (kg)	
											Without Top-Mounted Fuse Block	2-Pole Primary and 1-Pole Secondary Top-Mounted Fuse Block
200	4-7/8 (123.95)	4-7/16 (112.78)	3-3/4 (95.25)	4-1/2 (114.30)	7/32 (5.59)	1-1/8 (28.70)	3-3/8 (85.60)	3-29/32 (86.61)	5-21/64 (135.26)	5-11/64 (131.44)	8-2/5 (3.81)	8-7/10 (3.95)
250	4-7/8 (123.95)	4-7/16 (108.20)	3-3/4 (95.25)	4-1/2 (114.30)	7/32 (5.59)	1-1/8 (28.70)	3-7/8 (98.30)	3-29/32 (98.30)	5-21/64 (135.26)	5-11/64 (131.44)	10-2/5 (4.72)	10-4/5 (4.90)
350	4-7/8 (123.95)	4-7/16 (108.20)	3-3/4 (95.25)	4-1/2 (114.30)	7/32 (5.59)	1-1/8 (28.70)	3-7/8 (98.30)	3-29/32 (98.30)	5-21/64 (135.26)	5-11/64 (131.44)	13-2/5 (6.08)	13-4/5 (6.26)

Dimensions are shown in inches (millimeters). Dimensions are not intended to be used for manufacturing purposes.

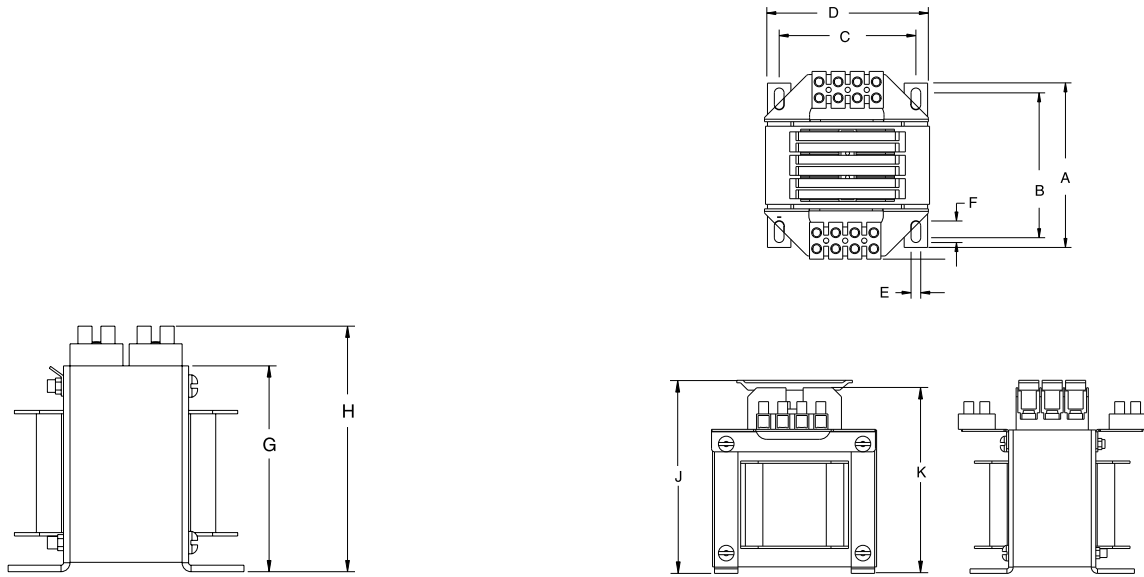

Transformer without Fusing

Transformer with Fuse Holder and Covers

VA	A	B	C	D	E	F	G	H	J	K	Approximate Shipping Wt. — lb (kg)	
											Without Top-Mounted Fuse Block	2-Pole Primary and 1-Pole Secondary Top-Mounted Fuse Block
500	5-1/4 (133.35)	4-33/64 (114.81)	4-3/8 (111.25)	5-1/4 (133.35)	5/16 (7.87)	45/64 (18.03)	4-17/32 (114.81)	5-1/2 (139.70)	6-3/16 (156.97)	5-15/16 (150.62)	17-3/5 (7.98)	17-19/20 (8.14)

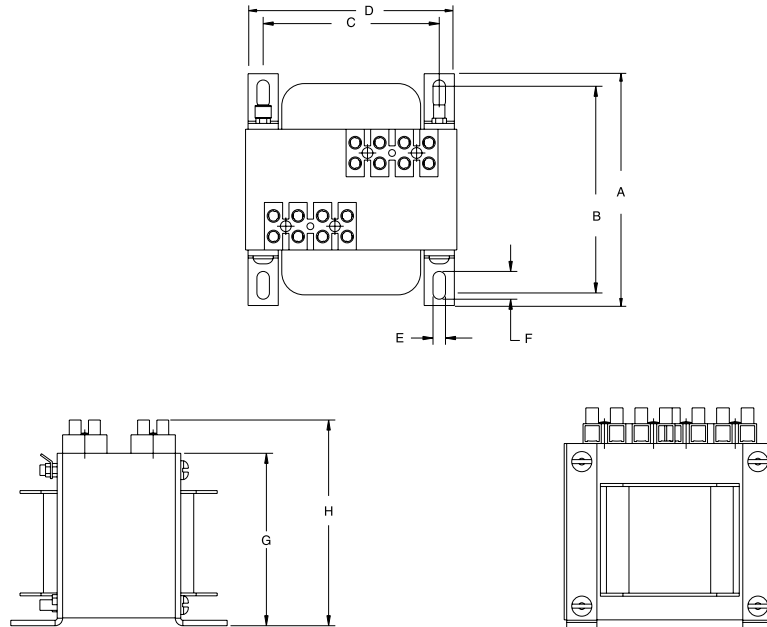

Transformer without Fusing

VA	A	B	C	D	E	F	G	H	Approximate Shipping Wt. — lb (kg)
									Without Top-Mounted Fuse Block
750	5-3/4 (146.05)	5 (127.51)	4-3/8 (111.25)	5-1/4 (133.35)	5/16 (7.87)	45/64 (18.03)	4-9/16 (114.81)	5-19/32 (137.41)	21-1/2 (9.75)
800	5-3/4 (146.05)	5 (127.51)	4-3/8 (111.25)	5-1/4 (133.35)	5/16 (7.87)	45/64 (18.03)	4-9/16 (114.81)	5-19/32 (137.41)	21-1/2 (9.75)
1000	6-3/8 (161.92)	5-3/8 (136.53)	5-5/16 (134.94)	6-3/8 (161.92)	5/16 (7.87)	45/64 (18.03)	5-33/64 (140.21)	6-1/2 (162.56)	37-1/5 (16.87)
1600	8-1/2 (215.90)	7-1/4 (184.15)	5-3/4 (143.76)	6-3/4 (171.45)	7/16 (10.92)	45/64 (18.03)	5-3/4 (146.05)	7-1/16 (168.66)	50-4/5 (23.04)
2000	9-1/2 (241.30)	8-1/4 (209.55)	5-3/4 (143.76)	6-3/4 (171.45)	7/16 (10.92)	45/64 (18.03)	5-11/64 (149.86)	7-1/16 (172.47)	61 (27.67)

