



1756 ControlLogix Power Supplies Specifications

Standard Chassis Catalog Numbers 1756-A4, 1756-A10, 1756-A13, 1756-A17

ControlLogix-XT Chassis Catalog Numbers 1756-A4LXT, 1756-A5XT, 1756-A7XLT, 1756-A7XT

Standard Power Supplies Catalog Numbers 1756-PA72, 1756-PA75, 1756-PB72, 1756-PB75, 1756-PC75, 1756-PH75

ControlLogix-XT Power Supplies Catalog Numbers 1756-PAXT, 1756-PBXT

Redundant Power Supplies Catalog Numbers 1756-PA75R, 1756-PB75R

Redundant Power Supplies Chassis Adapter Module Catalog Number 1756-PSCA2

ControlLogix-XT Redundant Power Supplies Catalog Numbers 1756-PAXTR, 1756-PBXTR

ControlLogix-XT Redundant Power Supplies Chassis Adapter Module Catalog Number 1756-PSCA2XT

Topic	Page
Standard AC power supplies	2
Standard DC Power Supplies	5
1756 ControlLogix-XT Power Supplies	8
Redundant Power Supplies	11

ControlLogix® power supplies are used with the 1756 chassis to provide 1.2V, 3.3V, 5V, and 24V DC power directly to the chassis backplane. Standard, ControlLogix-XT™, and redundant power supplies are available.



Summary of Changes

This manual contains new and updated information. Changes throughout this revision are marked by change bars, as shown to the left of this paragraph.

Topic	Page
Added Technical Specifications, Environmental Specifications, and Certifications tables for of Tables for ControlLogix-XT Redundant Power Supplies	15, 17
Updated the tables to include the ControlLogix-XT Redundant Power Supply Chassis Adapter	17

The following components were added to this technical data:

- ControlLogix-XT Redundant Power Supply (catalog number 1756-PAXTR)
- ControlLogix-XT Redundant Power Supply (catalog number 1756-PBXTR)
- ControlLogix-XT Redundant Power Supply Chassis Adapter Module (catalog number 1756-PSCA2XT)
- Standard AC power supplies

Standard AC Power Supplies

1756-PA72 and 1756-PB75 Mounting Dimensions

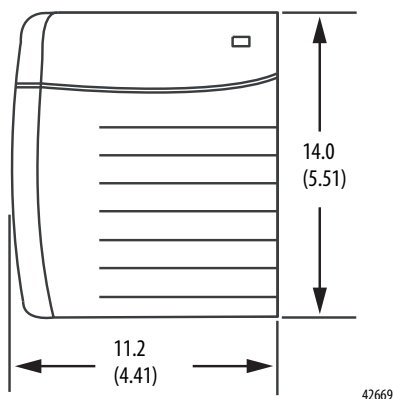

Dimensions are in cm (in.).

Table 1 - Technical Specifications - Standard AC Power Supplies

Attribute	1756-PA72/C	1756-PA75/B
Input voltage range ⁽¹⁾	85...265V AC	
Input voltage, nom	120V/240V AC	
Input frequency range	47...63 Hz	
Input power, max	100VA/100 W	
Output power, max	75 W @ 0...60 °C (32...140 °F) ⁽³⁾	
Power consumption	25 W @ 0...60 °C (32...140 °F)	
Power dissipation	85.3 BTU/hr	

Table 1 - Technical Specifications - Standard AC Power Supplies

Attribute	1756-PA72/C	1756-PA75/B
Hold-up time ⁽²⁾	5 cycles @ 85V AC, 50/60 Hz 6 cycles @ 120V AC, 50/60 Hz 6 cycles @ 200V AC, 50/60 Hz 6 cycles @ 240V AC, 50/60 Hz	
Inrush current, max	20 A	
Current capacity at 1.2V DC	1.5 A	
Current capacity at 3.3V DC	4 A	
Current capacity at 5.1V DC	10 A	13 A
Current capacity at 24V DC	2.8 A	
Overcurrent protection, max	User-supplied 15 A ⁽⁴⁾	
Fusing	Non-replaceable fuse is soldered in place ⁽⁵⁾	
Transformer load, max	100VA	
Isolation voltage	250V (continuous), reinforced insulation type Type tested @ 3500V DC for 60 s, power input-to-backplane approx	
Weight, approx	0.95 kg (2.10 lb)	
Dimensions	14.0 x 11.2 x 14.5 cm (5.51 x 4.41 x 5.71 in.)	
Module location	Left side of 1756 chassis	
Chassis	1756-A4, 1756-A7, 1756-A10, 1756-A13, 1756-A17	
Chassis compatibility	Series A Series B	Series B
Wire size	2.5 mm ² (14 AWG) solid or stranded copper wire rated at 90 °C (194 °F), or greater, 1.2 mm (3/64 in.) insulation max	
Wire category	1 - on power ports ⁽⁶⁾	
Conductor screw torque	0.8 N•m (7 lb•in)	
North American temperature code	T4	
Enclosure type rating	None (open-style)	

(1) UL certification for 120/240V AC, 50/60 Hz nominal. Rockwell Automation specified 85...265V AC, 47...63 Hz.

(2) The hold-up time is the time between input voltage removal and DC power failure.

(3) The combination of all output power (5.1V backplane, 24V backplane, 3.3V backplane, and 1.2V backplane) cannot exceed 75 W.

(4) Use time-delay type overcurrent protection in all ungrounded conductors.

(5) This fuse is intended to guard against fire hazard due to short circuit conditions.

(6) Use this conductor category information for planning conductor routing as described in the system level installation manual. See the Industrial Automation Wiring and Grounding Guidelines, publication [1770-4.1](#).

Table 2 - Environmental Specifications - Standard AC Power Supplies

Attribute	1756-PA72/C, 1756-PA75/B
Temperature, operating IEC 60068-2-1 (Test Ad, Operating Cold), IEC 60068-2-2 (Test Bd, Operating Dry Heat), IEC 60068-2-14 (Test Nb, Operating Thermal Shock)	0...60 °C (32...140 °F)
Temperature, surrounding air, max	60 °C (140 °F)
Temperature, non-operating IEC 60068-2-1 (Test Ab, Unpackaged Nonoperating Cold), IEC 60068-2-2 (Test Bb, Unpackaged Nonoperating Dry Heat), IEC 60068-2-14 (Test Na, Unpackaged Nonoperating Thermal Shock)	-40...85 °C (-40...185 °F)
Relative humidity IEC 60068-2-30 (Test Db, Unpackaged Damp Heat)	5...95% noncondensing
Vibration IEC 60068-2-6 (Test Fc, Operating)	2 g @ 10...500 Hz
Shock, operating IEC 60068-2-27 (Test Ea, Unpackaged Shock)	30 g

Table 2 - Environmental Specifications - Standard AC Power Supplies

Attribute	1756-PA72/C, 1756-PA75/B
Shock, nonoperating IEC 60068-2-27 (Test Ea, Unpackaged Shock)	50 g
Emissions CISPR 11 (IEC 61000-6-4)	Class A
ESD immunity IEC 61000-4-2	6 kV contact discharges 8 kV air discharges
Radiated RF immunity IEC 61000-4-3	10V/m with 1 kHz sine-wave 80% AM from 80...2000 MHz 10V/m with 200 Hz 50% Pulse 100% AM @ 900 MHz 10V/m with 200 Hz 50% Pulse 100% AM @ 1890 MHz 3V/m with 1kHz sine-wave 80% AM from 2000...2700 MHz
EFT/B immunity IEC 61000-4-4	±4 kV at 5 kHz on power ports
Surge transient immunity IEC 61000-4-5	±1 kV line-line (DM) and ±2 kV line-earth (CM) on power ports
Conducted RF immunity IEC 61000-4-6	10V rms with 1 kHz sine-wave 80% AM from 150 kHz...80 MHz
Oscillatory surge withstand IEEE C37.90.1	3 kV
Voltage variation IEC 61000-4-11	30% dips for 1 period at 0° and 180° on AC supply ports 60% dips for 5 and 50 periods on AC supply ports ±10% fluctuations for 15 min on AC supply ports >95% interruptions for 250 periods on AC supply ports

Table 3 - Certifications - Standard AC Power Supplies

Certification ⁽¹⁾	1756-PA72/C, 1756-PA75/B
UL	UL Listed Industrial Control Equipment. See UL File E65584.
CSA	CSA Certified Process Control Equipment. See CSA File LR54689C. CSA Certified Process Control Equipment for Class I, Division 2 Group A,B,C,D Hazardous Locations. See CSA File LR69960C.
FM	FM Approved Equipment for use in Class I Division 2 Group A,B,C,D Hazardous Locations
CE	European Union 2004/108/EC EMC Directive, compliant with: <ul style="list-style-type: none"> EN 61326-1; Meas./Control/Lab., Industrial Requirements EN 61000-6-2; Industrial Immunity EN 61000-6-4; Industrial Emissions EN 61131-2; Programmable Controllers (Clause 8, Zone A & B) European Union 2006/95/EC LVD, compliant with: <ul style="list-style-type: none"> EN 61131-2; Programmable Controllers (Clause 11)
C-Tick	Australian Radiocommunications Act, compliant with: <ul style="list-style-type: none"> AS/NZS CISPR 11; Industrial Emissions
KC	Korean Registration of Broadcasting and Communications Equipment, compliant with: <ul style="list-style-type: none"> Article 58-2 of Radio Waves Act, Clause 3

(1) When marked. See the Product Certification link at <http://www.ab.com> for Declarations of Conformity, Certificates, and other certification details.

Standard DC Power Supplies

1756-PB72, 1756-PB75, 1756-PC75, and 1756-PH75 Mounting Dimensions

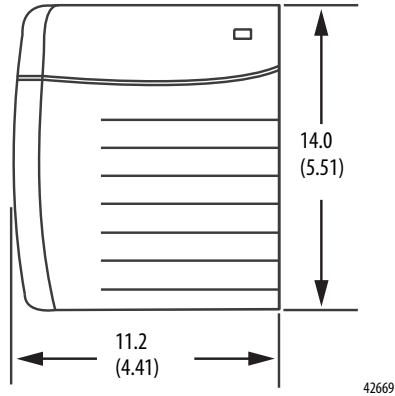

Dimensions are in cm (in.).

Table 4 - Technical Specifications - Standard DC Power Supplies

Attribute	1756-PB72/C	1756-PB75/B	1756-PC75/B	1756-PH75/B
Input voltage range	18...32V DC ⁽²⁾		30...60V DC ⁽⁷⁾	90...143V DC ⁽⁸⁾
Input voltage, nom	24V DC		48V DC	125V DC
Input power, max	95 W			
Output power, max	75 W @ 0...60 °C (32...140 °F) ⁽³⁾			
Power consumption	20 W @ 0...60 °C (32...140 °F)			
Power dissipation	68.2 BTU/hr			
Hold-up time ⁽¹⁾	35 ms @ 18V DC 40 ms @ 24V DC 40 ms @ 32V DC		50 ms @ 30...60V DC nom	50 ms @ 90...143V DC nom
Inrush current, max	30 A		20 A	
Current capacity at 1.2V	1.5 A			
Current capacity at 3.3V	4 A			
Current capacity at 5.1V	10 A	13 A		
Current capacity at 24V	2.8 A			
Overcurrent protection, max	User-supplied 15 A ⁽⁴⁾			
Fusing	Non-replaceable fuse is soldered in place ⁽⁵⁾			
Isolation voltage	250V (continuous), reinforced insulation type, power input-to-backplane Type tested @ 3500V DC for 60 s			
Weight, approx	0.95 kg (2.10 lb)			
Dimensions	14.0 x 11.2 x 14.5 cm (5.51 x 4.41 x 5.71 in.)			
Module location	Left side of 1756 chassis			
Chassis	1756-A4, 1756-A7, 1756-A10, 1756-A13, 1756-A17			
Chassis compatibility	Series A Series B	Series B		
Wire size	2.5 mm ² (14 AWG) solid or stranded copper wire rated at 90 °C (194 °F), or greater, 1.2 mm (3/64 in.) insulation max			
Wire category	1 - on power ports ⁽⁶⁾			

Table 4 - Technical Specifications - Standard DC Power Supplies

Attribute	1756-PB72/C	1756-PB75/B	1756-PC75/B	1756-PH75/B
Conductor screw torque	0.8 N·m (7 lb·in)			
North American temperature code	T4			
IEC temperature code	T4		N/A	
Enclosure type rating	None (open-style)			

- (1) The hold-up time is the time between input voltage removal and DC power failure.
- (2) UL certification for 24V DC nominal. Rockwell Automation specified 18...32V DC.
- (3) The combination of all output power (5.1V backplane, 24V backplane, 3.3V backplane, and 1.2V backplane) cannot exceed 75 W.
- (4) Use time-delay type overcurrent protection in all ungrounded conductors.
- (5) This fuse is intended to guard against fire hazard due to short circuit conditions.
- (6) Use this conductor category information for planning conductor routing as described in the system level installation manual. See the Industrial Automation Wiring and Grounding Guidelines, publication [1770-4.1](#).
- (7) UL Certification for 48V DC nominal. Rockwell Automation specified 30...60V DC.
- (8) UL certification for 125V DC nominal. Rockwell Automation specified 90...143V DC.

Table 5 - Environmental Specifications - Standard DC Power Supplies

Attribute	1756-PB72/C, 1756-PB75/B	1756-PC75/B, 1756-PH75/B
Temperature, operating IEC 60068-2-1 (Test Ad, Operating Cold), IEC 60068-2-2 (Test Bd, Operating Dry Heat), IEC 60068-2-14 (Test Nb, Operating Thermal Shock)	0...60 °C (32...140 °F)	
Temperature, surrounding air, max	60 °C (140 °F)	
Temperature, nonoperating IEC 60068-2-1 (Test Ab, Unpackaged Nonoperating Cold), IEC 60068-2-2 (Test Bb, Unpackaged Nonoperating Dry Heat), IEC 60068-2-14 (Test Na, Unpackaged Nonoperating Thermal Shock)	-40...85 °C (-40...185 °F)	
Relative humidity IEC 60068-2-30 (Test Db, Unpackaged Damp Heat)	5...95% noncondensing	
Vibration IEC 60068-2-6 (Test Fc, Operating)	2 g @ 10...500 Hz	
Shock, operating IEC 60068-2-27 (Test Ea, Unpackaged Shock)	30 g	
Shock, nonoperating IEC 60068-2-27 (Test Ea, Unpackaged Shock)	50 g	
Emissions CISPR 11 (IEC 61000-6-4)	Class A	
ESD immunity IEC 61000-4-2	6 kV contact discharges 8 kV air discharges	
Radiated RF immunity IEC 61000-4-3	10V/m with 1 kHz sine-wave 80% AM from 80...2000 MHz 10V/m with 200 Hz 50% Pulse 100% AM @ 900 MHz 10V/m with 200 Hz 50% Pulse 100% AM @ 1890 MHz 3V/m with 1 kHz sine-wave 80% AM from 2000...2700 MHz	
EFT/B immunity IEC 61000-4-4	±4 kV at 5 kHz on power ports	
Surge transient immunity IEC 61000-4-5	±1 kV line-line (DM) and ±2 kV line-earth (CM) on power ports	
Conducted RF immunity IEC 61000-4-6	10V rms with 1 kHz sine-wave 80% AM from 150 kHz...80 MHz	
Oscillatory surge withstand IEEE C37.90.1	N/A	3 kV
Voltage variation IEC 61000-4-29	60% dips for 100 ms on DC supply ports 100% dips for 50 ms on DC supply ports ±20% fluctuations for 15 min on DC supply ports 5 s interruptions on DC supply ports 10 ms interruption on DC supply ports	

Table 6 - Certifications - Standard DC Power Supplies

Certification ⁽¹⁾	1756-PB72/C, 1756-PB75/B	1756-PC75/B, 1756-PH75/B
UL	N/A	UL Listed Industrial Control Equipment. See UL File E65584.
c-UL-us	UL Listed Industrial Control Equipment, certified for US and Canada. See UL File E65584. UL Listed for Class I, Division 2 Group A,B,C,D Hazardous Locations, certified for US and Canada. See UL File E194810.	N/A
CSA	CSA Certified Process Control Equipment. See CSA File LR54689C. CSA Certified Process Control Equipment for Class I, Division 2 Group A,B,C,D Hazardous Locations. See CSA File LR69960C.	
FM	FM Approved Equipment for use in Class I Division 2 Group A,B,C,D Hazardous Locations	N/A
CE	European Union 2004/108/EC EMC Directive, compliant with: <ul style="list-style-type: none"> • EN 61326-1; Meas./Control/Lab., Industrial Requirements • EN 61000-6-2; Industrial Immunity • EN 61000-6-4; Industrial Emissions • EN 61131-2; Programmable Controllers (Clause 8, Zone A & B) European Union 2006/95/EC LVD, compliant with: <ul style="list-style-type: none"> • EN 61131-2; Programmable Controllers (Clause 11) 	
C-Tick	Australian Radiocommunications Act, compliant with: <ul style="list-style-type: none"> • AS/NZS CISPR 11; Industrial Emissions 	
Ex	European Union 94/9/EC ATEX Directive, compliant with: <ul style="list-style-type: none"> • EN 60079-15; Potentially Explosive Atmospheres, Protection "n" • EN 60079-0; General Requirements • II 3 G Ex nA IIC T4 Gc X 	N/A
KC	Korean Registration of Broadcasting and Communications Equipment, compliant with: <ul style="list-style-type: none"> • Article 58-2 of Radio Waves Act, Clause 3 	

(1) When marked. See the Product Certification link at <http://www.ab.com> for Declarations of Conformity, Certificates, and other certification details.

1756 ControlLogix-XT Power Supplies

The ControlLogix-XT products include control and communication system components that, when used with FLEX I/O-XT™ products, provide a complete control system solution that you can use in environments where temperatures range from -20...70 °C (-4...158 °F).

When used independently, the ControlLogix-XT system can withstand environments where the temperature ranges from -25...70 °C (-13...158 °F).

1756-PAXT and 1756-PBXT Mounting Dimensions

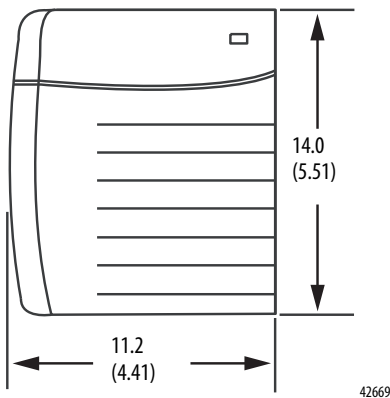

Dimensions are in cm (in.).

Table 7 - Technical Specifications - ControlLogix-XT Power Supplies

Attribute	1756-PAXT	1756-PBXT
Input voltage range	85...265V AC ⁽²⁾	18...32V DC
Input voltage, nom	120/240V AC	24V DC
Input frequency range	47...63 Hz	N/A
Input power, max	82VA 64 W	54 W
Output power, max	42 W @ -25...70 °C (-13...158 °F)	
Power consumption	22 W	12 W
Power dissipation	75.1 BTU/hr	40.9 BTU/hr
Hold-up time ⁽¹⁾	6 cycles @ 85V AV, 50/60 Hz 6 cycles @ 120V AV, 50/60 Hz 6 cycles @ 200V AV, 50/60 Hz 6 cycles @ 240V AV, 50/60 Hz	35 ms @ 18V DC 40 ms @ 24V DC 40 ms @ 32V DC
Inrush current, max	20 A	30 A
Current capacity at 1.2V	1.5 A	
Current capacity at 3.3V	4 A	
Current capacity at 5.1V	8 A	
Current capacity at 24V	1.75 A	
Overcurrent protection, max	User-supplied 15 A ⁽³⁾	
Fusing	Non-replaceable fuse is soldered in place ⁽⁴⁾	
Isolation voltage	250V (continuous), reinforced insulation type, power input-to-backplane Type tested @ 3260V DC for 60 s	

Table 7 - Technical Specifications - ControlLogix-XT Power Supplies

Attribute	1756-PAXT	1756-PBXT
Weight, approx	0.95 kg (2.10 lb)	
Dimensions	14.0 x 11.2 x 14.5 cm (5.51 x 4.41 x 5.71 in.)	
Module location	Left side of 1756 chassis	
Chassis	1756-A4LXT, 1756-A5XT, 1756-A7LXT, 1756-A7XT	
Wire size	2.5 mm ² (14 AWG) solid or stranded copper wire rated at 90 °C (194 °F), or greater, 1.2 mm (3/64 in.) insulation max	
Wire category	1 - on power ports ⁽⁵⁾	
Conductor screw torque	0.8 N·m (7 lb·in)	
North American temperature code	T4	T4A
IEC temperature code	T4	
Enclosure type rating	None (open-style)	

- (1) The hold-up time is the time between input voltage removal and DC power failure.
- (2) UL certification for 120/240V AC, 50/60 Hz nominal. Rockwell Automation specified 85...265V AC, 47...63 Hz.
- (3) Use time-delay type overcurrent protection in all ungrounded conductors.
- (4) This fuse is intended to guard against fire hazard due to short circuit conditions.
- (5) Use this conductor category information for planning conductor routing as described in the system level installation manual. See the Industrial Automation Wiring and Grounding Guidelines, publication [1770-4.1](#).

Table 8 - Environmental Specifications - ControlLogix-XT Power Supplies

Attribute	1756-PAXT	1756-PBXT
Temperature, operating IEC 60068-2-1 (Test Ad, Operating Cold), IEC 60068-2-2 (Test Bd, Operating Dry Heat), IEC 60068-2-14 (Test Nb, Operating Thermal Shock)	-25...70 °C (-13...158 °F)	
Temperature, surrounding air, max	70 °C (158 °F)	
Temperature, nonoperating IEC 60068-2-1 (Test Ab, Unpackaged Nonoperating Cold), IEC 60068-2-2 (Test Bb, Unpackaged Nonoperating Dry Heat), IEC 60068-2-14 (Test Na, Unpackaged Nonoperating Thermal Shock)	-40...85 °C (-40...185 °F)	
Relative humidity IEC 60068-2-30 (Test Db, Unpackaged Damp Heat)	5...95% noncondensing	
Vibration IEC 60068-2-6 (Test Fc, Operating)	2 g @ 10...500 Hz	
Shock, operating IEC 60068-2-27 (Test Ea, Unpackaged Shock)	30 g	
Shock, nonoperating IEC 60068-2-27 (Test Ea, Unpackaged Shock)	50 g	
Emissions CISPR 11 (IEC 61000-6-4)	Class A	
ESD immunity IEC 61000-4-2	6 kV contact discharges 8 kV air discharges	
Radiated RF immunity IEC 61000-4-3	10V/m with 1 kHz sine-wave 80% AM from 80...2000 MHz 10V/m with 200 Hz 50% Pulse 100% AM at 900 MHz 10V/m with 200 Hz 50% Pulse 100% AM at 1890 MHz 3V/m with 1 kHz sine-wave 80% AM from 2000...2700 MHz	
EFT/B immunity IEC 61000-4-4	±4 kV at 5 kHz on power ports	
Surge transient immunity IEC 61000-4-5	±1 kV line-line (DM) and ±2 kV line-earth (CM) on power ports	
Conducted RF immunity IEC 61000-4-6	10V rms with 1 kHz sine-wave 80% AM from 150 kHz...80 MHz	

Table 8 - Environmental Specifications - ControlLogix-XTPower Supplies

Attribute	1756-PAXT	1756-PBXT
Oscillatory surge withstand IEEE C37.90.1	3 kV	N/A
Voltage variation IEC 61000-4-11	30% dips for 1 period at 0° and 180° on AC supply ports 60% dips for 5 and 50 periods on AC supply ports ±10% fluctuations for 15 min on AC supply ports >95% interruptions for 250 periods on AC supply ports	N/A
Voltage variation IEC 61000-4-29	N/A	60% dips for 100 ms on DC supply ports 100% dips for 50 ms on DC supply ports ±20% fluctuations for 15 min on DC supply ports 5 s interruptions on DC supply ports 10 ms interruption on DC supply ports

Table 9 - Certifications - ControlLogix-XPowerT Supplies

Certification ⁽¹⁾	1756-PAXT, 1756-PBXT
c-UL-us	UL Listed Industrial Control Equipment, certified for US and Canada. See UL File E65584. UL Listed for Class I, Division 2 Group A,B,C,D Hazardous Locations, certified for US and Canada. See UL File E194810.
CE	European Union 2004/108/EC EMC Directive, compliant with: <ul style="list-style-type: none"> EN 61326-1; Meas./Control/Lab., Industrial Requirements EN 61000-6-2; Industrial Immunity EN 61000-6-4; Industrial Emissions EN 61131-2; Programmable Controllers (Clause 8, Zone A & B) European Union 2006/95/EC LVD, compliant with: <ul style="list-style-type: none"> EN 61131-2; Programmable Controllers (Clause 11)
C-Tick	Australian Radiocommunications Act, compliant with: <ul style="list-style-type: none"> AS/NZS CISPR 11; Industrial Emissions
Ex	European Union 94/9/EC ATEX Directive, compliant with: <ul style="list-style-type: none"> EN 60079-15; Potentially Explosive Atmospheres, Protection "n" EN 60079-0; General Requirements II 3 G Ex nA IIC T4 Gc X
KC	Korean Registration of Broadcasting and Communications Equipment, compliant with: <ul style="list-style-type: none"> Article 58-2 of Radio Waves Act, Clause 3

(1) When marked. See the Product Certification link at <http://www.ab.com> for Declarations of Conformity, Certificates, and other certification details.

Redundant Power Supplies

To build a redundant power supply system, you need the following.

Cat. No.	Description	Amount
1756-PA75R/A, 1756-PAXTR, 1756-PB75R/A, or 1756-PBXTR	Redundant power supply	2
1756-CPR2 ⁽¹⁾	Redundant power supply cable (Length = 0.9 1m [3 ft])	2
1756-PSCA2 or 1756-PSCA2XT	Redundant power supply chassis adapter module ⁽²⁾	1
User-supplied	Annunciator wiring ⁽³⁾ (Max. length = 10 m [32.8 ft])	2

(1) Cable bend radius is 12.7 cm (5.0 in.).

(2) The 1756-PSCA2 or 1756-PSCA-2XT chassis adapter module is a passive device that funnels power from the redundant power supplies to the single power connector on the ControlLogix series B chassis backplane.

(3) Optional user-provided annunciator wiring can be connected to the solid-state relay for status and troubleshooting purposes.

System Configuration Recommendations

We recommend that you use one of these methods to configure your redundant power supply system.

Recommended Configurations for a System That Uses One Chassis

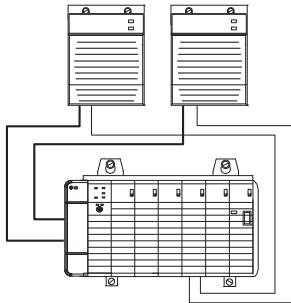

42655

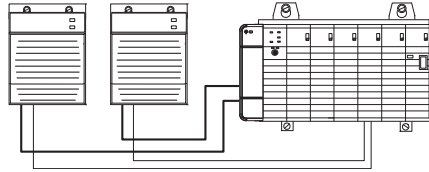

42657

Recommended Configurations for a System That Uses Two Chassis

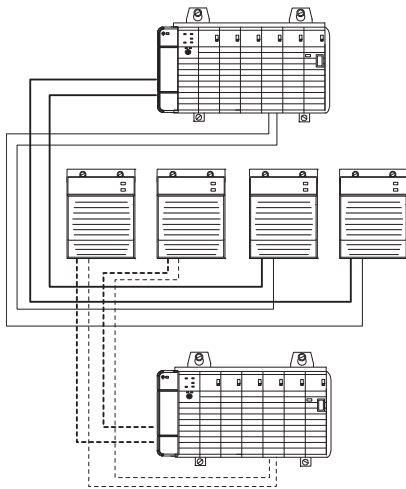

42658

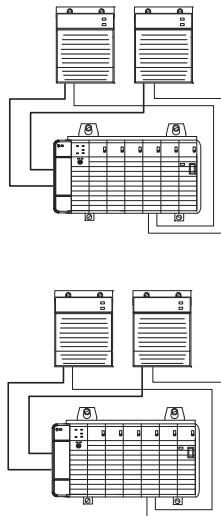

42655

1756-PA75R, 1756-PAXTR, 1756-PB75R, and 1756-PBXTR Mounting Dimensions

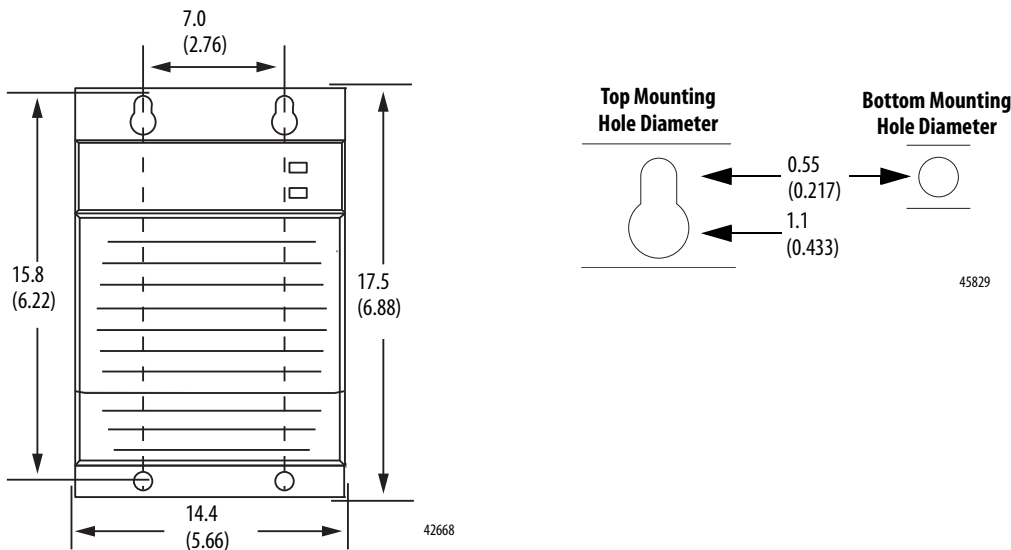

Dimensions are in cm (in.).

Redundant Power Supply Features

The redundant power supplies offer the same features as the standard power supplies, in addition to the following:

- Automatic chassis load sharing between the redundant power supplies
- Status indicators for visual operating status of the pair
- Solid-state relay for system recognition of supply status when wired to an input module

Table 10 - Technical Specifications - ControlLogix Redundant Power Supplies

Attribute	1756-PA75R	1756-PB75R
Input voltage range	85...265V AC ⁽¹⁾	18...32V DC ⁽²⁾
Input voltage	120V/240V AC, 50/60 Hz	24V DC
Input frequency range	47...63 Hz	DC
Input power, max	120VA 115 W	110 W
Output power, max	75 W @ 0...60 °C (32...140 °F)	
Hold-up time ⁽³⁾	2 cycles @ 60 Hz 2 cycles @ 50 Hz	20 ms
Inrush current, max	20 A	30 A
Current capacity at 1.2V	1.5 A	
Current capacity at 3.3V	4 A	
Current capacity at 5.1V	13 A	
Current capacity at 24V	2.8 A	
Annunciator power	240V AC 50/60 Hz, 240V DC, 50 mA, resistive only	
Overcurrent protection, max	User-supplied 15 A ⁽⁴⁾	
Fusing	Non-replaceable fuse is soldered in place ⁽⁵⁾	
Isolation voltage	250V (continuous), Reinforced Insulation Type, Power Input to Backplane, Power Input to Annunciator, Annunciator to Backplane Type tested at 3250V DC for 60 s	

Table 10 - Technical Specifications - ControlLogix Redundant Power Supplies

Attribute	1756-PA75R	1756-PB75R
Dimensions (HxWxD), approx	17.5 x 14.5 x 13.7 cm (6.9 x 5.7 x 5.4 in.)	
Weight, approx	1.45 kg (3.2 lb)	
Chassis	1756-A4, 1756-A7, 1756-A10, 1756-A13, 1756-A17	
Wire size	Power - 2.5 mm ² (14 AWG) solid or stranded copper wire rated at 90 °C (194 °F), or greater, 1.2 mm (3/64 in.) insulation max Annunciator - 0.25...2.5 mm ² (22...14 AWG) solid or stranded copper wire rated at 90 °C (194 °F), or greater, 1.2 mm (3/64 in.) insulation max	
Wire category ⁽⁶⁾	3 - on annunciator ports 1 - on power ports 3 - on 1756-CPR2 connections	
Pilot duty rating	Annunciator - not rated	
Conductor screw torque	0.79 N•m (7 lb•in)	
Solid-state relay contact	240V AC/DC ⁽⁷⁾	
North American temperature code	T3C	T4
IEC temperature code	T3	T4
Enclosure type rating	None (open-style)	

(1) UL certification for 120/240V AC, 50/60 Hz nominal. Rockwell Automation specified 85...265V AC, 47...63 Hz.

(2) UL certification for 24V DC nominal. Rockwell Automation specified 18...32V DC.

(3) The hold-up time is the time between input voltage removal and DC power failure.

(4) Use time-delay type overcurrent protection in all ungrounded conductors.

(5) This fuse is intended to guard against fire hazard due to short circuit conditions.

(6) Use this conductor category information for planning conductor routing. See the Industrial Automation Wiring and Grounding Guidelines, publication [1770-4.1](#).

(7) Do not exceed 50 mA; resistive only.

Table 11 - Environmental Specifications - Redundant Power Supplies

Attribute	1756-PA75R	1756-PB75R
Temperature, operating IEC 60068-2-1 (Test Ad, Operating Cold), IEC 60068-2-2 (Test Bd, Operating Dry Heat), IEC 60068-2-14 (Test Nb, Operating Thermal Shock)	0...60 °C (32...140 °F)	
Temperature, surrounding air, max	60 °C (140 °F)	
Temperature, nonoperating IEC 60068-2-1 (Test Ab, Unpackaged Nonoperating Cold), IEC 60068-2-2 (Test Bb, Unpackaged Nonoperating Dry Heat), IEC 60068-2-14 (Test Na, Unpackaged Nonoperating Thermal Shock)	-40...85 °C (-40...185 °F)	
Relative humidity IEC 60068-2-30 (Test Db, Unpackaged Damp Heat)	5...95% noncondensing	
Vibration IEC 60068-2-6 (Test Fc, Operating)	2 g @ 10...500 Hz	
Shock, operating IEC 60068-2-27 (Test Ea, Unpackaged Shock)	30 g	
Shock, nonoperating IEC 60068-2-27 (Test Ea, Unpackaged Shock)	50 g	
Emissions CISPR 11 (IEC 61000-6-4)	Class A	
ESD immunity IEC 61000-4-2	6 kV contact discharges 8 kV air discharges	
Radiated RF immunity IEC 61000-4-3	10V/m with 1 kHz sine-wave 80% AM from 80...2000 MHz 10V/m with 200 Hz 50% Pulse 100% AM @ 900 MHz 10V/m with 200 Hz 50% Pulse 100% AM at 1890 MHz 3V/m with 1 kHz sine-wave 80% AM from 2000...2700 MHz	
EFT/B immunity IEC 61000-4-4	±4 kV at 5 kHz on power ports ±4 kV at 5 kHz on annunciator ports	

Table 11 - Environmental Specifications - Redundant Power Supplies

Attribute	1756-PA75R	1756-PB75R
Surge transient immunity IEC 61000-4-5	±1 kV line-line (DM) and ±2 kV line-earth (CM) on power ports	
Conducted RF immunity IEC 61000-4-6	15V rms with 1 kHz sine-wave 80% AM from 150 kHz...80 MHz	
Voltage variation IEC 61000-4-11	30% dips for 1 period at 0° and 180° on AC supply ports 60% dips for 5 and 50 periods on AC supply ports ±10% fluctuations for 15 min on AC supply ports >95% interruptions for 250 periods on AC supply ports	N/A
Voltage variation IEC 61000-4-29	N/A	10 ms interruption on DC supply ports 60% dips for 100 ms on DC supply ports 100% dips for 50 ms on DC supply ports ±20% fluctuations for 15 min on DC supply ports 5 s interruptions on DC supply ports

Table 12 - Certifications - Redundant Power Supplies

Certification ⁽¹⁾	1756-PA75R	1756-PB75R
c-UL-us	UL Listed Industrial Control Equipment, certified for US and Canada. See UL File E65584. UL Listed for Class I, Division 2 Group A,B,C,D Hazardous Locations, certified for U.S. and Canada. See UL File E194810.	
CSA	CSA Certified Process Control Equipment. See CSA File LR54689C. CSA Certified Process Control Equipment for Class I, Division 2 Group A,B,C,D Hazardous Locations. See CSA File LR69960C.	
FM	FM Approved Equipment for use in Class I Division 2 Group A,B,C,D Hazardous Locations	
CE	European Union 2004/108/EC EMC Directive, compliant with: <ul style="list-style-type: none"> EN 61326-1; Meas./Control/Lab., Industrial Requirements EN 61000-6-2; Industrial Immunity EN 61000-6-4; Industrial Emissions EN 61131-2; Programmable Controllers (Clause 8, Zone A & B) European Union 2006/95/EC LVD, compliant with: <ul style="list-style-type: none"> EN 61131-2; Programmable Controllers (Clause 11) 	
RCM	Australian Radiocommunications Act, compliant with: <ul style="list-style-type: none"> EN 61000-6-4; Industrial Emissions 	
Ex	European Union 94/9/EC ATEX Directive, compliant with: <ul style="list-style-type: none"> EN 60079-15; Potentially Explosive Atmospheres, Protection "n" EN 60079-0; General Requirements II 3 G Ex nA IIC T4 Gc 	
KC	Korean Registration of Broadcasting and Communications Equipment, compliant with: <ul style="list-style-type: none"> Article 58-2 of Radio Waves Act, Clause 3 	

(1) When marked. See the Product Certification link at <http://www.ab.com> for Declarations of Conformity, Certificates, and other certification details.

Table 13 - Technical Specifications - ControlLogix-XT Redundant Power Supplies

Attribute	1756-PAXTR	1756-PBXTR
Input voltage range	85...265V AC ⁽¹⁾	18...32V DC
Input voltage	120V/240V AC	24V DC
Input frequency range	47...63 Hz	DC
Input power, max	75VA 65 W	75W
Output power, max	42 W @ 0...60 °C (32...140 °F)	
Hold-up time ⁽²⁾	2 cycles @ 60 Hz 2 cycles @ 50 Hz	20 ms
Inrush current, max	20 A	30 A
Current capacity at 1.2V	1.5 A	
Current capacity at 3.3V	4 A	
Current capacity at 5.1V	8 A	

Table 13 - Technical Specifications - ControlLogix-XT Redundant Power Supplies

Attribute	1756-PAXTR	1756-PBXTR
Current capacity at 24V	1.75 A	
Annunciator power	240V AC 50/60 Hz, 240V DC, 50 mA, resistive only	
Overcurrent protection, max	User-supplied 15 A ⁽³⁾	
Fusing	Non-replaceable fuse is soldered in place ⁽⁴⁾	
Isolation voltage	250V (continuous), Reinforced Insulation Type, Power Input to Backplane, Power Input to Annunciator, Annunciator to Backplane Type tested at 3250V DC for 60 s	
Dimensions (HxWxD), approx	17.5 x 14.5 x 13.7 cm (6.9 x 5.7 x 5.4 in.)	
Weight, approx	1.45 kg (3.2 lb)	
Chassis	1756-A4, 1756-A7, 1756-A10, 1756-A13, 1756-A17	
Wire size	Power - 2.5 mm ² (14 AWG) solid or stranded copper wire rated at 90 °C (194 °F), or greater, 1.2 mm (3/64 in.) insulation max Annunciator - 0.25...2.5 mm ² (22...14 AWG) solid or stranded copper wire rated at 90 °C (194 °F), or greater, 1.2 mm (3/64 in.) insulation max	
Wire category ⁽⁵⁾	1 - on power ports 3 - on annunciator ports 3 - on 1756-CPR2 connections	
Pilot duty rating	Annunciator - not rated	
Conductor screw torque	0.79 N•m (7 lb•in)	
Solid-state relay contact	240V AC/DC ⁽⁶⁾	
North American temperature code	T4A	
IEC temperature code	T4	
Enclosure type rating	None (open-style)	

(1) UL certification for 120/240V AC, 50/60 Hz nominal. Rockwell Automation specified 85...265V AC, 47...63 Hz.

(2) The hold-up time is the time between input voltage removal and DC power failure.

(3) Use time-delay type overcurrent protection in all ungrounded conductors.

(4) This fuse is intended to guard against fire hazard due to short circuit conditions.

(5) Use this conductor category information for planning conductor routing. See Industrial Automation Wiring and Grounding Guidelines, publication [1770-4.1](#).

(6) Do not exceed 50 mA; resistive only.

Table 14 - Environmental Specifications - XT Redundant Power Supplies

Attribute	1756-PAXTR	1756-PBXTR
Temperature, operating IEC 60068-2-1 (Test Ad, Operating Cold), IEC 60068-2-2 (Test Bd, Operating Dry Heat), IEC 60068-2-14 (Test Nb, Operating Thermal Shock)	-25...70 °C (13...158 °F)	
Temperature, surrounding air, max	70 °C (158 °F)	
Temperature, nonoperating IEC 60068-2-1 (Test Ab, Unpackaged Nonoperating Cold), IEC 60068-2-2 (Test Bb, Unpackaged Nonoperating Dry Heat), IEC 60068-2-14 (Test Na, Unpackaged Nonoperating Thermal Shock)	-40...85 °C (-40...185 °F)	
Relative humidity IEC 60068-2-30 (Test Db, Unpackaged Damp Heat)	5...95% noncondensing	
Vibration IEC 60068-2-6 (Test Fc, Operating)	2 g @ 10...500 Hz	
Shock, operating IEC 60068-2-27 (Test Ea, Unpackaged Shock)	30 g	
Shock, nonoperating IEC 60068-2-27 (Test Ea, Unpackaged Shock)	50 g	
Emissions CISPR 11 (IEC 61000-6-4)	Class A	
ESD immunity IEC 61000-4-2	6 kV contact discharges 8 kV air discharges	

Table 14 - Environmental Specifications - XT Redundant Power Supplies

Attribute	1756-PAXTR	1756-PBXTR
Radiated RF immunity IEC 61000-4-3	10V/m with 1 kHz sine-wave 80% AM from 80...1000 MHz 10V/m with 200 Hz 50% Pulse 100% AM @ 900 MHz 10V/m with 200 Hz 50% Pulse 100% AM at 1890 MHz 3V/m with 1 kHz sine-wave 80% AM from 2000...2700 MHz	
EFT/B immunity IEC 61000-4-4	±4 kV at 5 kHz on power ports ±4 kV at 5 kHz on annunciator ports	
Surge transient immunity IEC 61000-4-5	±1 kV line-line (DM) and ±2 kV line-earth (CM) on power ports	
Conducted RF immunity IEC 61000-4-6	15V rms with 1 kHz sine-wave 80% AM from 150 kHz...80 MHz	
Voltage variation IEC 61000-4-11	30% dips for 1 period at 0° and 180° on AC supply ports 60% dips for 5 and 50 periods on AC supply ports ±10% fluctuations for 15 min on AC supply ports >95% interruptions for 250 periods on AC supply ports	N/A
Voltage variation IEC 61000-4-29	N/A	10 ms interruption on DC supply ports 60% dips for 100 ms on DC supply ports 100% dips for 50 ms on DC supply ports ±20% fluctuations for 15 min on DC supply ports 5 s interruptions on DC supply ports

Table 15 - Certifications - XT Redundant Power Supplies

Certification ⁽¹⁾	1756-PAXTR	1756-PBXTR
c-UL-us	UL Listed Industrial Control Equipment, certified for US and Canada. See UL File E65584. UL Listed for Class I, Division 2 Group A,B,C,D Hazardous Locations, certified for U.S. and Canada. See UL File E194810.	
CE	European Union 2004/108/EC EMC Directive, compliant with: <ul style="list-style-type: none"> EN 61326-1; Meas./Control/Lab., Industrial Requirements EN 61000-6-2; Industrial Immunity EN 61000-6-4; Industrial Emissions EN 61131-2; Programmable Controllers (Clause 8, Zone A & B) European Union 2006/95/EC LVD, compliant with: <ul style="list-style-type: none"> EN 61131-2; Programmable Controllers (Clause 11) 	
RCM	Australian Radiocommunications Act, compliant with: <ul style="list-style-type: none"> EN 61000-6-4; Industrial Emissions 	
Ex	European Union 94/9/EC ATEX Directive, compliant with: <ul style="list-style-type: none"> EN 60079-15; Potentially Explosive Atmospheres, Protection "n" EN 60079-0; General Requirements II 3 G Ex nA IIC T4 Gc X 	
KC	Korean Registration of Broadcasting and Communications Equipment, compliant with: <ul style="list-style-type: none"> Article 58-2 of Radio Waves Act, Clause 3 	

(1) When marked. See the Product Certification link at <http://www.ab.com> for Declarations of Conformity, Certificates, and other certification details.

Redundant Power Supply Chassis Adapter Module

Table 16 - Technical Specifications - Redundant Power Supplies Chassis Adapter Module

Attribute	1756-PSCA2	1756-PSCA2XT
Current capacity at 1.2V DC	1.5 A	
Current capacity at 3.3V DC	4 A	
Current capacity at 5.1V DC	15 A	
Current capacity at 24V DC	2.8 A	
Wire category ⁽¹⁾	3 - on 1756-CPR2 connections	

Table 16 - Technical Specifications - Redundant Power Supplies Chassis Adapter Module

Attribute	1756-PSCA2	1756-PSCA2XT
North American temperature code	T5	T4A
IEC temperature code	T5	T4
Enclosure type rating	None (open-style)	

(1) Use this conductor category information for planning conductor routing. See the Industrial Automation Wiring and Grounding Guidelines, publication [1770-4.1](#).

Table 17 - Environmental Specifications - Redundant Power Supplies Chassis Adapter Module

Attribute	1756-PSCA2	1756-PSCA2XT
Temperature, operating IEC 60068-2-1 (Test Ad, Operating Cold), IEC 60068-2-2 (Test Bd, Operating Dry Heat), IEC 60068-2-14 (Test Nb, Operating Thermal Shock)	0...60 °C (32...140 °F)	-25...70 °C (-13...158 °F)
Temperature, surrounding air, max	60 °C (140 °F)	70 °C (158 °F)
Temperature, nonoperating IEC 60068-2-1 (Test Ab, Unpackaged Nonoperating Cold), IEC 60068-2-2 (Test Bb, Unpackaged Nonoperating Dry Heat), IEC 60068-2-14 (Test Na, Unpackaged Nonoperating Thermal Shock)	-40...85 °C (-40...185 °F)	
Relative humidity IEC 60068-2-30 (Test Db, Unpackaged Damp Heat)	5...95% noncondensing	
Vibration IEC 60068-2-6 (Test Fc, Operating)	2 g @ 10...500 Hz	
Shock, operating IEC 60068-2-27 (Test Ea, Unpackaged Shock)	30 g	
Shock, nonoperating IEC 60068-2-27 (Test Ea, Unpackaged Shock)	50 g	
Emissions CISPR 11 (IEC 61000-6-4)	Class A	
ESD immunity IEC 61000-4-2	6 kV contact discharges 8 kV air discharges	
Radiated RF immunity IEC 61000-4-3	10V/m with 1 kHz sine-wave 80% AM from 80...2000 MHz 10V/m with 200 Hz 50% Pulse 100% AM at 900 MHz 10V/m with 200 Hz 50% Pulse 100% AM at 1890 MHz 3V/m with 1 kHz sine-wave 80% AM from 2000...2700 MHz	

Table 18 - Certifications - Redundant Power Supplies Chassis Adapter Module

Certification ⁽¹⁾	1756-PSCA2	1756-PSCA2XT
c-UL-us	UL Listed Industrial Control Equipment, certified for US and Canada. See UL File E65584. UL Listed for Class I, Division 2 Group A,B,C,D Hazardous Locations, certified for U.S. and Canada. See UL File E194810.	
CSA	CSA Certified Process Control Equipment. See CSA File LR54689C. CSA Certified Process Control Equipment for Class I, Division 2 Group A,B,C,D Hazardous Locations. See CSA File LR69960C.	N/A
FM	FM Approved Equipment for use in Class I Division 2 Group A,B,C,D Hazardous Locations	N/A
CE	European Union 2004/108/EC EMC Directive, compliant with: <ul style="list-style-type: none"> EN 61326-1; Meas./Control/Lab., Industrial Requirements EN 61000-6-2; Industrial Immunity EN 61000-6-4; Industrial Emissions EN 61131-2; Programmable Controllers (Clause 8, Zone A & B) 	

Table 18 - Certifications - Redundant Power Supplies Chassis Adapter Module

RCM	Australian Radiocommunications Act, compliant with: <ul style="list-style-type: none"> • EN 61000-6-4; Industrial Emissions
Ex	European Union 94/9/EC ATEX Directive, compliant with: <ul style="list-style-type: none"> • EN 60079-15; Potentially Explosive Atmospheres, Protection "n" • EN 60079-0; General Requirements • II 3 G Ex nA IIC T5 Gc X
KC	Korean Registration of Broadcasting and Communications Equipment, compliant with: <ul style="list-style-type: none"> • Article 58-2 of Radio Waves Act, Clause 3

(1) When marked. See the Product Certification link at <http://www.ab.com> for Declarations of Conformity, Certificates, and other certification details.

Power Load and Transformer Sizing

The following graphs show the input power requirements for the power supplies, given the power they are providing to the modules in the chassis.

Follow these steps to determine the power requirements for your chassis.

1. Calculate the Backplane Power Load by adding the power draw (in Watts) for all of the planned modules.

For module power draws, refer to the module specification tables in the ControlLogix Selection Guide, publication [1756-SG001](#).

2. Locate the Backplane Power Load on the graph's vertical (y) axis and determine the corresponding Real Power (input-power) rating on the horizontal (x) axis.

The Real Power value is the amount of power consumed by the power supply.

Power Supply Power Requirements

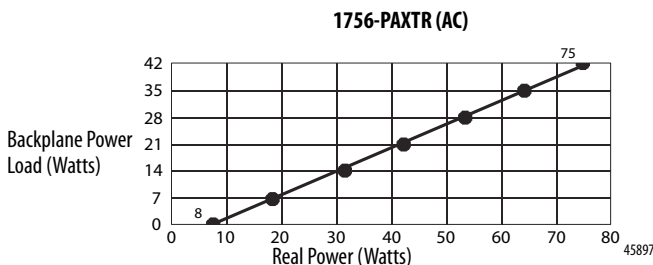
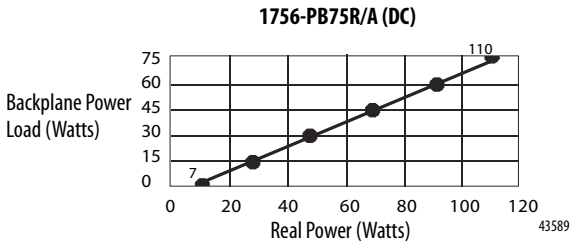
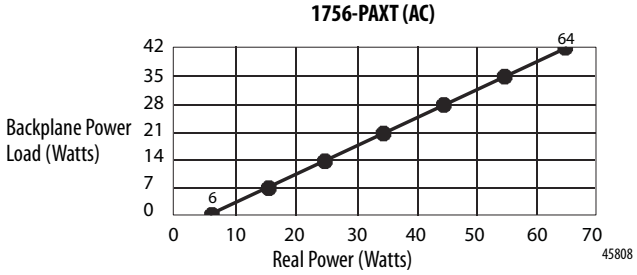
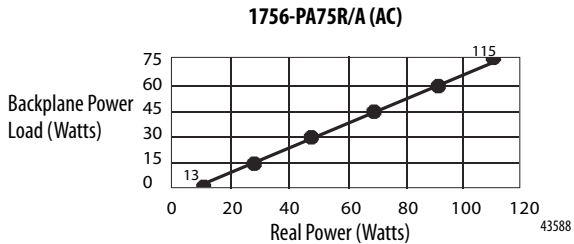
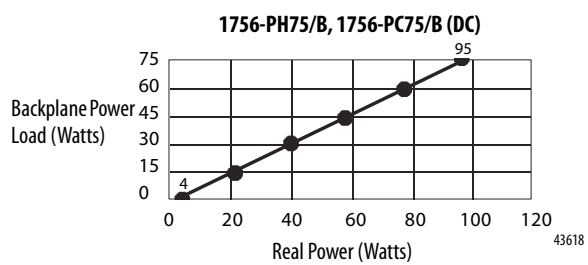
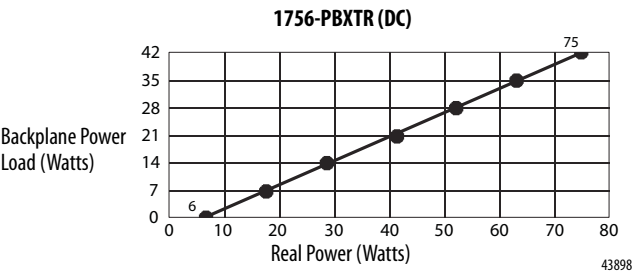
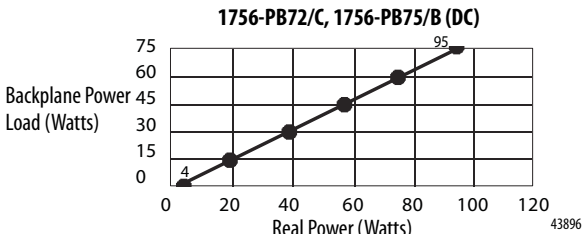
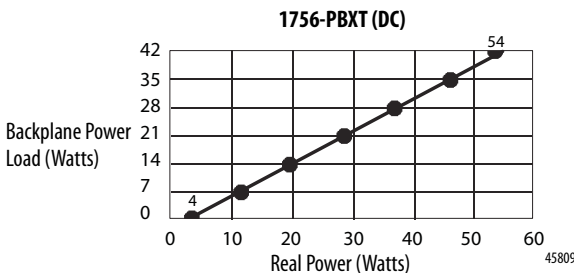
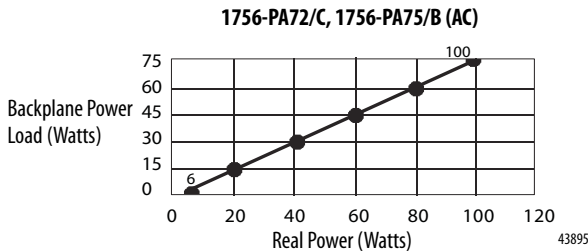

Apparent Power (Watts) = Transformer Load (VA) = Real Power (Watts)

Additional Resources

These documents contain additional information concerning related products from Rockwell Automation.

Resource	Description
ControlLogix Selection Guide, publication 1756-SG001	Provides overview of the ControlLogix system and its products.
ControlLogix Chassis Specifications Technical Data, publication 1756-TD006	Provides technical specifications for ControlLogix chassis.
ControlLogix Chassis and Power Supplies Installation Instructions, publication 1756-IN005	Provides planning and installation information for the ControlLogix chassis and power supplies.
ControlLogix System User Manual, publication 1756-UM001	Provides information on how to install, configure, program, and use ControlLogix systems.
Industrial Automation Wiring and Grounding Guidelines, publication 1770.4.1	Provides general guidelines for installing a Rockwell Automation® industrial system.
Product Certifications website, http://www.ab.com	Provides declarations of conformity, certificates, and other certification details.

You can view or download publications at <http://www.rockwellautomation.com/literature/>. To order paper copies of technical documentation, contact your local Allen-Bradley distributor or Rockwell Automation sales representative.

Notes:

Important User Information

Read this document and the documents listed in the additional resources section about installation, configuration, and operation of this equipment before you install, configure, operate, or maintain this product. Users are required to familiarize themselves with installation and wiring instructions in addition to requirements of all applicable codes, laws, and standards.

Activities including installation, adjustments, putting into service, use, assembly, disassembly, and maintenance are required to be carried out by suitably trained personnel in accordance with applicable code of practice.

If this equipment is used in a manner not specified by the manufacturer, the protection provided by the equipment may be impaired.

In no event will Rockwell Automation, Inc. be responsible or liable for indirect or consequential damages resulting from the use or application of this equipment.

The examples and diagrams in this manual are included solely for illustrative purposes. Because of the many variables and requirements associated with any particular installation, Rockwell Automation, Inc. cannot assume responsibility or liability for actual use based on the examples and diagrams.

No patent liability is assumed by Rockwell Automation, Inc. with respect to use of information, circuits, equipment, or software described in this manual.

Reproduction of the contents of this manual, in whole or in part, without written permission of Rockwell Automation, Inc., is prohibited.

Documentation Feedback

Your comments will help us serve your documentation needs better. If you have any suggestions on how to improve this document, complete this form, publication [RA-DU002](#), available at <http://www.rockwellautomation.com/literature/>.

Allen-Bradley, Rockwell Software, Rockwell Automation, ControlLogix, ControlLogix-XT, FLEX I/O-XT, and LISTEN. THINK. SOLVE are trademarks of Rockwell Automation, Inc. Trademarks not belonging to Rockwell Automation are property of their respective companies.

Rockwell Otomasyon Ticaret A.Ş., Kar Plaza İş Merkezi E Blok Kat:6 34752 İçerenköy, İstanbul, Tel: +90 (216) 5698400

www.rockwellautomation.com

Power, Control and Information Solutions Headquarters

Americas: Rockwell Automation, 1201 South Second Street, Milwaukee, WI 53204-2496 USA, Tel: (1) 414.382.2000, Fax: (1) 414.382.4444
Europe/Middle East/Africa: Rockwell Automation NV, Pegasus Park, De Kleetlaan 12a, 1831 Diegem, Belgium, Tel: (32) 2 663 0600, Fax: (32) 2 663 0640
Asia Pacific: Rockwell Automation, Level 14, Core F, Cyberport 3, 100 Cyberport Road, Hong Kong, Tel: (852) 2887 4788, Fax: (852) 2508 1846