

Power Distribution & Terminal Blocks

Connector-Stud and Stud-Stud Blocks

600Vac/dc

Cross Reference RA Part Number 22187-043-01



Catalog Symbol: Connector-Stud Block
Voltage Rating: 600Vac/dc maximum
SCCR: 10kA (except for select products noted)
Agency Information:
 UL Recognized, Guide XCFR2, File E221592
 CSA Certified, Class 6228-01, File 15364
Series 162, 163, and 165 Dimensional Data
(Available 1, 2, and 3 pole)

Series 160 (Available 2, 3, and 4 pole)
Dimensional Data

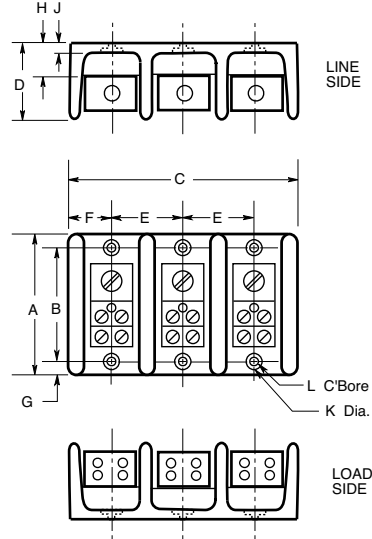
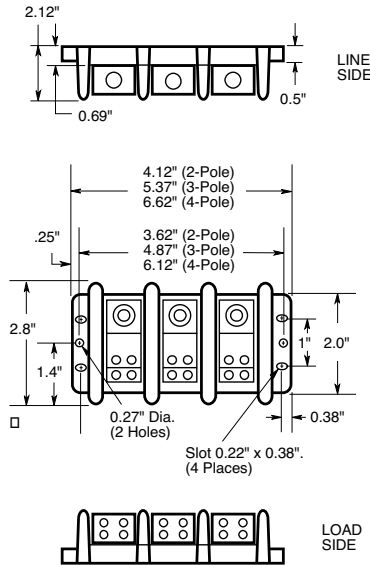

Dimensions for Series 162, 163, and 165

Cat. No.	A	B	C1	C2	C3	D	E	F	G	H	J	K	L
162	2.88	2.25	1.07	1.88	2.70	1.75	0.81	0.53	0.31	0.84	0.31	0.20	0.41
163	4.0	3.38	1.98	3.60	5.21	3.32	1.62	0.99	0.31	0.87	0.35	Slot .20" wide x .41" long	Slot .42" wide x .62" long
165	5.5	4.75	3.10"	5.79"	8.48"	2.93"	2.69	1.55"	0.38	1.19"	.44"	Slot .20" wide x .33" long	Slot .41" wide x .53" long

160 Series Bases have mounting holes outside the barriers. Other bases (162 through 165) have mounting holes within barriers—see dimensional drawings.

Connector-Stud Blocks (600V) Catalog Data

Catalog Number	1-Pole	2-Pole	3-Pole	Connection		Connector Material and Ampacity	UL	CSA
				Line	Load			
Connector - Stud								
16280*	-1	-2	-3	2/0 - #14CU-AL	¼ - 20 x ¾ Stud	AL-175A	•	—
16281	-1	-2	-3	2/0 - #14CU-AL	¼ - 20 Tapped hole	AL-175A	•	—
16378	-1	-2	-3	500kcmil - #6CU-AL	(2) ¼ - 20 x 1 Stud	AL-380A	•	•
16383	-1	-2	-3	500kcmil - #6CU-AL	(1) ⅜ - 16 x 1 Stud	AL-380A	•	•
16582	-1	-2	-3	(2) 500kcmil - #6CU-AL	(2) ⅜ - 16 x 1½ Stud	AL-760A	•	•
Stud - Stud								
16290	-1	-2	-3	¼ - 20 x ¾ Stud	¼ - 20 x ¾ Stud	CU-150A	•	—
16390	-1	-2	-3	⅜ - 16 x 1⅛ Stud	⅜ - 16 x 1⅛ Stud	CU-250A	•	•
16394	-1	-2	-3	½ - 13 x 1⅛ Stud	½ - 13 x 1⅛ Stud	CU-400A	•	•
16395	-1	-2	-3	⅜ - 16 x 1⅛ Stud	(2) ¼ - 20 x ⅞ Stud	CU-310A	•	•
16591	-1	-2	-3	⅜ - 16 x 1⅛ Stud	(2) ⅜ - 16 x 1⅛ Stud	CU-400A	•	—
16593	-1	-2	-3	½ - 13 x 1 Stud	½ - 13 x 1 Stud	CU-600A	•	•

*SCCR up to 200kA

The only controlled copy of this Data Sheet is the electronic read-only version located on the Cooper Bussmann Network Drive. All other copies of this document are by definition uncontrolled. This bulletin is intended to clearly present comprehensive product data and provide technical information that will help the end user with design applications. Cooper Bussmann reserves the right, without notice, to change design or construction of any products and to discontinue or limit distribution of any products. Cooper Bussmann also reserves the right to change or update, without notice, any technical information contained in this bulletin. Once a product has been selected, it should be tested by the user in all possible applications.