

Product Details and Certifications

 RA Part Number: **25645-023-09**

Description: Current Transformer Model 567TS, Ratio 1000:5



Representative Photo Only (actual product may vary based on configuration selections)

CURRENT TRANSFORMER DATA

Current Ratio	1000:5 A
Frequency	50-400 Hz
Insulation Level	600 Volts

CERTIFICATIONS AND APPROVALS

CSA	LR89403
CURUS	E93779

CURRENT TRANSFORMERS

Models 567TL, 567TS

Window Size 4.75" X 3.75"

APPLICATION:
Metering.

FREQUENCY:
50-400 Hz.

INSULATION LEVEL:
0.6 kV, BIL 10 kV full wave.

CONTINUOUS THERMAL RATING FACTOR:
1.33 at 30°C. amb.
1.0 at 55°C. amb.

- TL-Terminals are brass studs No. 10-32 with one flatwasher, lockwasher and regular nut.
- TS-Terminals are brass screws No. 10-32 with one flatwasher.
- Approximate weight 4 lbs.

REGULATORY AGENCY APPROVALS



E93779



LR89403

Manufactured to meet the requirements of ANSI/IEEE C57.13.
Classified by U.L. in accordance with IEC 44-1

Model 567TL

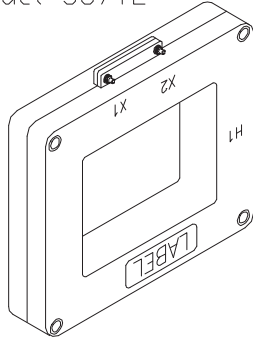

Model 567TS

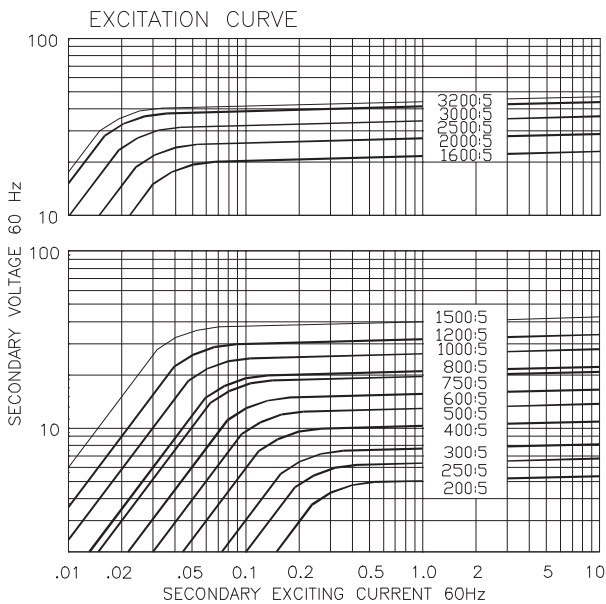
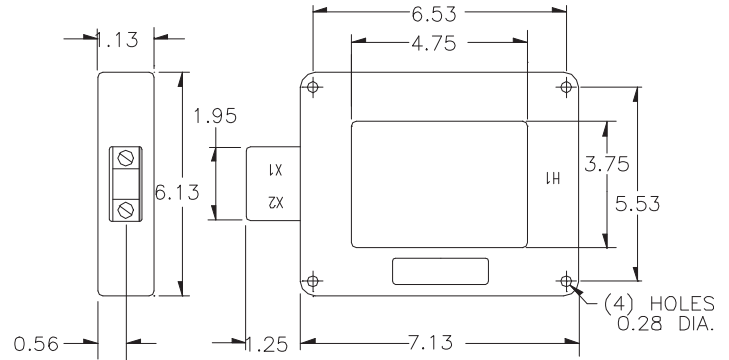
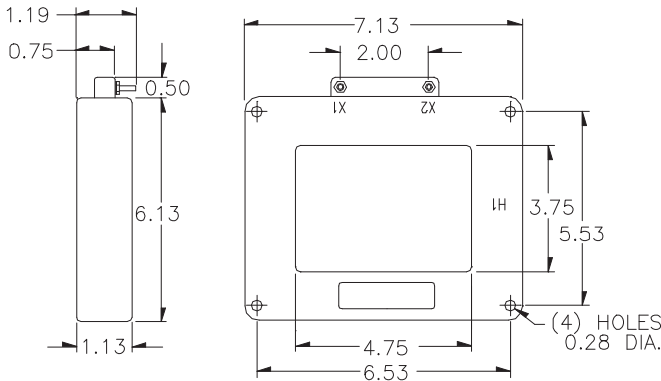
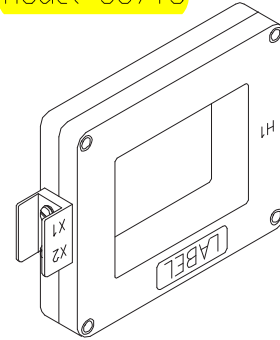

CATALOG NUMBER	CURRENT RATIO	ANSI METERING CLASS AT 60 Hz					SECONDARY WINDING RESISTANCE (OHMS @ 75°C)
		B0.1	B0.2	B0.5	B0.9	B1.8	
567**201	200:5	2.4	2.4	-	-	-	0.038
567**251	250:5	1.2	2.4	-	-	-	0.048
567**301	300:5	1.2	1.2	2.4	-	-	0.061
567**401	400:5	0.6	1.2	2.4	2.4	-	0.078
567**501	500:5	0.6	0.6	1.2	2.4	-	0.098
567**601	600:5	0.6	0.6	1.2	1.2	2.4	0.117
567**751	750:5	0.3	0.6	0.6	1.2	2.4	0.147
567**801	800:5	0.3	0.6	0.6	1.2	1.2	0.157
567**102	1000:5	0.3	0.3	0.6	0.6	1.2	0.196
567**122	1200:5	0.3	0.3	0.3	0.6	0.6	0.235
567**152	1500:5	0.3	0.3	0.3	0.3	0.6	0.368
567**162	1600:5	0.3	0.3	0.3	0.6	0.6	0.264
567**202	2000:5	0.3	0.3	0.3	0.3	0.6	0.330
567**252	2500:5	0.3	0.3	0.3	0.3	0.3	0.413
567**302	3000:5	0.3	0.3	0.3	0.3	0.3	0.616
567**322	3200:5	0.3	0.3	0.3	0.3	0.3	0.657

**NOTE: When ordering, prefix Cat. No. with model designation required i.e., 567TL-201 or 567TS-201.