

PK-2

Test Blocks and Plugs



(Photo 851894)
Fig. 1. 4-pole block with cover



(Photo 851891)
Fig. 2. 4-pole test plug

APPLICATION

For mounting on switchboard panels for use in conjunction with proper test equipment to facilitate the testing of ac instruments, meters and relays.

FEATURES

Type PK-2 test blocks are essentially 4-pole and 6-pole jacks, provided with molded Textolite covers that have internal plug contacts, which make a through connection when the cover is in place. The contacts in the blocks are of the line-pressure type and provide positive contact with minimum contact resistance. For all current circuits, auxiliary contacts are used which automatically short circuit the current transformer when the cover, or plug is removed.

The test plugs, provided with studs and links, can be permanently connected to the testing equipment for any of the various test methods in use.

Routine testing can be accomplished simply by removing the cover and substituting the properly connected test plug; normal connections are restored by replacing the cover. Contact rating is 250 volts, 10 amperes continuously.

EXPLANATION OF LISTING

The Cat. No. for each form of block includes the PK-2 block and cover with a set of unmounted auxiliary contacts, jumpers, and screws in sufficient variety and quantity to provide the combinations to suit any application desired, typical arrangements of which are shown in Fig. 10 to 15 inclusive. The Cat. No. and price include mounting screws, nuts for the studs, and (for blocks for mounting on 1/8-1/2-inch panels) bushings for the studs. Test links for test plug are supplied with the plug: 4 with the 4-pole, 6 with the 6-pole.

PK-2 Test Blocks with Covers

FOUR-POLE			SIX-POLE		
Catalog No. ①		Net Wt in Lb	Catalog No. ①		Net Wt in Lb
Surface Mounting on 1-, 1 1/2-, 2-in. Panels (Fig. 3 and 5)	Semiflush Mounting On 1/8-in. Panels or Surface Mounting on 1/8- to 1/2-in. Panels (Fig. 3 and 6 or 7)		Surface Mounting on 1-, 1 1/2-, 2-in. Panels (Fig. 4 and 5)	Semiflush Mounting on 1/8-in. Panels or Surface Mounting on 1/8- to 1/2-in. Panels (Fig. 4 and 6 or 7)	
6422120G1	6422120G3	2	6422120G2	6422120G4	3

① Auxiliary contacts, jumpers, screws, mounting screws, and bushings, as required, included in Cat. No. and price.

Test Plugs (Fig. 2 and 8)

FOUR-POLE		SIX-POLE	
Catalog No.	Net Wt in Lb	Catalog No.	Net Wt in Lb
6129533G1	1 1/4	6129533G2	1 3/4

DIMENSIONS (subject to change and not to be used for construction without approval.)

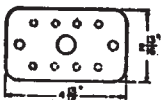

Fig. 3. 4 Pole

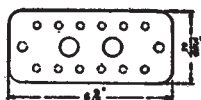

Fig. 4. 6 Pole

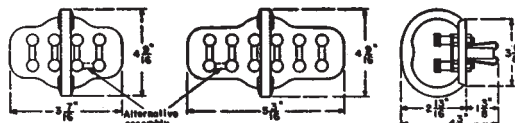

Fig. 8. 4- and 6-pole studs

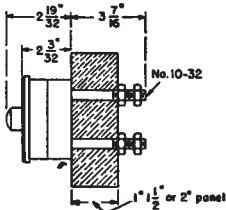

Fig. 5. 4- or 6-pole surface mounted on 1- to 2-in panel

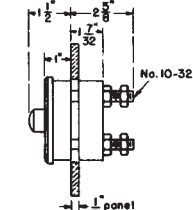

Fig. 6. Semiflush mounted on 1/8-in. panel

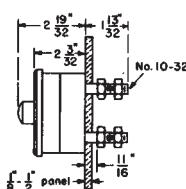

Fig. 7. Surface mounted on 1/8- to 1/2-in. panel

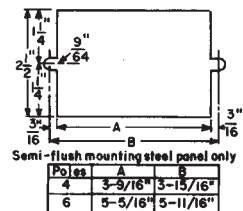

Fig. 9. Semi-flush mounting steel panel only



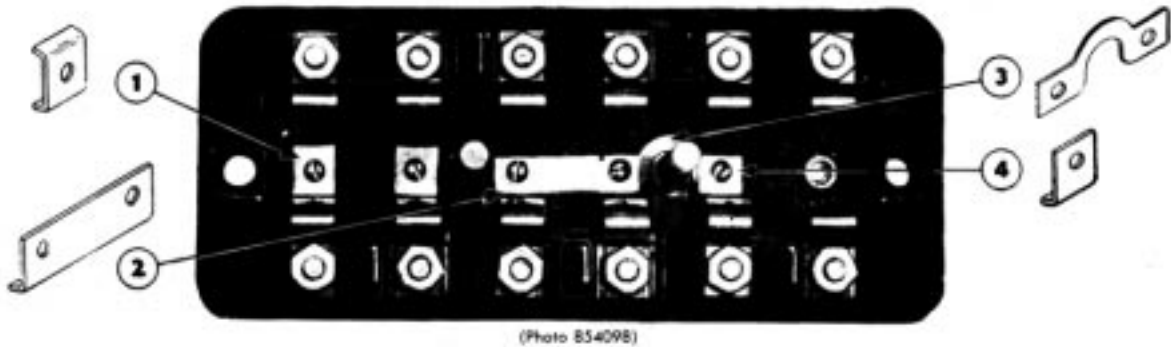

Fig. 9 shows a composite assembly of a 6-pole PK-2 test block with auxiliary contacts and jumpers, as follows:

- No.1— Auxiliary contact (Cat. No. 6179685G3) used as a bridge to maintain the circuit during the period that the cover or the plug is not in place. Without this connection, loss of revenue is possible because of interrupted operation if the replacement of the cover, or plug, is long delayed.
- No. 2— Auxiliary contact (Cat. No. 6179685G2) to short circuit the current transformer when the cover or plug is not in place.
- No.3— Jumper (Cat. No. 6179685G4) to be used in connection with auxiliary contact No. 2 or No. 4, to serve the same purpose as No. 2 in short circuiting a current transformer, or to interconnect phases, when the cover-fastening stud is to be by-passed.
- No. 4— Auxiliary contact (Cat. No. 6179685G1) equal to one pole of contact No. 2, to be used in connection with jumper No. 3 as shown in Fig. 9. If all poles are to be

TYPICAL ARRANGEMENTS OF TYPE PK-2 TEST BLOCKS WITH AUXILIARY CONTACTS AND JUMPERS

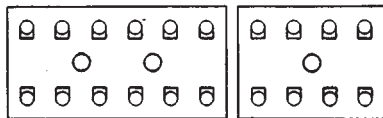

Fig. 10. Without auxiliary contacts, for potential circuits

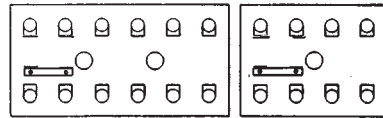

Fig. 11. With one auxiliary contact No. 2, for connections as shown in Fig. 16 and 19, page 13-23

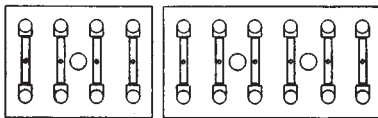

Fig. 12. With auxiliary contacts No. 1, for through-current connections

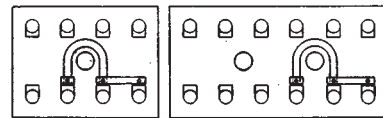

Fig. 13. With auxiliary contacts No. 2 and 4, and jumper No. 3, for relay and trip connections

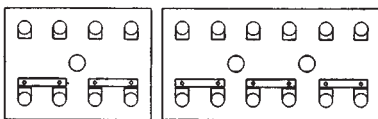

Fig. 14. With auxiliary contacts No. 2, for current circuits

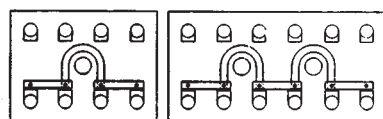

Fig. 15. With auxiliary contacts No. 2 and jumpers No. 3, for current transformer short circuiting

The above shown auxiliary contacts and jumpers are furnished, with the purchase of the PK-2 blocks, as follows:

- | | | | |
|-----------------|---------------|-----------------|---------------|
| 6422120G1 or G3 | (1) 6179685G1 | 6422120G2 or G4 | (1) 6179685G1 |
| | (2) 6179685G2 | | (3) 6179685G2 |
| | (4) 6179685G3 | | (6) 6179685G3 |
| | (1) 6179685G4 | | (2) 6179685G4 |

Jumpers and auxiliary contacts are available as a separate item, only as follows:

- | | |
|-----------|---------------|
| 6422120G8 | (1) 6179685G1 |
| | (3) 6179685G2 |
| | (6) 6179685G3 |
| | (2) 6179685G4 |

Control Switches and Accessories

SCHEMATIC CONNECTIONS (BACK VIEW)

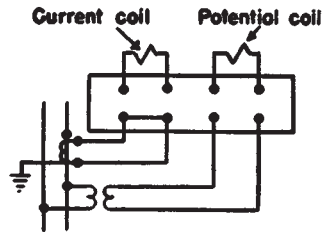

Fig. 16. Test-block connection for one current and one potential coil

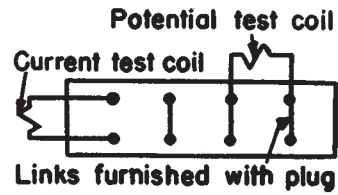

Fig. 17. Plug connection for Fig. 16 for testing one current and one potential coil in circuit

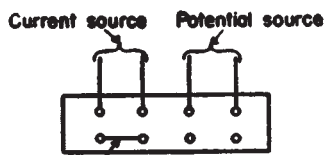

Fig. 18. Plug connection for Fig. 16 for testing one current and one potential coil with separate source

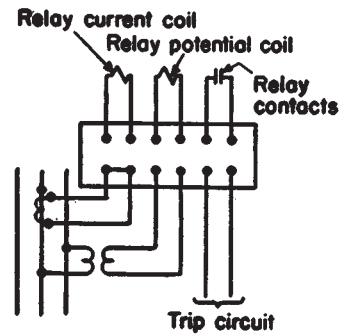

Fig. 19. Test-block connection for one current and one potential coil with connection for trip circuit

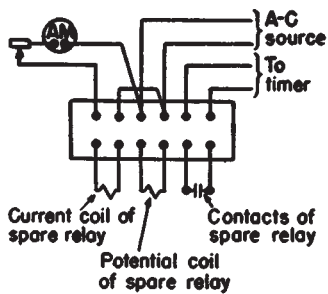

Fig. 20. Plug connection for Fig. 19 for separate test of relay with separate source and spare relay for protection while testing

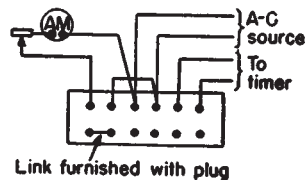

Fig. 21. Plug connection for Fig. 19 for separate test of relay with separate source

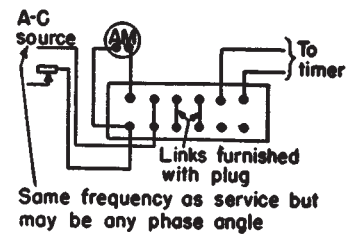

Fig. 22. Plug connection for Fig. 19 for testing relay with same or separate source