

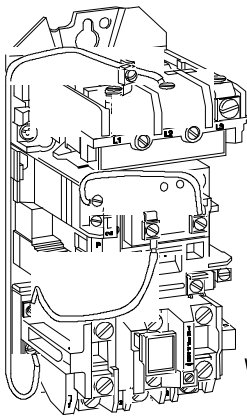

Bulletin 509 3-Phase Full Voltage NEMA Starters with Eutectic Alloy and SMP™ Solid-state Overload Relays Sizes 0 through 4 (all series), Size 5 (series L)

Renewal Parts



Size 1
with Eutectic Alloy
Overload Relay

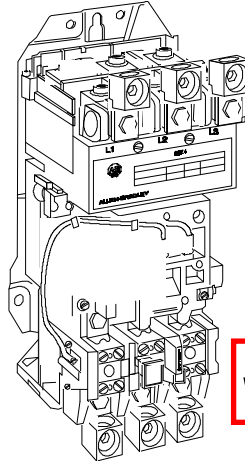

Size 3
with Eutectic Alloy
Overload Relay

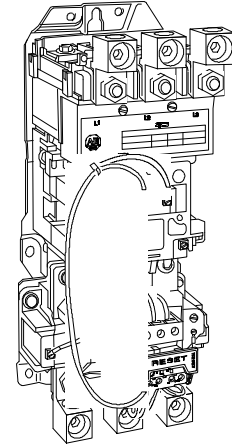

Size 5
with SMP-1
Solid-state
Overload Relay

Important: Save renewal parts list for future reference.

Table of Contents

Description	2
Renewal Parts	3
Operating Coils	4
Coil Data	4
SMP Solid-state Overload Relay	5
Disassembly	7
Replacing Contacts	7
Movable Contacts	8
Front Stationary Contacts	8
Rear Stationary Contacts	9
Replacing the Stationary Contact Block and Base Assembly	9
Reassembly	10
Eutectic Alloy Overload Relay Test Module	10
Replacing the Eutectic Alloy Overload Relay	11
Replacing the SMP Solid-state Overload Relay	11
Replacing Current Transformer	12
Modifications	14
Auxiliary Contacts	14
Removal of Auxiliary Contact Block	14
Installing or Replacing an Auxiliary Contact Block	15
Auxiliary Contact for Eutectic Alloy Overload Relay	16
Installing (N.O. or N.C) Auxiliary Contact for Eutectic Alloy Overload Relay	16
Adding an N.O. or N.C. Auxiliary Contact in Place of Circuit Test module on Eutectic Alloy Overload Relay for Sizes 3 and 4 Starters	17
Replacing an N.O or N.C. Auxiliary Contact on an Overload Relay (for sizes 3 and 4 Starters)	19

Renewal Parts

Bulletin 509, Sizes 0 through 4 (all series)
Size 5 (series L)

Description

Bulletin 509 starters are designed for full voltage starting of polyphase squirrel cage motors. These starters meet NEMA standards, are easy to wire and service, simple to select, and offer Class 10, 15, 20, and 30 overload protection in the complete range of NEMA sizes 00 to 9.

These starters may be operated with push buttons, float switches, thermostats, pressure switches, snap switches, limit switches, or any other suitable two or three wire pilot device.

All Bulletin 509 starters are available with Bulletin 592 eutectic alloy overload relays as well as Smart Motor Protectors (SMPs) - Solid-state Overloads for additional flexibility in motor protection.



ATTENTION: To prevent electrical shock, disconnect from power source before installing or servicing. Install in suitable enclosure. Keep free from contaminants.

Starters can be disassembled as depicted in the “exploded” illustration, Figure 1.

Primary parts illustrated are similar in appearance for all sizes. Secondary parts such as mounting plate, overload relays, etc. will vary in appearance.

Figure 1

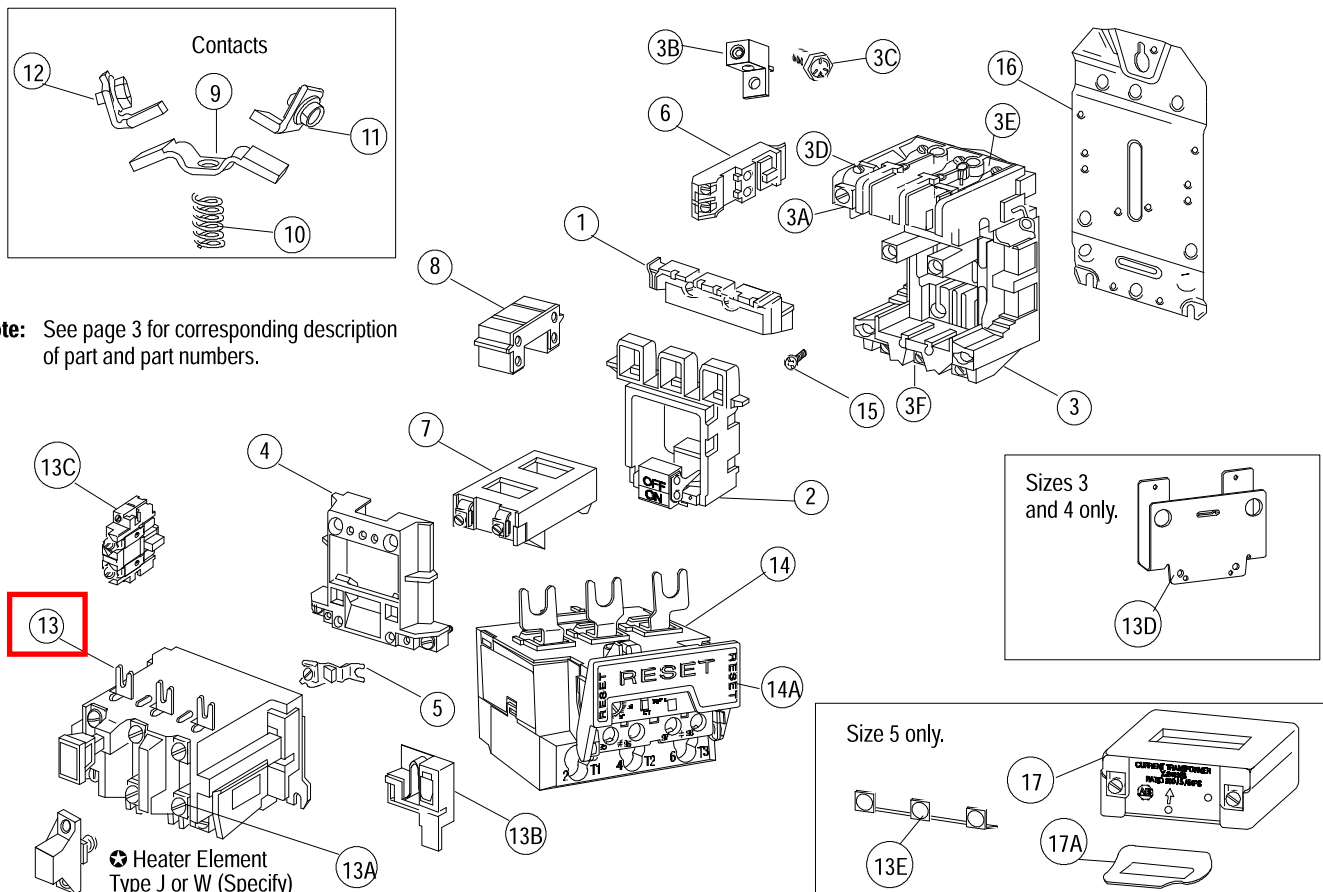

Renewal Parts

Bulletin 509, Sizes 0 through 4 (all series)
Size 5 (series L)

Renewal Parts

Item	Description of Renewal Parts	Size 0	Size 1	Size 2	Size 3	Size 4	Size 5 (Series L)Ⓐ
		Part No.	Part No.	Part No.	Part No.	Part No.	Part No.
1	Contact Block Cover	40410-499-01	40410-499-02	40420-499-01	40430-457-51	40440-456-51	42450-800-01
2Ⓑ	Movable Contact Support and Armature Assembly	40410-498-01 Series A 40410-498-03 Series B		40420-498-01	40430-452-51	40440-453-51	42450-801-01
3Ⓑ	Stationary Contact Block and Base Assembly	40410-494-03	40410-494-04	40420-495-02	40430-462-52	40440-462-52	42450-307-62
3A	Saddle Clamp Assembly (for size 0 and 1)	X-225492		—	—	—	—
3B	Lug	—	—	X-316012	40430-461-51	40440-461-51	42450-804-01
3C	Bolt	—	—	M-6289	M-6532	M-6834	—
3D	Front Terminal without Contact	Ⓒ	Ⓒ	Ⓒ	40430-022-02	40440-030-02	42450-302-52
3E	Rear Terminal without Contact				40430-024-02	40440-314-51	40440-314-51
3F	Front/Rear Terminal Screw				28168-107-26	28168-502-26	Ⓓ
4	Coil Cover	40410-496-01		40420-497-01	40430-454-51	40440-454-51	42450-803-01
5	Tie Point Terminal	599-TP02			599-TP34		
6	Auxiliary Contact Block (refer to page 14)	Ⓔ 595-A (used as hold-in contact)					
7	Operating Coil	See Table on page 4					
8	Yoke (50-60 Hz)	Ⓔ 40410-497-01	Ⓔ 40410-497-02	Ⓔ 40430-455-51	Ⓔ 40440-458-51		
9	Movable Contact	Order Single Pole Contact Set					
10	Contact Spring						
11	Front Stationary Contact						
12	Rear Stationary Contact						
9-12	Single Pole Contact Set (includes (1) each item 9-12)	Ⓔ 40410-331-51	Ⓔ 40410-331-52	Ⓔ 40420-322-51	Ⓔ 40430-300-51	Ⓔ 40440-300-51	Ⓔ 42450-805-01
13	Eutectic Alloy Overload Relay (includes item 13B test module)	42185-800-01		40185-800-01	40185-801-01	40185-802-01	Ⓔ 592-80V16Ⓔ
13A	Eutectic Alloy Heater Element Screw	M-1552					
13B	Test Module (included with item 13 overload relay)	40185-499-01			40430-459-51		42450-807-01
13C	Overload Relay Auxiliary Contact (included with item 13)	—			Ⓔ 595-A34 Ⓔ		—
13D	Overload Mounting Plate	—	—	—	40430-045-02	40440-028-02	42450-028-02
13E	Jumper	—	—	—	—	—	42195-800-01
14	Smart Motor Protection (SMP) Solid-state Overload Relay	See Table on page 5					
14A	SMP Reset Bar Only (SMP-1, SMP-2)	40794-011-01					
15	Mtg. Screw w/Washer (3 req'd)	28169-100-26		28169-101-26	40430-460-51	40440-459-51Ⓔ	
16	Mounting Plate for Eutectic Alloy, SMP-1™, SMP-2™ Ⓙ	40410-124-02		40420-083-02	40430-044-02	40440-027-02	
	Mounting Plate for SMP-3™ Ⓙ	40794-031-02		40794-032-02			
17	Current Transformer	—	—	—	—	—	X-241563Ⓔ
17A	Transformer Spring	—	—	—	—	—	42450-806-01Ⓔ

Parts indicated with Ⓔ are recommended spare parts.

Ⓐ This renewal parts list does not apply to Size 5 Series A construction. Refer to Publication 509-6.4.

Ⓑ Less contacts, order Single Pole Contact Sets as required.

Ⓒ Front and rear terminal assembly not available as a renewal part. Replace stationary contact block and base assembly

Ⓓ Front Terminal Screw Part No. 28168-503-26 and Rear Terminal Screw Part No. 28168-502-26.

Ⓔ For size 5 starter a current transformer assembly (which includes items 13, 15, 17, and 17A) can be ordered. Order Part No. 42452-800-01.

Ⓕ Auxiliary mounted on right-hand side of overload relay provides N.O. contact function. Auxiliary mounted on left-hand side provides N.C. contact function.

Ⓖ Size 0, 1, and 2 Eutectic alloy, SMP-1, and SMP-2 overload relays are attached directly to the mounting plate. Sizes 3, 4, and 5 eutectic alloy, SMP-1, and SMP-2 overload relays require a separate mounting plate. See Item 13D for sizes 3 and 4. Size 5 overload relay mounting plate is similar.

Renewal Parts

Bulletin 509, Sizes 0 through 4 (all series)
Size 5 (series L)

Operating Coils

AC Volts	Hz	Coil No.				
		Size 0-1	Size 2	Size 3	Size 4	Size 5 Series L 
24	60	CB013	CC013	CD013	—	—
115-120	60	CB236	CC236	CD236	CE236	AF236
110	50					AF236
110-115	50	CB322	CC322	CD322	CE322	AF322
200-208	60	CB249	CC249	CD249	CE249	AF249
220-230	50	CB339	CC339	CD339	CE339	AF339
230-240	60	CB254	CC254	CD254	CE254	AF254
	50	CB342	CC342	CD342	CE342	AF342
277	60	CB260	CC260	CD260	CE260	AF260
380	50	CB354	CC354	CD354	CE354	AF354
415	50	CB357	CC357	CD357	CE357	AF357
440-460	50	CB360	CC360	CD360	CE360	AF360
460-480	60	CB273	CC273	CD273	CE273	AF273
500	50	CB364	CC364	CD364	CE364	AF364
575-600	60	CB278	CC278	CD278	CE278	AF278

Parts indicated with  are recommended spare parts.

 For Size 5 Series A coils, refer to Publication 509-6.4.

Coil Data

Contactor or Starter Size	No. of Poles	Voltamperes Burden for 60 Hz Coils 											
		24 Volts		115- 120 Volts		200- 208 Volts		230- 240 Volts		460- 480 Volts		575- 600 Volts	
		Inrush	Sealed	Inrush	Sealed	Inrush	Sealed	Inrush	Sealed	Inrush	Sealed	Inrush	Sealed
0	2-5	192	29	192	29	192	29	192	29	192	29	192	29
1	2-5	192	29	192	29	192	29	192	29	192	29	192	29
2	2-3	240	29	240	29	240	29	240	29	240	29	240	29
2	4-5	315	38	315	38	315	38	315	38	315	38	315	38
3	2-3	660	45	660	45	660	45	660	45	660	45	660	45
3	4-5	840	58	840	58	840	58	840	58	840	58	840	88
4	2-3	—	—	1225	69	1225	69	1225	69	1225	69	1225	69
4	4-5	—	—	1490	96	1490	96	1490	96	1490	96	1490	96
5 (Series L)	2-3	—	—	1490	96	1490	96	1490	96	1490	96	1490	96

 For 50 Hz coils, consult your nearest Allen-Bradley Sales Office.