

SPD Series

Catalog Numbering System

Cross Reference RA Part Number PN-341262

Table 34.1-5. SPD Series Units Mounted Internal to Electrical Distribution Equipment (Integrated Units)

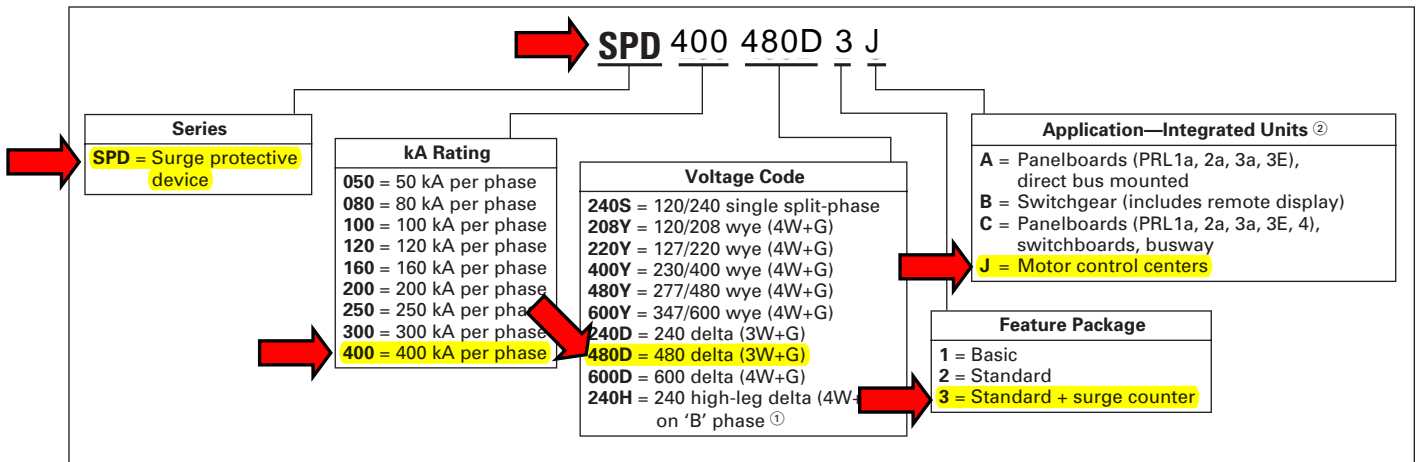

① Please consult the factory for 240 high-leg delta (4W+G) applications with high leg on 'C' phase.

② Units used in PRL1a, 2a, 3a and 3E panelboard applications are available in 50–200 kA ratings only. Use the 'C' option for PRL1a, 2a, 3a and 3E panelboard applications when unit is connected through a circuit breaker.
Example: SPD250480D2J = SPD Series, 250 kA per phase, 480D voltage, standard feature package, motor control center application.

Table 34.1-6. SPD Series Units for Mounting External to Electrical Distribution Equipment (Sidemount Units)

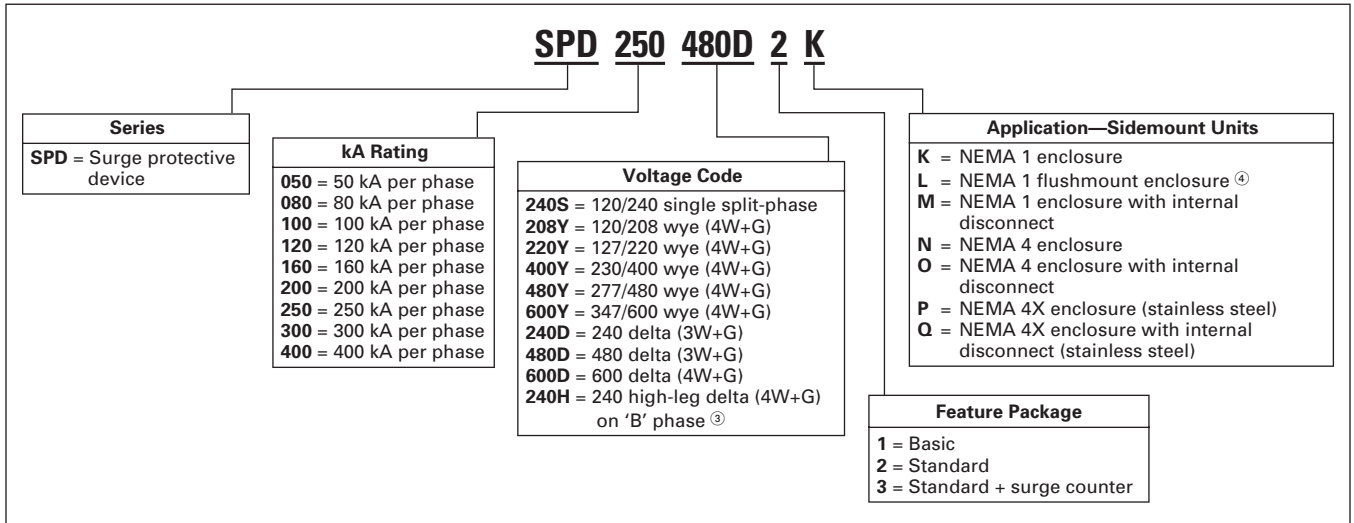

③ Please consult the factory for 240 high-leg delta (4W+G) applications with high leg on 'C' phase.

④ NEMA 1 flushmount units are available in 50–200 kA ratings only.
Example: SPD250480D2K = SPD Series, 250 kA per phase, 480D voltage, standard feature package, housed in NEMA 1 enclosure.