



**CROSS REFERENCE TO ROCKWELL  
PART NUMBER PP7403**

## Description and Operating Instructions ETHERNET Twisted Pair Industrial Hubs for ISO/DIN Rail

### RH1-TP

Order No.

**943 639-002**

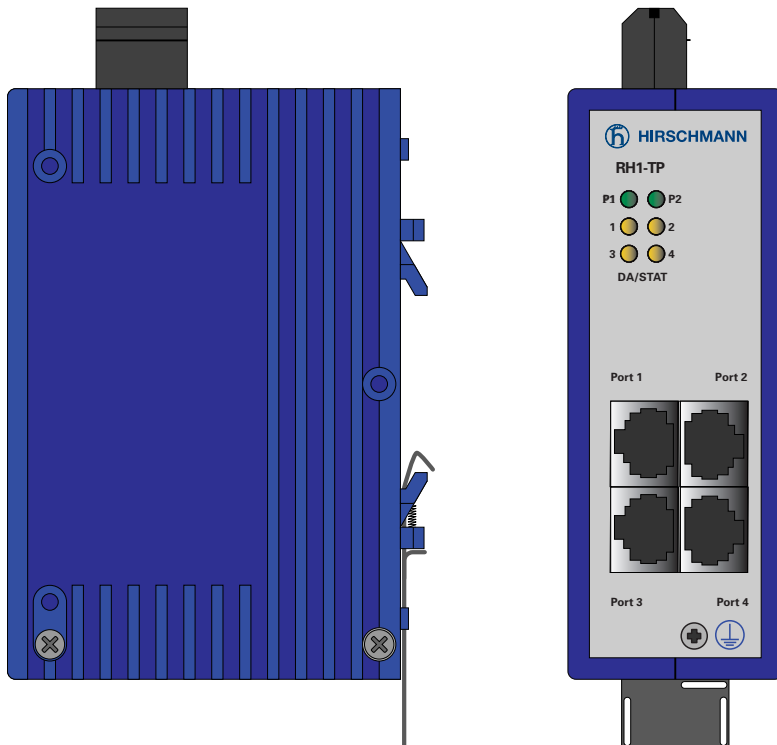

The rail hub RH1-TP supports a fast and reasonable network expansion. You can connect up to four data terminal equipments or further twisted pair segments via twisted pair.

For startup procedure just fit the rail hub on an ISO/DIN rail, without any further configuration time. The V.24 voltage is supplied via the terminal block and can be feed in redundantly.

The terminal block contains an integrated indicator contact, receiving error and warning messages of the rail hub which are defined as digital signals. These signals e.g. can be utilized as process messages by a programmable logic control (PLC). The indicator contact becomes active as soon as disturbances appear in the rail hubs, that is when a power supply should fail or at least one TP port reports a faulty link status or has auto partitioned.

For diagnosis there are LEDs available which indicate collisions, link status, segmentation, power and received data.

The railhub has four twisted pair (TP) interfaces. It is possible to connect up to four terminals or other TP segments using TPs.

The module conforms to the specifications of ISO/IEC standard 8802-3.

You will find a detailed description for construction of a local area network on network planning and installation in the "Ethernet manual" (Order no. 943 320-011).

The performance features described here are binding only if they have been expressly guaranteed in the contract. We have checked that the contents of the technical publication agree with the hardware and software described. However, it is not possible to rule out deviations completely, so we are unable to guarantee complete agreement. However, the details in the technical publication are checked regularly. Any corrections which prove necessary are contained in subsequent editions. We are grateful for suggestions for improvement.

We reserve the right to make technical modifications.

Permission is not given for the circulation or reproduction of this document, its use or the passing on of its contents unless granted expressly. Contravention renders the perpetrator liable for compensation for damages. All rights reserved, in particular in the case of patent grant or registration of a utility or design.

Copyright  
© Hirschmann Electronics GmbH 2005  
All Rights Reserved

## Note

We would point out that the content of these operating instructions is not part of, nor is it intended to amend an earlier or existing agreement, permit or legal relationship. All obligations on Hirschmann arise from the respective purchasing agreement which also contains the full warranty conditions which have sole applicability. These contractual warranty conditions are neither extended nor restricted by comments in these operating instructions.

We would furthermore point out that for reasons of simplicity, these operating instructions cannot describe every conceivable problem associated with the use of this equipment. Should you require further information or should particular problems occur which are not treated in sufficient detail in the operating instructions, you can request the necessary information from your local Hirschmann sales partner or directly from the Hirschmann office (address: refer to chapter entitled „Notes on CE identification“).

## Safety Instructions

This manual contains instructions which must be observed to ensure your own personal safety and to avoid damage to devices and machinery. The instructions are highlighted with a warning triangle and are shown as follows according to the degree of endangerment:



### Danger!

means that death, serious injury or considerable damage to property **will** result if the appropriate safety measures are not taken.



### Warning!

means that death, serious injury or considerable damage to property **can** result if the appropriate safety measures are not taken.



### Caution!

means that light injury or damage to property can result if the appropriate safety measures are not taken.

**Note:** is an important piece of information about the product, how to use the product, or the relevant section of the documentation to which particular attention is to be drawn.

## Certified usage

Please observe the following:



### Warning

The device may only be employed for the purposes described in the catalog and technical description, and only in conjunction with external devices and components recommended or approved by Hirschmann. The product can only be operated correctly and safely if it is transported, stored, installed and assembled properly and correctly. Furthermore, it must be operated and serviced carefully.

## Safety Guidelines Power Supply

Switch the basic devices on only when the case is closed.



### Warning!

The devices may only be connected to the supply voltage shown on the type plate.

The devices are designed for operation with a safety extra-low voltage. Thus, they may only be connected to the supply voltage connections and to the signal contact with PELV circuits or alternatively SELV circuits with the voltage restrictions in accordance with IEC/EN 60950.

For the case where the module is operated with external power supply: Use only a safety extra-low voltage in accordance with IEC 950/EN 60 950/VDE 0805 to power the system.

First of all you connect the protecting line, before you establish the further connections. When you remove connections, you disconnect the protecting line last.

Relevant for North America:

The subject unit is to be supplied by a Class 2 power source complying with the requirements of the National Electrical Code, table 11(b). If power is redundant supplied (two individual power sources) the power sources together should comply with the requirements of the National Electrical Code, table 11 (b).

Relevant for North America:

Power, input and output (I/O) wiring must be in accordance with Class I, Division 2 wiring methods [Article 501-4(b) of the National Electrical Code, NFPA 70] and in accordance with the authority having jurisdiction.

Peripheral equipment must be suitable for the location it is used in.

For use in Class 2 circuits.

Use 60/75°C or 75°C copper(CU)wire only.

## Safety Guidelines Shielding Ground

**Note:** The shielding ground of the connectable twisted pairs lines is connected to the front panel as a conductor.

Beware of possible short circuits when connecting a cable section with conductive shielding braiding.

## Safety Guidelines Housing



### Warning!

Only technicians authorized by Hirschmann are permitted to open the housing.

**Note:** The device is grounded via the separated ground screw. It is located on the left under the front panel.

Make sure that the electrical installation meets local or nationally applicable safety regulations.



### Warning!

The ventilation slits must not be covered so as to ensure free air circulation.

The distance to the ventilation slots of the housing has to be a minimum of 10 cm.

Never insert pointed objects (thin screwdrivers, wires, etc.) into the inside of the subrack! This especially applies to the area behind the socket connectors. Failure to observe this point may result in injuries caused by electric shocks.

**Note:** According to EN 60950 the device may only be operated in a fire protective housing.

**Note:** The housing has to be mounted in upright position.

## Safety Guidelines Environment



### Warning!

The device may only be operated in the listed ambient temperature range at the listed relative air humidity (non-condensing).

- The installation location is to be selected so as to ensure compliance with the climatic limits listed in the Technical Data.
- To be used in an up to Pollution Degree 2 environment only (IEC 60664-1).

## Staff qualification requirements

**Note:** Qualified personnel, as understood in this manual and in the warning signs, are persons who are familiar with the setup, assembly, startup, and operation of this product and are appropriately qualified for their job. This includes, for example, those persons who have been:

- trained or directed or authorized to switch on and off, to ground and to label power circuits and devices or systems in accordance with current safety engineering standards
- trained or directed in the care and use of appropriate safety equipment in accordance with the current standards of safety engineering
- trained in providing first aid.

## General Safety Instructions

- This device is electrically operated. Adhere strictly to the safety requirements relating to voltages applied to the device as described in the operating instructions!



### Warning!

Failure to observe the information given in the warnings could result in serious injury and/or major damage.

Only personnel that have received appropriate training should operate this device or work in its immediate vicinity. The personnel must be fully familiar with all of the warnings and maintenance measures in these operating instructions.

Correct transport, storage, and assembly as well as careful operation and maintenance are essential in ensuring safe and reliable operation of this device.

Use only undamaged parts!

- These products are only to be used in the manner indicated in this version of the "Description and Operating Instructions".
- Particular attention is to be paid to all warnings and items of information relating to safety.



### Warning!

Any work that may have to be performed on the electrical installation should be performed by fully qualified technicians only.

## Based specifications and standards:

The devices fulfil the following specifications and standards:

- EN 61000-6-2:1999 Generic standards – Immunity for industrial environments
- EN 55022:1998 – Information technology equipment – Radio disturbance characteristics
- EN 60950:1997 – Safety of Information Technology Equipment (ITE)
- EN 61131-2:1994 – Programmable Controllers
- CFR-47 Part 15:1997 – Code of Federal Regulations
- Germanischer Lloyd Part 1:1997 – Test Requirements for Electronic Equipment
- UL 508:1998 – Underwriters Laboratories Inc. Standard for Safety

## CE Notes on CE identification

The devices comply with the regulations of the following European directive:

89/336/EEC

Council Directive on the harmonization of the legal regulations of member states on electromagnetic compatibility (amended by Directives 91/263/EEC, 92/31/EEC and 93/68/EEC).

The EU declaration of conformity is kept available for the responsible authorities in accordance with the above-mentioned EU directives at:

Hirschmann Electronics GmbH  
Automation and Network Solutions  
Stuttgarter Straße 45-51  
D-72654 Neckartenzlingen  
Telephone ++49-1805-14-1538

The product can be used in the residential sphere (residential sphere, business and trade sphere and small companies) and in the industrial sphere.

- Interference immunity:  
EN 61000-6-2:2001
- Radio interference level:  
EN 55022:1998 + A1 2000  
+ A2 2003, Class A



### Warning!

This is a Class A device. This equipment may cause radio interference if used in a residential area; in this case it is the operator's responsibility to take appropriate measures.

The precondition for compliance with EMC limit values is strict adherence to the construction guidelines specified in this description and operating instructions.

## FCC Note:

This equipment has been tested and found to comply with the limits for a Class A digital device, pursuant to part 15 of the FCC Rules. These limits are designed to provide reasonable protection against harmful interference when the equipment is operated in a commercial environment. This equipment generates, uses, and can radiate radio frequency energy and, if not installed and used in accordance with the instruction manual, may cause harmful interference to radio communications. Operation of this equipment in a residential area is likely to cause harmful interference in which case the user will be required to correct the interference at his own expense.



## Recycling Note:

After its use, this product has to be processed as electronic scrap and disposed of according to the prevailing waste disposal regulations of your community/district/country/state.

# 1. Functional description

## 1.1 GENERAL FUNCTIONS

### Signal regeneration

The RH1-TP processes the signal shape and amplitude of the data received.

### Retiming

In order to prevent jitter increasing over several segments, the RH1-TP retimes the data to be transmitted.

### Preamble regeneration

The RH1-TP supplements lost preamble bits from data received to 64 bits (incl. the start of frame delimiter (SFD)).

### Fragment extension

Collisions can cause short fragments to occur. If the RH1-TP receives a fragment, this is supplemented to give the minimum length of 96 bits. This ensures reliable collision detection by all network participants.

### Collision handling

If the RH1-TP detects a data collision, it interrupts the transmission. For the duration of the collision, the collided data package is replaced by a jam signal to ensure collision detection by the terminal equipments.

### Auto partitioning

Network failures can be caused by permanent occupancy, interrupted lines, lack of terminating resistors, damaged cable insulation and frequent collisions due to electromagnetic interference. In order to protect the network from such failures, the RH1-TP in this case separates the segment in the receiving direction from the rest of the network.

The RH1-TP has this auto partitioning function individually at each port. The other ports can thus continue to be operated without interference if one of the ports has been auto partitioned. In the event of auto partitioning, transmission continues into the TP segment but reception at this port is blocked.

With twisted pair, auto partitioning is activated if

- a data collision lasts longer than 105 µs or
- there are more than 64 consecutive data collisions.

### Reconnection

The segment is reconnected to the network as soon as a package with the minimum length of 51 µs is received without collision at the relevant port, i. e. when the segment is working properly again.

### Jabber control

Due to a defective transceiver or LAN controller, for example, the network can be continuously occupied with data. To protect against this, the RH1-TP interrupts reception at the affected TP port after 5.5 ms for a duration of 9.6 µs. This cycle (transmission for 5,5 ms, interruption for 9,6 µs) is repeated until the end of the error (jabber lockup protection).

## 1.2 SPECIFIC FUNCTIONS OF THE TP INTERFACE

### Link control

The RH1-TP monitors the connected TP line segments for short-circuit or interrupt using idle signals during frame pauses in accordance with IEEE standard 802.3 10BASE-T. The RH1-TP does not transmit any data in a TP segment from which it does not receive an idle signals.

**Note:** A non-occupied interface is assessed as a line interrupt. The TP line to terminal equipment which is switched off is likewise assessed as a line interrupt as the de-energised transceiver cannot transmit idle signals.

### Auto polarity exchange

If the reception line pair is incorrectly connected (RD+ and RD- switched) polarity is automatically reversed.

## 1.3 DISPLAY ELEMENTS

### Equipment status

The two LEDs provide information about the status which affects the function of the entire RH1-TP.

#### P1 – Power 1 (green LED)

- lit: supply voltage 1 present
- lit not: - supply voltage 1 not present, - hardware fault in RH1-TP

#### P2 – Power 2 (green LED)

- lit: supply voltage 2 present
- lit not: - supply voltage 2 not present, - hardware fault in RH1-TP

### Port Status

These groups of LEDs display port-related information.

#### DA/STAT 1 to DA/STAT 4 - link status of the TP ports (4 x green/yellow LED)

- lit yellow: RH1-TP receiving data
- lit green: RH1-TP receiving link test pulses from TP segment, - the TP segment connected is working properly
- flashes green: port has auto partitioned
- lit not: RH1-TP is not receiving any idle signals from TP segment, - the assigned TP port is not connected, - the equipment connected is switched off, - the TP line is interrupted or short-circuited

## 1.4 CONTROLS

### 6-pin DIP switch

Using the 6-pin DIP switch on the top of the RH1-TP housing

- the message about the link statuses can be suppressed by the indicator contact on a port-by-port basis. Using switches LA1 to LA4, the message about the link status of ports 1 to 4 is suppressed. State on delivery: switch position 1 (ON), i.e. message not suppressed.

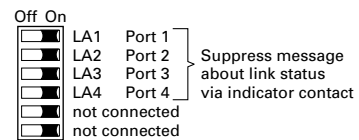

Fig. 1: 6-pin DIP switch

## 1.5 INTERFACES

### TP connection

Four 8pole RJ45 sockets enable four independent TP segments to be connected.

- **Pin configuration** of the RJ45 socket:

- TD+: Pin 3, TD-: Pin 6
- RD+: Pin 1, RD-: Pin 2
- remaining pins: not configured.

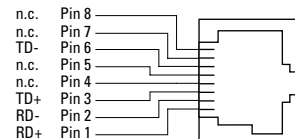

Fig. 2: Pin configuration TP interface

### 5-pin terminal block

The supply voltage and the indicator contact are connected via a 5-pin terminal block with screw locking mechanism.



### Warning!

The RH1-TP equipments are designed for operation with a safety extra-low voltage. Thus, they may only be connected to the supply voltage connections and to the signal contact with PELV circuits or alternatively SELV circuits with the voltage restrictions in accordance with IEC/EN 60950.

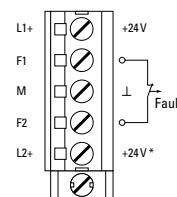

Fig. 3: Pin configuration of 5-pin terminal block

- **Voltage supply:** The voltage supply can be connected to be redundant. Both inputs are decoupled. There is no load distribution. With redundant supply, the power pack supplies the RH1-TP alone with the higher output voltage. The supply voltage is electrically isolated from the housing.

- **Indicator contact:** Contact interrupt indicates the following by means of a potential-free indicator contact (relay contact, closed circuit):
  - the failure of at least one of the two supply voltages.
  - a permanent fault in the hub for ISO/DIN rail (internal 5 V DC voltage, supply voltage 1 or 2 not in the permissible range).

- the faulty link status of at least one TP port.
- The indication of the link state might be masked on a port-by-port basis using DIP switches.
- at least one port has auto partitioned.

**Note:** In the case of the voltage supply being routed without redundancy, the RH1-TP indicates the failure of a supply voltage. You can prevent this message by feeding in the supply voltage through both inputs.

## 2. Configuration

### 2.1 STAND ALONE STRUCTURE STAR SHAPED STRUCTURE

The RH1-TP enables connection of up to four data terminal equipments or further twisted pair segments via twisted pair.

### 2.2 EXPANSION OF EXISTING NETWORKS

The rail hub RH1-TP gives you the possibility to expand your network in a fast and reasonable way, for example an existing rail hub-/rail switch link.

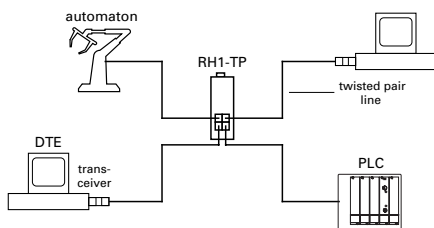

Fig. 4: Stand-alone configuration of the RH1-TP

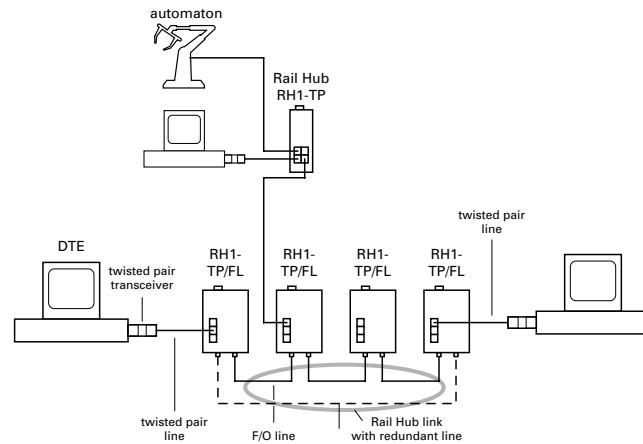

Fig. 5: Expansion of a rail hub link

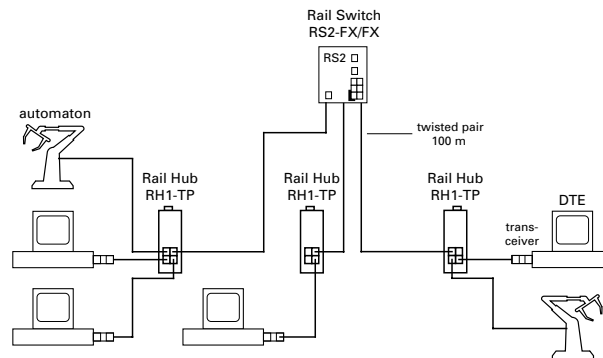

Fig. 6: Configuration with rail switch

## 3. Assembly, startup procedure and dismantling

### 3.1 UNPACKING, CHECKING

- Check whether the package was delivered complete (see scope of delivery).
- Check the individual parts for transport damage.

**Warning!**  
Use only undamaged parts!

### 3.2 ASSEMBLY

The equipment is delivered in a ready-to-operate condition. The following procedure is appropriate for assembly:

- Check whether the switch pre-setting suits your requirements.
- Pull the terminal block off the RH1-TP and wire up the supply voltage and indicator lines.
- Fit the RH1-TP on a 35 mm ISO/DIN rail to DIN EN 50 022.
- Suspend the upper snap-in hook of the RH1-TP in the ISO/DIN rail, insert a screwdriver horizontally under the housing into the locking slide pull this downwards (cf. Fig. 8, dismantling) and press the bottom of the module onto the ISO/DIN rail until it locks in position (Fig. 7).
- Fit the signal lines.

### Notes:

- The front panel of the RH1-TP is grounded via the separate ground connection in the front panel.
- The screws in the lateral half-shells of the housing may not be undone under any circumstances.
- The shielding ground of the twisted pair lines which can be connected is electrically connected to the housing.

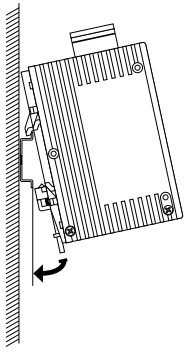

Fig. 7: Assembling the RH1-TP

### 3.3 STARTUP PROCEDURE

You start up the RH1-TP by connecting the supply voltage via the 5-pin terminal block. Lock the terminal block with the locking screw at the side.

### 3.4 DISMANTLING

To take the RH1-TP off the ISO/DIN rail, insert a screwdriver horizontally under the housing into the locking slide, pull it (without tipping the screwdriver) downwards and fold the RH1-TP upwards.

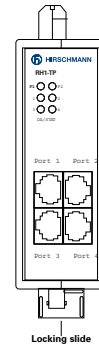

Fig. 8: Dismantling the RH1-TP

## 4. Further support

In the event of technical queries, please talk to the Hirschmann contract partner responsible for looking after your account or directly to the Hirschmann office. You can find the addresses of our contract partners – on the Internet (<http://www.hirschmann.de>).

Our support line is also at your disposal:  
 Tel. +49(1805) 14-1538  
 Fax +49(7127) 14-1551

Answers to Frequently Asked Questions can be found on the Hirschmann internet site [www.hirschmann.de](http://www.hirschmann.de)

The FAQs are located under „Service“ in the Automation and Network Solutions section.

[www.hicomcenter.com](http://www.hicomcenter.com) gives you an up-to-date overview of training courses about technology and products.

## 5. Technical data

### General data

Operating voltage	NEC Class 2 power source 24 VDC (-25% +33%) safety extra-low voltage (SELV/PELV) (redundant inputs decoupled), 5 A maximum	
Buffer time	min. 10 ms at 24 VDC	
Potential difference between input voltage and housing	Potential difference to input voltage, +24 VDC: 32 VDC Potential difference to input voltage, ground: -32 VDC	
Current consumption at 24 VDC	3.2 W maximum; 11 Btu (IT)/h	
Overload current protection at input	non-changeable thermal fuse	
Dimensions W x H x D	40 mm x 125 mm x 80 mm	(1.57 in x 4.92 in x 3.15 in)
Mass	530 g	(1.167 lb)
Ambient temperature	Surrounding air: 0 °C to + 60 °C	(32 °F to + 140 °F)
Storage temperature	Surrounding air: - 40 °C to + 80 °C	(-40 °F to + 176 °F)
Humidity	10% to 95% (non condensing)	
Atmospheric pressure	Suitable for operation up to 2000 m (6561 ft), 795 hPa, higher altitudes on demand)	
Protection type	IP 30	
Interference proof		
Discharge of static electricity		
Contact discharge	EN 61000-4-2 Test level 3	
Air discharge	EN 61000-4-2 Test level 3	
Electromagnetic fields	EN 61000-4-3 Test level 3	
Fast transients	EN 61000-4-4 Test level 3	
Surge voltage symmetrical	EN 61000-4-5 Test level 2	
Surge voltage asymmetrical	EN 61000-4-5 Test level 3	
Cable-based RF faults	EN 61000-4-6 Test level 3	
EMC emitted immunity		
EN 55022	Class A	
FCC 47 CFR Part 15	Class A	
Stability		
Vibration	IEC 60068-2-6 Test FC, testing level in line with IEC 61131-2	
Shock	IEC 60068-2-27 Test Ea, testing level in line with IEC 61131-2	
Interfaces	4 ports in compliance to 10BASE-T with RJ45 connectors (shielded) 1 x 5 pole mountable terminal block	
Displays	P1, P2: power DA/STAT 1 to DA/STAT 4: data, collision, link status per port, segmentation	

### Network size

<b>Transition</b>	TP-Port ↔ TP-Port	
Propagation equivalent	190 m	(624 ft)
Variability value	4 BT	
<b>TP line length (TP-Port ↔ TP-Port)</b>		
Length of a twisted pair segment	max. 100 m	(328 ft)

### Scope of delivery

RH1-TP Twisted Pair Industrial Hub for ISO/DIN Rail incl. terminal block for supply voltage description and operating instructions		
Order number		
RH1-TP – Twisted Pair Industrial Hub for ISO/DIN Rail	943 639-002	

### Accessories

Ethernet manual	943 320-011	
Manual		
Basics Industrial ETHERNET and TCP/IP	280 720-834	
Rail Power Supply RPS 30	943 662-003	
Rail Power Supply RPS 60	943 662-001	
Rail Power Supply RPS 120	943 662-011	

Hirschmann Electronics GmbH  
Automation and Network Solutions  
Stuttgarter Straße 45-51  
D-72654 Neckartenzlingen  
Germany  
Tel.: ++49 / 1805 / 14-1538  
Fax: ++49 / 7127 / 14-1551  
E-Mail: [ans-support@hirschmann.de](mailto:ans-support@hirschmann.de)  
Internet: <http://www.hirschmann.com>

Printed in Germany  
Subject to alterations



039597002070305000