

1606-XLS80E 24V, 3.4A; Single Phase Input

1606-XLS80E

24V,3.4A Single Phase Input

POWER SUPPLY

- Ultra-small size
- Extra-low inrush current
- Active power factor correction
- Wide range AC/DC input
- Superior reserve power (can support 150% rated power for five seconds)
- Superior efficiency and temperature rating
- DC-OK and overload LED



1. GENERAL DESCRIPTION

The most outstanding features of this 1606-XLS DIN-rail power supply are the high efficiency and the small size, which are achieved by a synchronous rectification and further novel design details.

With short-term peak power capability of 150% and built-in large sized output capacitors, these features help start motors, charge capacitors and absorb reverse energy and often allow a unit of a lower wattage class to be used.

High immunity to transients and power surges as well as low electromagnetic emission makes usage in nearly every environment possible.







The integrated output power manager, a wide range input voltage design and virtually no input inrush current make installation and usage simple. Diagnostics are easy due to the dry DC-ok contact, a green DC-ok LED and red overload LED.

Unique quick-connect spring-clamp terminals allow a safe and fast installation and a large international approval package for a variety of applications makes this unit suitable for nearly every situation.

2. SPECIFICATION QUICK REFERENCE

Output voltage	DC 24V	
Adjustment range	24-28V	
Output current	3.4A	continuous, 24V
	5A	for typ. 4s, 24V
Output power	80W	continuous, 24V
	120W	for typ. 4s, 24V
Output ripple	< 50mVpp	20Hz to 20MHz
Input voltage	AC 100-240V	±15%
Line frequency	50-60Hz	±6%
AC Input current	1.42 / 0.82A	at 120 / 230Vac
Power factor	0.53 / 0.47	at 120 / 230Vac
AC Inrush current	typ. 5 / 10A peak	at 120 / 230Vac
DC Input voltage	DC 110-300V	-20%/+25%
DC Input current	0.8 / 0.29A	at 110 / 300Vdc
Efficiency	88.7 / 90.0%	at 120 / 230Vac
Losses	10.4 / 9.1W	at 120 / 230Vac
Temperature range	-25°C to +70°C	operational
Derating	2W/°C	+60 to +70°C
Hold-up time	typ. 41 / 174ms	at 120 / 230Vac
Dimensions	32x124x102mm	WxHxD

3. AGENCY APPROVALS

 UL US LISTED IND. CONT. EQ. UL 508	 UL 60950-1
 Class I Div 2	
 EMC, LVD	

4. RELATED PRODUCTS

1606-XLB	Wall mount bracket
1606-XLSRED	Redundancy Module
1606-XLBUFFER	Buffer unit



1606-XLS80E 24V, 3.4A; Single Phase Input

INDEX	PAGE	INDEX	PAGE
1. General Description	1	21. Fulfilled Standards	13
2. Specification Quick reference	1	22. Used Substances	13
3. Agency Approvals	1	23. Physical Dimensions and Weight	14
4. Related Products	1	24. Installation and Operation Instructions	14
5. AC-Input	3	25. Accessories	15
6. Input Inrush Current	4	26. Application Notes	16
7. DC-Input	4	26.1. Repetitive Pulse Loading	16
8. Output	5	26.2. Peak Current Capability	17
9. Hold-up Time	7	26.3. Back-feeding Loads	17
10. Efficiency and Power Losses	7	26.4. Charging of Batteries	17
11. Functional Diagram	8	26.5. Output Circuit Breakers	18
12. Product Face label	8	26.6. External Input Protection	18
13. Terminals and Wiring	9	26.7. Parallel Use to Increase Output Power	19
14. Reliability	9	26.8. Parallel Use for Redundancy	19
15. EMC	10	26.9. Daisy Chaining of Outputs	19
16. Environment	11	26.10. Series Operation	20
17. Protection Features	12	26.11. Inductive and Capacitive Loads	20
18. Safety	12	26.12. Operation on Two Phases	20
19. Dielectric Strength	12	26.13. Use in a Tightly Sealed Enclosure	20
20. Approvals	13	26.14. Mounting Orientations	21

INTENDED USE

Those responsible for the application and use of the products must satisfy themselves that all necessary steps have been taken to assure that each application and use meets all performance and safety requirements, including and applicable laws, regulation , codes, and standards.

TERMINOLOGY AND ABBREVIATIONS

PE and  symbol	PE is the abbreviation for Protective Earth and has the same meaning as the symbol  .
Earth, Ground	This document uses the term “earth” which is the same as the U.S. term “ground”.
T.b.d.	To be defined, value or description will follow later.
AC 230V	A figure displayed with the AC or DC before the value represents a nominal voltage with standard tolerances (usually ±20%) included. E.g.: DC 12V describes a 12V battery disregarding whether it is full (13.7V) or flat (10V) As long as not otherwise stated, AC 100V and AC 230V parameters are valid at 50Hz and AC 120V parameters are valid at 60Hz mains frequency.
230Vac	A figure with the unit (Vac) at the end is a value without any additional tolerances included.
PELV	Protective Extra Low Voltage
SELV	Safety Extra Low Voltage

DISCLAIMER

The information presented in this document is believed to be accurate and reliable and may change without notice.

1606-XLS80E 24V, 3.4A; Single Phase Input

5. AC-INPUT

AC input	nom.	AC 100-240V	see Fig. 5-1
AC input range	min.	85-276Vac	continuous operation
	min.	60-85Vac	full power for 200ms, no damage between 0 and 85Vac
	min.	276-300Vac	< 500ms
Input frequency	nom.	50 – 60Hz	±6%
Turn-on voltage	typ.	61Vac	steady-state value, see Fig. 5-1
Shut-down voltage	typ.	58Vac	steady-state value, see Fig. 5-1

		AC 100V	AC 120V	AC 230V	
Input current	typ.	1.67A	1.42A	0.82A	at 24V, 3.4A, see Fig. 5-3
Power factor *	typ.	0.55	0.53	0.47	at 24V, 3.4A, see Fig. 5-4
Crest factor **	typ.	3.33	3.9	3.88	at 24V, 3.4A
Start-up delay	typ.	355ms	350ms	330ms	see Fig. 5-2
Rise time	typ.	6ms	5ms	7ms	0mF, 24V, 3.4A, see Fig. 5-2
	typ.	20ms	20ms	22ms	3.4mF, 24V, 3.4A, see Fig. 5-2
Turn-on overshoot	max.	50mV	50mV	50mV	See Fig. 5-2

* The power factor is the ratio of the true (or real) power to the apparent power in an AC circuit.

** The crest factor is the mathematical ratio of the peak value to RMS value of the input current waveform.

Fig. 5-1 Input voltage range

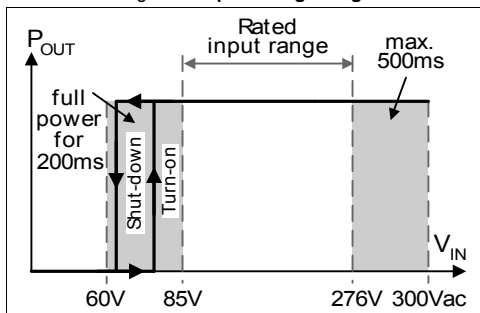

Fig. 5-2 Turn-on behavior, definitions

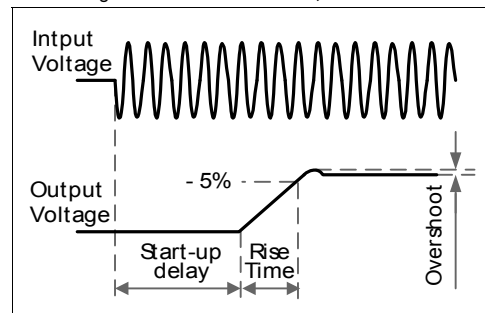

Fig. 5-3 Input current vs. output load at 24V

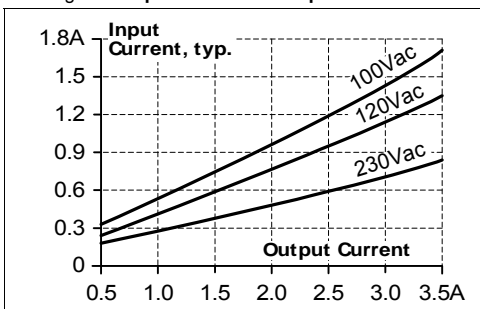
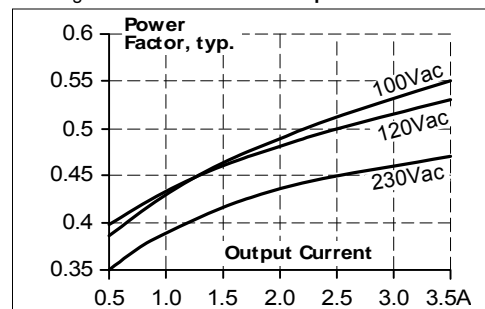

Fig. 5-4 Power factor vs. output load at 24V



1606-XLS80E 24V, 3.4A; Single Phase Input

6. INPUT INRUSH CURRENT

An active inrush limitation circuitry limits the input inrush current after turn-on of the input voltage and after short input voltage interruptions.

The charging current into EMI suppression capacitors is disregarded in the first milliseconds after switch-on.

		AC 100V	AC 120V	AC 230V	
Inrush current	max.	6A _{peak}	7A _{peak}	13A _{peak}	-25°C to +70°C
	typ.	4.5A _{peak}	5A _{peak}	10A _{peak}	-25°C to +70°C
Inrush energy	max.	2A ² s	2A ² s	2A ² s	-25°C to +70°C

Fig. 6-1 Input inrush current, typical behavior

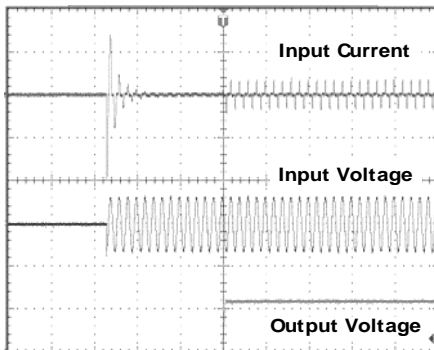

Input: 230Vac
 Output: 24V, 3.4A
 Ambient: 25°C
 Upper curve: Input current 5A / DIV
 Medium curve: Input voltage 500V / DIV
 Lower curve: Output voltage 20V / DIV
 Time basis: 100ms / DIV

7. DC-INPUT

DC input	nom.	DC 110-300V	
DC input range	min.	88-375Vdc	continuous operation
DC input current	typ.	0.8A / 0.29A	110Vdc / 300Vdc, 24V, 3.4A
Turn-on voltage	typ.	61Vdc	steady state value
Shut-down voltage	typ.	47Vdc	steady state value

Fig. 7-1 Wiring for DC Input

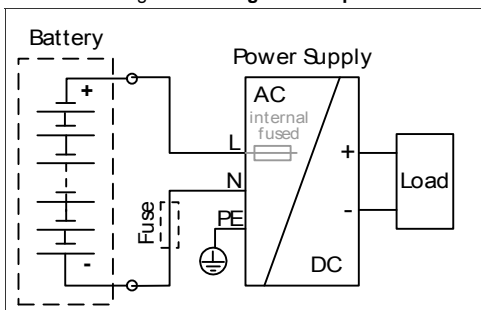

Instructions for DC use:

- Use a battery or similar DC source.
- Connect +pole to L and -pole to N.
- Connect the PE terminal to a earth wire or to the machine ground.

When the -pole of the battery is not connected to earth, use an appropriate fuse to protect the N terminal.

1606-XLS80E 24V, 3.4A; Single Phase Input

8. OUTPUT

Output voltage	nom.	24V	
Adjustment range	min.	24-28V	guaranteed, multi turn potentiometer
	max.	30V	at clockwise end position of potentiometer
Factory setting		24.1V	±0.2%, at full load, cold unit
Line regulation	max.	10mV	60 to 300Vac
Load regulation	max.	100mV	static value, 0A → 3.4A → 0A
Ripple and noise voltage	max.	50mVpp	20Hz to 20MHz, 50Ohm
Output capacitance	typ.	1 500µF	

Continuous power capability

Output current	nom.	3.4A	at 24V, see Fig. 8-1
	nom.	3.0A	at 28V, see Fig. 8-1
Output power	nom.	80W	24V, continuous
	nom.	84W	28V, continuous
Short-circuit current	min.	3.5A	load impedance 250mOhm, see Fig. 8-1
	max.	4.2A	load impedance 250mOhm, see Fig. 8-1

Power-Boost , short term power capability (up to typ. 4s)

The power supply is designed to support loads with a higher short-term power requirement without damage or shutdown. The short-term duration is hardware controlled by an output power manager. The **Power-Boost** is repeatedly available. Detailed information can be found in chapter 26.1 .

Once **Power-Boost** has been stopped by the output power limiter, a timer disables the next **Power-Boost** capability. The recovery timer will start as soon as the output voltage reaches the adjusted value again, which usually happens after the load has been reduced.

Output current	nom.	5A	at 24V, see Fig. 8-1
	nom.	4.5A	at 28V, see Fig. 8-1
Output power	nom.	120W	24V, short term
	nom.	126W	28V, short term
Short-circuit current	min.	5.2A	load impedance 250mOhm, see Fig. 8-1
	max.	6.0A	load impedance 250mOhm, see Fig. 8-1
Power-Boost time	typ.	4s	at 24V, 5A, duration until the output voltage dips, see Fig. 8-2
	min.	3s	
	max.	5s	
Power-Boost recovery time	typ.	7s	overload free time to reset power manager, see Fig. 8-3

Peak current capability (up to several ms)

The power supply can deliver a peak current which is higher than the specified short term current. This helps to start current demanding loads or to safely operate subsequent circuit breakers.

The extra current is supplied by the output capacitors inside the power supply. During this event, the capacitors will be discharged and causes a voltage dip on the output. Detailed curves can be found in chapter 26.1.

Peak current voltage dips	typ.	from 24V to 20V	at 6.8A for 10ms
	typ.	from 24V to 12.5V	at 13.5A for 2ms
	typ.	from 24V to 7.5V	at 13.5A for 5ms

1606-XLS80E 24V, 3.4A; Single Phase Input

Fig. 8-1 Output voltage vs. output current, typ.

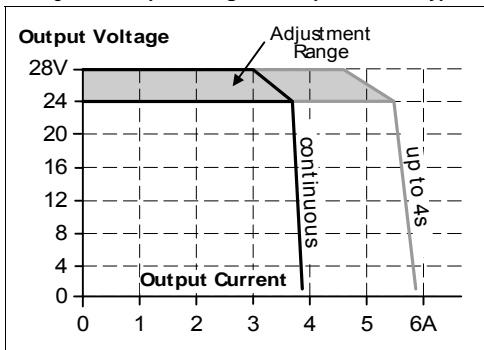

Fig. 8-2 Power-Boost time vs. output power

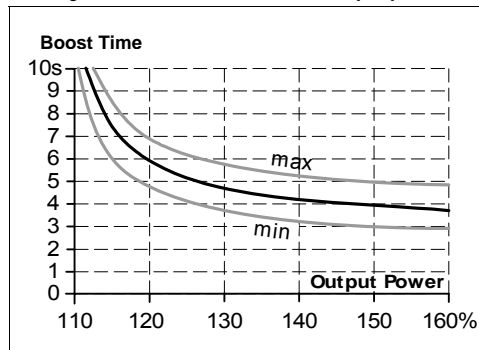
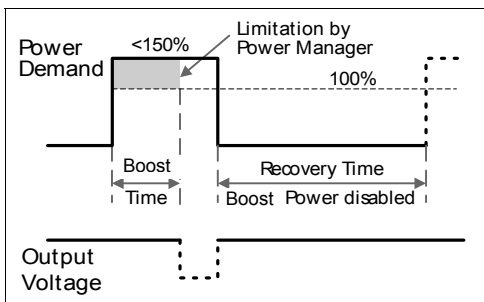

Fig. 8-3 Power-Boost recovery time



Power-Boost is available as soon as power comes on and immediately after the end of an output short circuit.

Fig. 8-4 Power-Boost after input turn-on

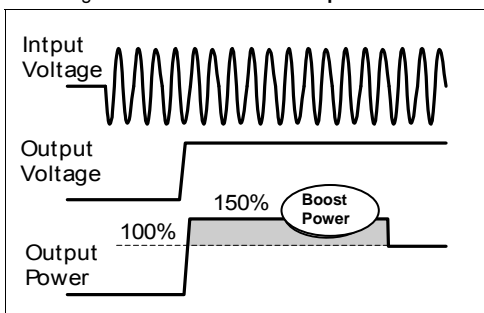
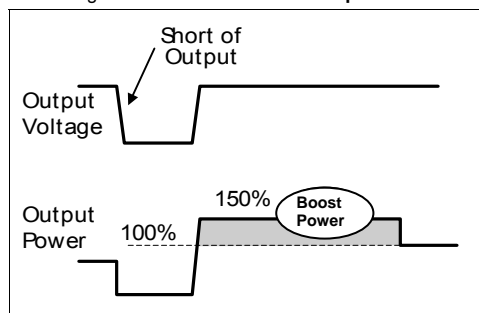

Fig. 8-5 Power-Boost after output short



1606-XLS80E 24V, 3.4A; Single Phase Input

9. HOLD-UP TIME

		AC 100V	AC 120V	AC 230V	
Hold-up Time	typ.	28ms	41ms	174ms	3.4A, 24V, see Fig. 9-1
	typ.	58ms	88ms	347ms	1.7A, 24V, see Fig. 9-1

Fig. 9-1 Hold-up time vs. input voltage

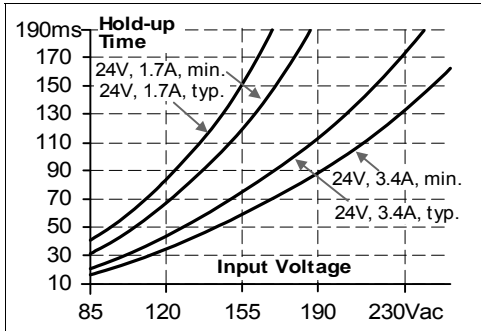
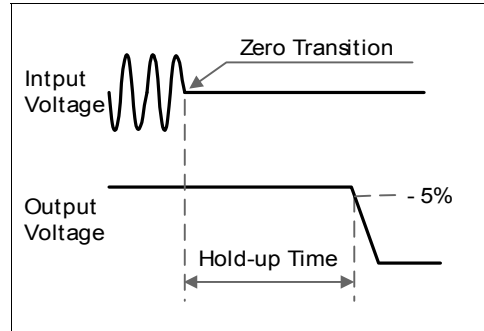

Fig. 9-2 Shut-down behavior, definitions



Note: At no load, the hold-up time can be up to one minute. The green DC-ok lamp is on during this time.

10. EFFICIENCY AND POWER LOSSES

		AC 100V	AC 120V	AC 230V	
Efficiency	typ.	91.2%	92.3%	93.0%	10A, 24V
Power losses	typ.	23.1W	20.0W	18.1W	10A, 24V
	typ.	5.6W	5.7W	5.9W	0A

Fig. 10-1 Efficiency vs. output current at 24V

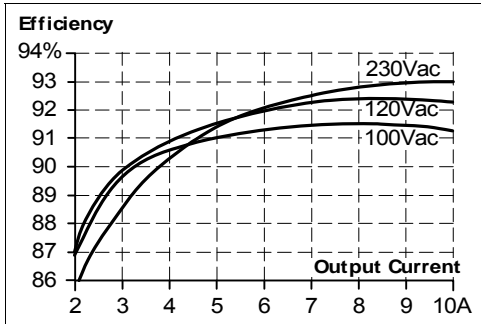

Fig. 10-2 Losses vs. output current at 24V

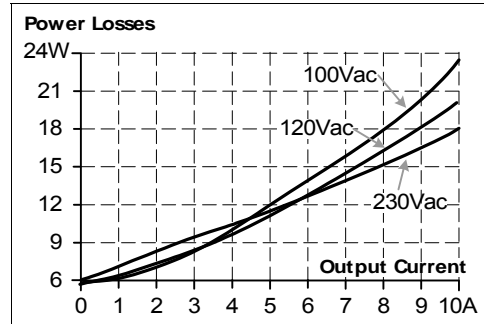

Fig. 10-3 Efficiency vs. input voltage, 24V, 10A

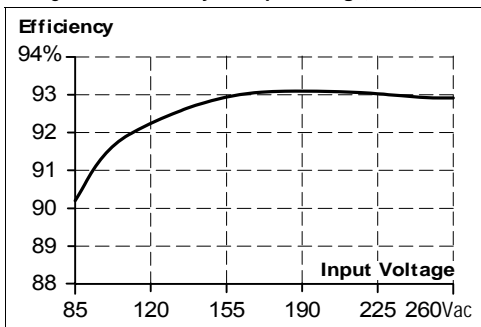
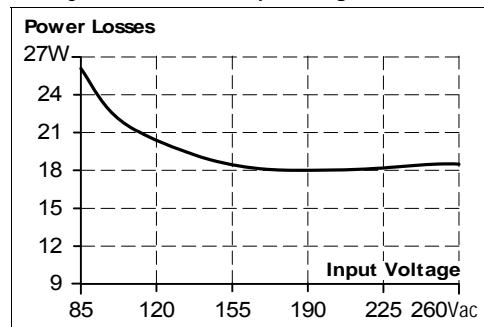
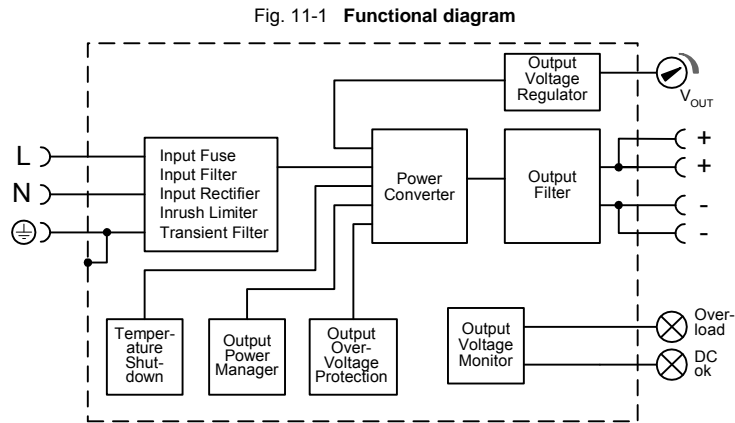

Fig. 10-4 Losses vs. input voltage, 24V, 10A



1606-XLS80E 24V, 3.4A; Single Phase Input

11. FUNCTIONAL DIAGRAM



12. PRODUCT FACE LABEL

Fig. 12-1 Front side

Output Terminals

Quick-connect spring-clamp terminals, no tools required

- + Positive output
- Negative (return) output
- Dual pins per pole

80W Continuous power /
120W Peak power

Input Terminals

Quick-connect spring-clamp terminals, no tools required

- N ... Neutral input
- L ... Line (hot) input
- ⊕ ... PE (Protective Earth) input

See chapter 13 "Terminals and Wiring" to choose appropriate wire gauges



Output voltage potentiometer

(multi turn potentiometer)
Open the flap to tune the output voltage.
Factory setting: 24.1V

- DC-ok lamp (green)
- Overload lamp (red)

	Overload LED	DC-ok LED
Normal mode	OFF	ON
Power-Boost mode	OFF	ON
Overload ($V_{OUT} < 90\%$, $> 80\%$)	ON	ON
Overload ($V_{OUT} < 80\%$)	ON	OFF
Short-circuit ($V_{OUT} = \text{ca. } 0V$)	ON	OFF
Over-temperature	Intermitted	Intermitted
No input power	OFF	OFF
Voltage fed back to the output terminals	OFF	ON

1606-XLS80E 24V, 3.4A; Single Phase Input

13. TERMINALS AND WIRING

Type	Bi-stable, quick-connect spring clamp terminals. IP20 Finger safe construction. Suitable for field- and factory installation. Shipped in open position.
Ferrules	allowed, but not required
Pull-out force	10AWG:80N, 12AWG:60N, 14AWG:50N, 16AWG:40N (according to UL486E)

	Input terminals	Output terminals
Solid wire	0.5-6mm ²	0.3-4mm ²
Stranded wire	0.5-4mm ²	0.3-2.5mm ²
American wire gauge	20-10 AWG	26-12 AWG
Wire stripping length	10mm / 0.4inch	6mm / 0.25inch

Fig. 13-1 Connecting a wire

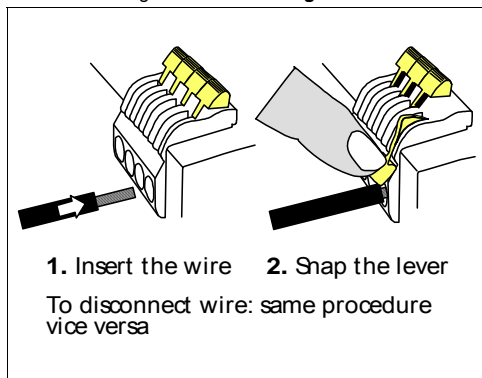

Instructions:

- Use appropriate copper cables that are designed for an operating temperature of:
60°C for ambient up to 45°C and
75°C for ambient up to 60°C minimum.
- Follow national installation codes and installation regulations!
- Ensure that all strands of a stranded wire enter the terminal connection!
- Up to two stranded wires with the same cross section are permitted in one connection point (except PE wire).
- Do not use the unit without PE connection.

14. RELIABILITY

		AC 100V	AC 120V	AC 230V	
Lifetime expectancy	min.	48 000h	62 000h	79 000h	40°C, 24V, 3.4A
	min.	117 000h	126 000h	114 000h	40°C, 24V, 1.7A
	min.	136 000h	15 years	15 years	25°C, 24V, 3.4A
MTBF SN 29500, IEC 61709		1 191 000h	1 265 000h	1 451 000h	40°C, 24V, 3.4A
		2 061 000h	2 155 000h	2 436 000h	25°C, 24V, 3.4A
MTBF MIL HDBK 217F		581 000h	631 000h	643 000h	40°C, 24V, 3.4A, Ground Benign GB40
		812 000h	889 000h	912 000h	25°C, 24V, 3.4A, Ground Benign GB25

The **Lifetime expectancy** shown in the table indicates the operating hours (service life) and is determined by the lifetime expectancy of the built-in electrolytic capacitors.

Lifetime expectancy is specified in operational hours. Lifetime expectancy is calculated according to the capacitor's manufacturer specification. The prediction model allows a calculation of up to 15 years from date of shipment.

MTBF stands for **Mean Time Between Failure**, which is calculated according to statistical device failures, and indicates reliability of a device. It is the statistical representation of the likelihood of the unit to fail and does not necessarily represent the life of a product.

1606-XLS80E 24V, 3.4A; Single Phase Input

15. EMC

The power supply is suitable for applications in industrial environment as well as in residential, commercial and light industry environment without any restrictions. CE mark is in conformance with EMC guideline 89/336/EEC and 93/68/EEC and the low-voltage directive (LVD) 73/23/EWG.

EMC Immunity	EN 61000-6-1 EN 61000-6-2		Generic standards	
Electrostatic discharge	EN 61000-4-2	Contact discharge	8kV	Criterion A
		Air discharge	15kV	Criterion A
Electromagnetic RF field	EN 61000-4-3	80MHz-1GHz	10V/m	Criterion A
Fast transients (Burst)	EN 61000-4-4	Input lines	4kV	Criterion A
		Output lines	2kV	Criterion A
Surge voltage on input	EN 61000-4-5	L → N	2kV	Criterion A
		N / L → PE	4kV	Criterion A
Surge voltage on output	EN 61000-4-5	+ → -	500V	Criterion A
		+ / - → PE	500V	Criterion A
Conducted disturbance	EN 61000-4-6	0.15-80MHz	10V	Criterion A
Mains voltage dips	EN 61000-4-11	70% of 100Vac	70Vac, 10ms	Criterion A
		40% of 100Vac	40Vac, 100ms	Criterion C
		40% of 100Vac	40Vac, 1000ms	Criterion C
Voltage interruptions	EN 61000-4-11		0Vac, 5000ms	Criterion C
Voltage sags	SEMI F47 0200		96Vac, 1000ms	Criterion A
			84Vac, 500ms	Criterion A
			60Vac, 200ms	Criterion A
Input voltage swells	RA internal standard		300Vac, 500ms	Criterion A
Powerful transients	VDE 0160	over entire load range	750V, 1.3ms	Criterion A

Criteria:

A: Power supply shows normal operation behavior within the defined limits.

C: Temporary loss of function is possible. Power supply might shut-down and restarts by itself. No damages or hazards for the power supply occur.

EMC Emission	EN 61000-6-3 and EN 61000-6-4	Generic standards
Conducted emission	EN 55011, EN 55022, FCC Part 15, CISPR 11, CISPR 22	Class B, input lines
	EN 55022	Class A, output lines
Radiated emission	EN 55011, EN 55022	Class B
Harmonic input current	EN 61000-3-2	Fulfilled, active PFC
Voltage fluctuations, flicker	EN 61000-3-3	Fulfilled

This device complies with FCC Part 15 rules.

Operation is subjected to following two conditions: (1) this device may not cause harmful interference, and (2) this device must accept any interference received, including interference that may cause undesired operation.

Switching Frequency	65 to 270kHz	load and input voltage dependent
----------------------------	--------------	----------------------------------

1606-XLS80E 24V, 3.4A; Single Phase Input

16. ENVIRONMENT

Operational temperature	-25°C to +70°C (-13°F to 158°F)	reduce output power above +60°C
Output de-rating	2W/°C	60-70°C (140°F to 158°F), see Fig. 16-1
Storage temperature	-40 to +85°C (-40°F to 185°F)	storage and transportation
Humidity	5 to 95% r.H.	IEC 60068-2-30 Do not energize while condensation is present
Vibration sinusoidal	2-17.8Hz: ±1.6mm; 17.8-500Hz: 2g 2 hours / axis	IEC 60068-2-6
Vibration random	0.5m ² (s ³) 2 hours / axis	IEC 60068-2-64
Shock	30g 6ms, 20g 11ms 3 bumps / direction, 18 bumps in total	IEC 60068-2-27
Altitude	0 to 6000m (0 to 20 000ft)	Reduce output power or ambient temperature above 2000m sea level.
Output de-rating (for altitude)	5W/1000m or 5°C/1000m	above 2000m (6500ft), see Fig. 16-2
Over-voltage category	III II	EN 50178, altitudes up to 2000m Altitudes from 2000m to 6000m
Degree of pollution	2	EN 50178, not conductive

Fig. 16-1 Output wattage vs. ambient temp.,

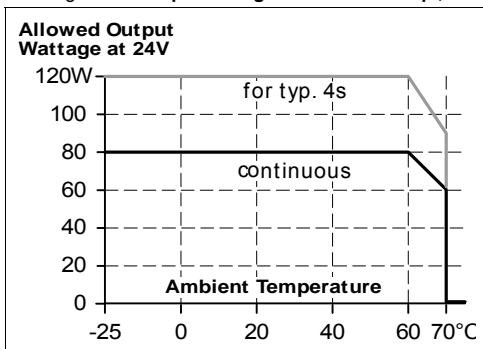
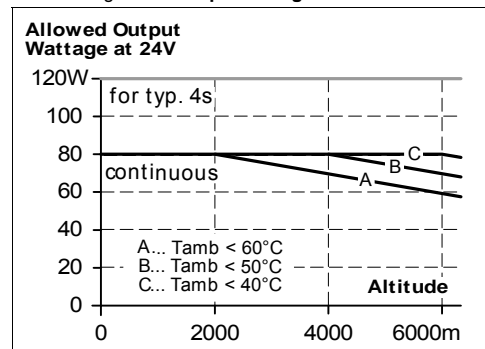

Fig. 16-2 Output wattage vs. altitude



The ambient temperature is defined as the air temperature 2cm below the unit.

1606-XLS80E 24V, 3.4A; Single Phase Input

17. PROTECTION FEATURES

Output protection	Electronically protected against overload, no-load and short-circuits	
Output over-voltage protection	typ. 34Vdc max. 36Vdc	In case of an internal power supply defect, a redundant circuitry limits the maximum output voltage. The output shuts-down and automatically attempts to restart.
Output over-current protection	Electronically limited	See Fig. 8-1
Degree of protection	IP 20	EN/IEC 60529
Penetration protection	> 3.5mm	e.g. screws, small parts
Over-temperature protection	yes	output shut-down with automatic restart
Input transient protection	MOV (Metal Oxide Varistor) and active transient filter	
Internal input fuse	T6.3A H.B.C.	not user replaceable

Note: In case of a protection event, audible noise may occur.

18. SAFETY

Input / output separation	SELV	IEC/EN 60950-1
	PELV double or reinforced insulation	EN 60204-1, EN 50178, IEC 60364-4-41
Class of protection	I	PE (Protective Earth) connection required
Isolation resistance	> 5M Ω	input to output, 500Vdc
PE resistance	< 0.1 Ω	between housing and PE terminal
Touch current (leakage current)	typ. 0.19mA	100Vac, 50Hz, TN mains
	typ. 0.29mA	120Vac, 60Hz, TN mains
	typ. 0.53mA	230Vac, 50Hz, TN mains
	< 0.25mA	110Vac, 50Hz, TN mains
	< 0.38mA	132Vac, 60Hz, TN mains
	< 0.74mA	264Vac, 50Hz, TN mains

19. DIELECTRIC STRENGTH

WARNING

To fulfill the PELV requirements according to EN60204-1 § 6.4.1, we recommend that either the + pole, the – pole or any other part of the output circuit shall be connected to the protective earth system. This helps to avoid situations in which a load starts unexpectedly or can not be switched off any more when unnoticed earth faults occur.

Fig. 19-1 Dielectric strength

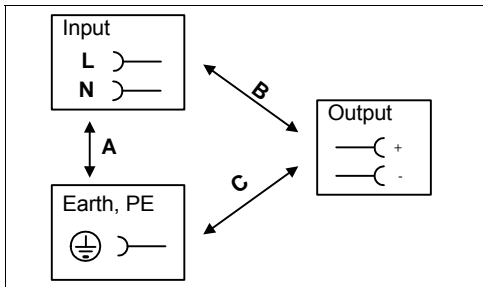

		A	B	C
Type test	60s	2500Vac	3000Vac	500Vac
Factory test	5s	2500Vac	2500Vac	500Vac
Field test	5s	2000Vac	2000Vac	500Vac

Type tests and factory tests:

Conducted by the manufacturer. Do not repeat test in field!

Rules for field test:





Use appropriate test equipment which applies the voltage with a slow ramp! Connect L and N together as well as all output poles.

The output voltage is floating and has no ohmic connection to ground.

Rockwell Automation

1606-XLS80E 24V, 3.4A; Single Phase Input

20. APPROVALS

IEC 60950-1		CB Scheme, Information Technology Equipment
UL 508		LISTED E198865 listed for use in U.S.A. (UL 508) and Canada (C22.2 No. 14-95) Industrial Control Equipment
UL 60950-1		RECOGNIZED E137006 recognized for the use in U.S.A. (UL 60950-1) and Canada (C22.2 No. 60950) Information Technology Equipment, Level 5
UL 1604		RECOGNIZED E246877 recognized for use in U.S.A. (UL 1604) and Canada (C22.2 No. 213-M1987) Hazardous Location Class I Div 2 T4 Groups A,B,C,D and Class I Zone 2 Groups IIA, IIB and IIC
<p>The unit is suitable for use in Class I Division 2 Groups A, B, C, D locations as well as for Class I Zone 2 Groups IIA, IIB and IIC locations. Substitution of components may impair suitability for Class I Division 2 environment. Do not disconnect equipment unless power has been switched off. Wiring must be in accordance with Class I, Division 2 wiring methods of the National Electrical Code, NFPA 70, and in accordance with other local or national codes.</p>		
SEMI F47		SEMI F47-0200 Power Quality Star Ride-through compliance for semiconductor industry. Full SEMI range compliance (Input: 120Vac or 208Vac, output: 240W)

21. FULFILLED STANDARDS

EN 61558-2-17	Safety of Power Transformers
EN/IEC 60204-1	Safety of Electrical Equipment of Machines
EN/IEC 61131-2	Programmable Controllers
EN 50178	Electronic Equipment in Power Installations

22. USED SUBSTANCES

The unit does not release any silicone and is suitable for the use in paint shops.

Electrolytic capacitors included in this unit do not use electrolytes such as Quaternary Ammonium Salt Systems.

Plastic housings and other molded plastic materials are free of halogens, wires and cables are not PVC insulated.

The production material within our production does not include following toxic chemicals:

Polychlorized Biphenyl (PCB), Polychlorized Terphenyl (PCT), Pentachlorophenol (PCP), Polychlorinated naphthalene (PCN), Polybrom Biphenyl (PBB), Polybrom Bipheny-oxyd (PBO), Polybrominated Diphenylether (PBDE), Polychlorinated Diphenylether (PCDE), Polydibromphenyl Oxyd (PBDO), Cadmium, Asbest, Mercury, Silicia

1606-XLS80E 24V, 3.4A; Single Phase Input

23. PHYSICAL DIMENSIONS AND WEIGHT

Weight	440g / 0.97lb
DIN-Rail	Use 35mm DIN-rails according to EN 60715 or EN 50022 with a height of 7.5 or 15mm. The DIN-rail height must be added to the depth (102mm) to calculate the total required installation depth.

Fig. 23-1 Front view

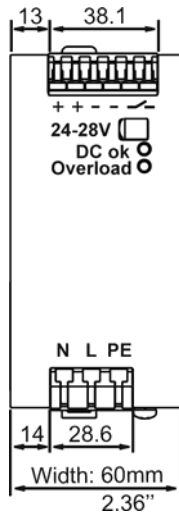
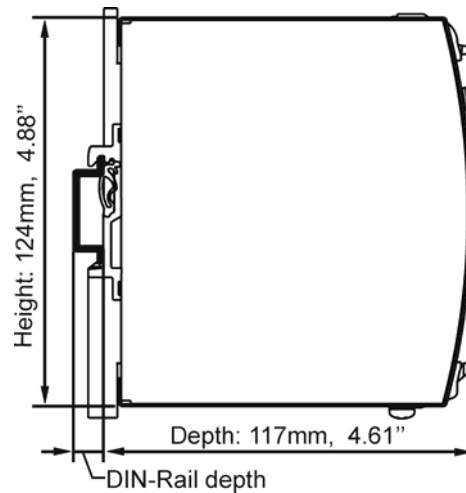

Fig. 23-2 Side view



24. INSTALLATION AND OPERATION INSTRUCTIONS

⚠ WARNING

Hazardous voltage inside device. Risk of electric shock, severe burns, or death.

- Do not use the unit without proper earth connection (Protective Earth). Use the pin on the terminal block for earth connection and not one of the screws on the housing.
- Turn power off before working on the power supply. Protect against inadvertent re-powering.
- Make sure the wiring is correct by following all local and national codes.
- Do not open, modify or repair the unit.
- Use caution to prevent any foreign objects from entering into the housing.
- Do not use in wet locations or in areas where moisture or condensation can be expected.

Mounting Orientation:

Output terminal must be located on top and input terminal on the bottom. For other orientations see section 26.14.

Cooling:

Convection cooled, no forced cooling required. Do not cover ventilation grid (e.g. cable conduits) by more than 30%!

Installation clearances:

40mm on top, 20mm on the bottom, 5mm on the left and right side are recommended when loaded permanently with full power. In case the adjacent device is a heat source, 15mm clearance is recommended.

Service parts:

The unit does not contain any serviceable parts. The tripping of an internal fuse is caused by an internal defect.

1606-XLS80E 24V, 3.4A; Single Phase Input

25. ACCESSORIES

1606-XLB Wall mounting bracket

This bracket is used to mount 1606 units onto a flat surface without utilizing a DIN-Rail. The two aluminum brackets and the black plastic slider of the unit have to be detached, so that the two steel brackets can be mounted.

Fig. 25-1 1606-XLB Wall Mounting Bracket

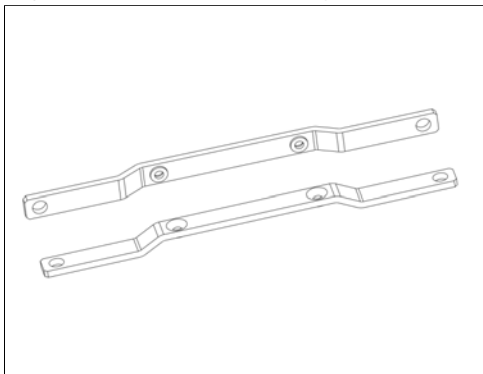
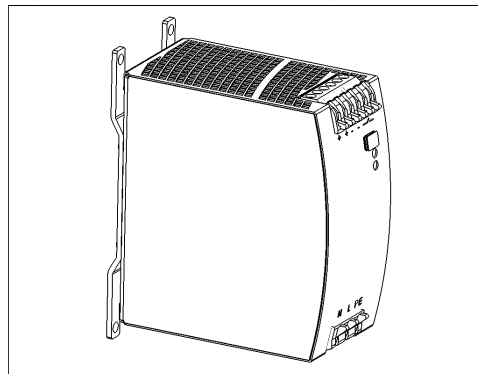

Fig. 25-2 Assembled Wall Mounting Bracket



1606-XLS80E 24V, 3.4A; Single Phase Input

26. APPLICATION NOTES

26.1. REPETITIVE PULSE LOADING

Typically, a load current is not constant. It varies over time. For pulse load compatibility, following rules must be met:

- The pulse power demand must be below 150% of the nominal power.
- The duration of the pulse power must be shorter than the allowed Power-Boost. (see output section)
- The average (R.M.S.) output current must be below the specified continuous output current.
If the R.M.S. current is higher, the unit might respond with a thermal shut-down after a while. Use the max. duty cycle curve (Fig. 26-2) to check if the average output current is below the nominal current.
- For altitudes higher than 2000m reduce the pulse loading (15W/1000m) or the ambient temperature (5°C/1000m)

Fig. 26-1 Repetitive pulse loads, definitions

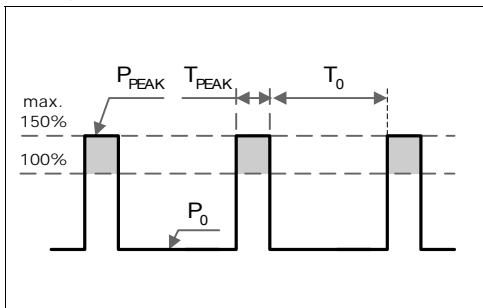

- P₀** Base load (W)
- P_{PEAK}** Pulse load (above 100%)
- T₀** Duration between pulses (s)
- T_{PEAK}** Pulse duration (s)

Fig. 26-2 Max. Duty Cycle Curve

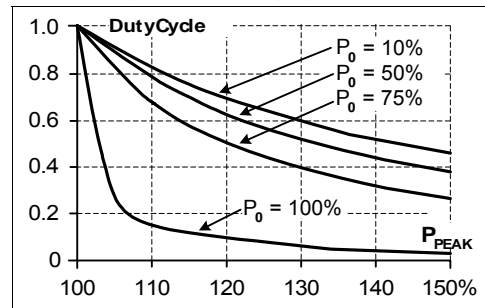

$$\text{DutyCycle} = \frac{T_{\text{peak}}}{T_{\text{peak}} + T_0}$$

$$T_0 = \frac{T_{\text{peak}} - (\text{DutyCycle} \times T_{\text{peak}})}{\text{DutyCycle}}$$

Utilizing the Max. Duty Cycle Curve:

Example to determine the repetition rate of pulses without dipping of the output voltage:

Parameters of application:

- Pulse length is T_{PEAK} = 1s
- Steady state load P₀=120W
(= 50% of I_{RATED})
- Peak load P_{PEAK} = 360W
(= 150% of I_{RATED})

Determining the repetition rate:

- make a vertical line at P_{PEAK} = 150%
- make a horizontal line where the vertical line crosses the P₀ = 50% curve
- Read the Max. Duty Cycle from the Duty Cycle-axis (= 0.37)
- Calculate the min. pause (base load) length T₀ :

$$T_0 = \frac{T_{\text{peak}} - (\text{DutyCycle} \times T_{\text{peak}})}{\text{DutyCycle}} = \frac{1\text{s} - (0.37 \times 1\text{s})}{0.37} = \underline{1.7\text{s}}$$

- Pulse length = 1s, min. pause length = 1.7s
- Max. repetition rate = pulse length + pause length = **2.7s**

More examples for pulse load compatibility:

P _{PEAK}	P ₀	T _{PEAK}	T ₀
120W	80W	1s	>25s
120W	0W	1s	>1.3s
100W	40W	1s	> 0,75s

P _{PEAK}	P ₀	T _{PEAK}	T ₀
120W	40W	0.1s	>0.16s
120W	40W	1s	>1.6s
120W	40W	3s	>4.9s

1606-XLS80E 24V, 3.4A; Single Phase Input

26.2. PEAK CURRENT CAPABILITY

Solenoids, contactors and pneumatic modules often have a steady state coil and a pick-up coil. The inrush current demand of the pick-up coil is several times higher than the steady state current and usually exceeds the nominal output current (including the Power-Boost) The same situation applies, when starting a capacitive load.

Branch circuits are often protected with circuit breakers or fuses. In case of a short or an overload in the branch circuit, the fuse needs a certain amount of over-current to trip or to blow. The peak current capability ensures the safe operation of subsequent circuit breakers.

Assuming the input voltage is turned on before such an event, the built-in large sized output capacitors inside the power supply can deliver extra current. Discharging this capacitor causes a voltage dip on the output. The following two examples show typical voltage dips:

Fig. 26-3 Peak load 6.8A for 50ms, typ.

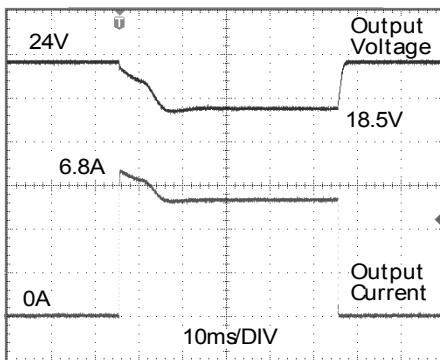

Peak load 6.8A (resistive) for 50ms
Output voltage dips from 24V to 18.5V.

Fig. 26-4 Peak load 13.5A for 5ms, typ.

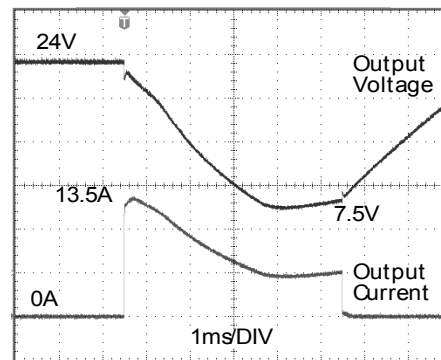

Peak load 13.5A (resistive) for 5ms
Output voltage dips from 24V to 7.5V.

26.3. BACK-FEEDING LOADS

Loads such as decelerating motors and inductors can feed voltage back to the power supply. This feature is also called return voltage immunity or resistance against Back- E.M.F. (Electro Magnetic Force).

This power supply is resistant and does not show malfunctioning when a load feeds back voltage to the power supply. It does not matter, whether the power supply is on or off.

The maximum allowed feed back voltage is 35Vdc. The absorbing energy can be calculated according to the built-in large sized output capacitor which is specified in chapter 8.

26.4. CHARGING OF BATTERIES

The power supply can be used for float-charging of lead-acid or maintenance free 24V VRLA batteries.

Instructions for charging batteries:

- a) Set the output voltage, at disconnected load, very precisely to the end-of-charge voltage according to the expected battery temperature.

End-of-charge voltage	27.8V	27.5V	27.15V	26.8V
Battery temperature	10°C	20°C	30°C	40°C

- b) Use a 15A or 16A circuit breaker (or blocking diode) between the power supply and the battery.
- c) Ensure that the output current of the power supply is below the allowed charging current of the battery.
- d) Use only matched batteries when putting 12V types in series.
- e) The return current to the power supply is typ. 6.3mA at 25Vdc when the power supply is switched off (except in case a blocking diode is utilized).

1606-XLS80E 24V, 3.4A; Single Phase Input

26.5. OUTPUT CIRCUIT BREAKERS

Standard miniature circuit breakers (MCBs) can be used for branch protection. Ensure that the MCB is rated for DC voltage, too. The following tests show which circuit breakers the power supply typically trips.

Circuit breakers have huge tolerances in their tripping behavior. Therefore, these typical tests can only be used as a recommendation or for comparing two different power supplies. Furthermore, the loop impedance has a major influence on whether a breaker trips or not. Two tests were performed, representing typical situations:

Test 1: Short circuit with S1 on the power supply end of the cable (loop impedance approx. 20mOhm)

Fig. 26-5 Branch protectors, test circuit 1

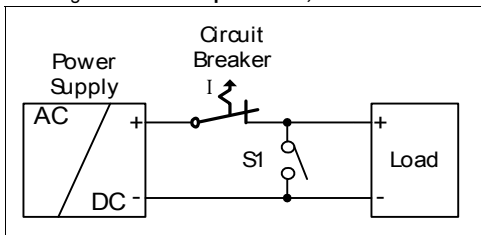

Parameters:

Input voltage: 230Vac, load current: 0A
 Tripping time shorter than 5s.

The following circuit breaker tripped during the test:

A- or Z- Characteristic: equal or smaller 6A
 C- Characteristic: equal or smaller 1A

Test 2: Short circuit with S1 on the load end (additional impedance included; represents longer load wire length).

Fig. 26-6 Branch protectors, test circuit 2

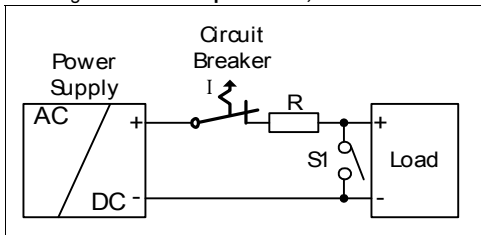

Parameters:

Input voltage: 230Vac, load current: 0A
 Tripping time shorter than 5s.

The following circuit breaker tripped during the test:

A- or Z- Characteristic: ≤ 6A and R < 180mOhm
 C- Characteristic: ≤ 1A and R < 390mOhm

What does this resistance mean in wire length?

	0.5mm ²	0.7mm ²	1.0mm ²	1.5mm ²	2.5mm ²	4.0mm ²
180mOhm	10.9m	15.2m	21.7m	32.6m	54.3m	86.9m
220mOhm	6.1m	8.6m	12.3m	18.4m	30.6m	49.0m

Example:

Which wire gauge must be used to trip a Z-Characteristic circuit breaker with a rating of 6A? The load wire length is 21m.

Answer: A 6A Z-Characteristic circuit breaker requires a loop impedance of less than 180mOhm (test results). The wire length table shows that up to 25.1m wire with a cross section of 2.5mm² are below 180mOhm. A wire not smaller than 2.5mm² shall be used.

26.6. EXTERNAL INPUT PROTECTION

The unit is tested and approved for branch circuits up to 20A. External protection is only required, if the supplying branch has an ampacity greater than this. In some countries local regulations might apply. Check also local codes and local requirements.

If an external fuse is necessary or utilized, a minimum value is required to avoid undesired tripping of the fuse.

		B-Characteristic	C-Characteristic
Ampacity	max.	20A	20A
	min.	6A	6A

1606-XLS80E 24V, 3.4A; Single Phase Input

26.7. PARALLEL USE TO INCREASE OUTPUT POWER

Power supplies can be paralleled to increase the output power.

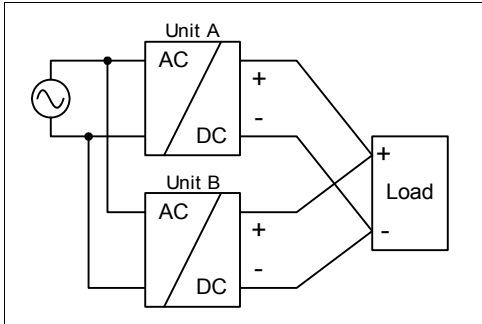

- Use only power supplies from the same series.
- A fuse (or diode) on the output is only required if more than three units are connected in parallel.
- Do not load terminals with more than 25A. Follow wiring instructions according to chapter 0
- Keep an installation clearance of 15mm (left/right) between two power supplies and avoid installing the power supplies on top of each other.

26.8. PARALLEL USE FOR REDUNDANCY

Power supplies can be paralleled for 1+1 redundancy to gain a higher system availability. Redundant systems require a certain amount of extra power to support the load in case one power supply unit fails. The simplest way is to put two 1606-XLS80E power supplies in parallel. In case one power supply unit fails, the other one is automatically able to support the load current without any interruption. This simple way to build a redundant system has two major disadvantages:

- The faulty power supply can not be recognized. The green LED will still be on since it is reverse-powered from the other power supply.
- It does not cover failures such as an internal short circuit in the secondary side of the power supply. In such a (nearly impossible) case, the defective unit becomes a load for the other power supplies and the output voltage can not be maintained any more.

This can only be avoided by utilizing decoupling diodes which are included in the decoupling module 1606-XLSRED or redundancy module 1606-XLERED with alarm contacts.

Recommendations for building redundant power systems:

- Use separate input fuses for each power supply.
- Monitor the individual power supply units. A DC-ok lamp and a DC-ok contact is included in the redundancy module 1606-XLERED. This feature reports a faulty unit.
- When possible, connect each power supply to different phases or circuits.

26.9. DAISY CHAINING OF OUTPUTS

Daisy chaining (jumping from one power supply output to the next) is allowed as long as the maximum current through one terminal pin does not exceed 25A. If the current is higher, use a separate distribution terminal block.

Fig. 26-7 Daisy chaining of outputs

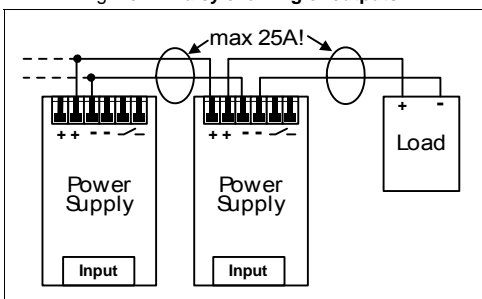
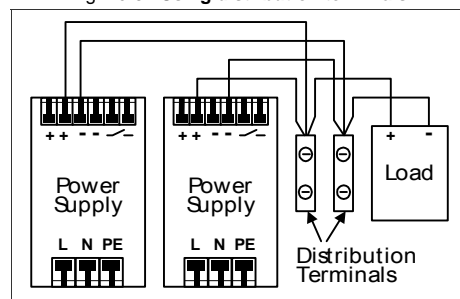

Fig. 26-8 Using distribution terminals



1606-XLS80E 24V, 3.4A; Single Phase Input

26.10. SERIES OPERATION

The power supply can be put in series to increase the output voltage.

Fig. 26-9 Schematic for series operation

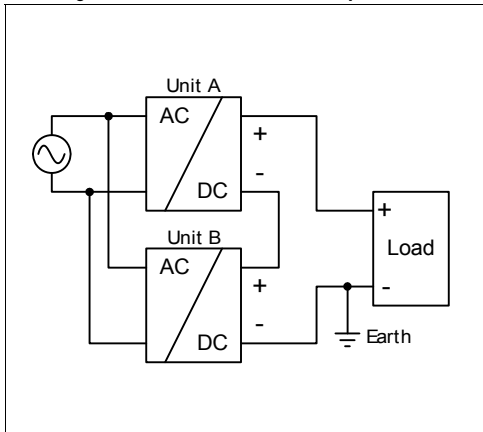

Instructions for use in series:

- It is possible to connect as many units in series as needed, providing the sum of the output voltage does not exceed 150Vdc.
- Warning !** Voltages with a potential above 60Vdc are not SELV any more and can be dangerous. Such voltages must be installed with a protection against touching.
- For serial operation use power supplies of the same type.
- Earthing of the output is required when the sum of the output voltage is above 60Vdc.
- Keep an installation clearance of 15mm (left/right) between two power supplies and avoid installing the power supplies on top of each other.

Note: Avoid return voltage (e.g. from a decelerating motor or battery) which is applied to the output terminals.

26.11. INDUCTIVE AND CAPACITIVE LOADS

The unit is designed to supply any kind of load, including unlimited capacitive and inductive loads.

26.12. OPERATION ON TWO PHASES

Fig. 26-10 Schematic for two phase operation

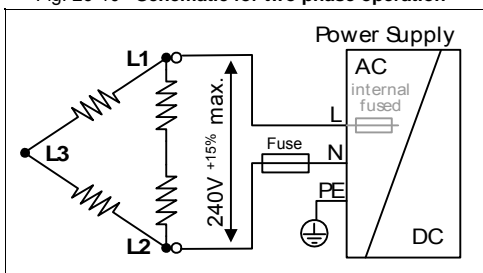

Instructions for two phase operation:

- A phase to phase connection is allowed as long as the supplying voltage is below 240V(+15%).
- Use a fuse or a circuit breaker to protect the N input. The N input is internally not protected and is in this case connected to a hot wire.

Appropriate fuses or circuit breakers are specified in section 0 "External Input Protection".

26.13. USE IN A TIGHTLY SEALED ENCLOSURE

When the power supply is installed in a tightly sealed enclosure, the temperature inside the enclosure will be higher than outside. The inside temperature defines the ambient temperature for the power supply.

Results from such an installation:

Power supply is placed in the middle of the box, no other heat producer inside the box

Enclosure:	Type IP66 Box PK 9516 100, plastic, 110x180x165mm
Load:	24V, 3.4A; (=100%) load is placed outside the box
Input:	230Vac
Temperature inside enclosure:	41.3°C (in the middle of the right side of the power supply with a distance of 2cm)
Temperature outside enclosure:	25.1°C
Temperature rise:	16.2°C

1606-XLS80E 24V, 3.4A; Single Phase Input

26.14. MOUNTING ORIENTATIONS

Mounting orientations other than input terminals on the bottom and output on the top require a reduction in continuous output power or a limitation in the max. allowed ambient temperature. The amount of reduction influences the lifetime expectancy of the power supply. Therefore, two different derating curves for continuous operation can be found below:

Curve A1 Recommended output current.

Curve A2 Max allowed output current (results approx. in half the lifetime expectancy of A1).

Fig. 26-11
Mounting
Orientation A
Standard Orientation

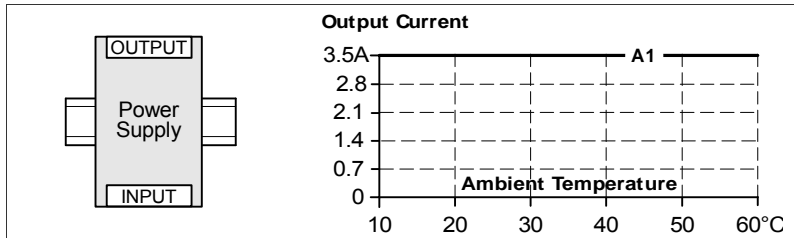

Fig. 26-12
Mounting
Orientation B
(Upside down)

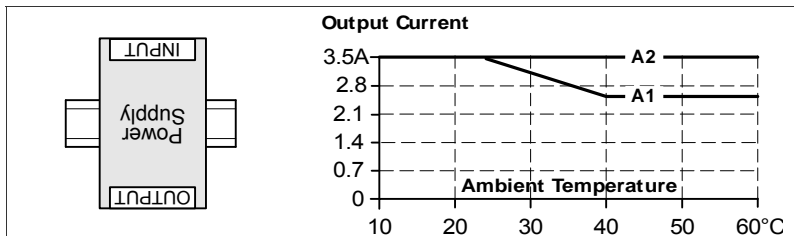

Fig. 26-13
Mounting
Orientation C
(Table-top mounting)

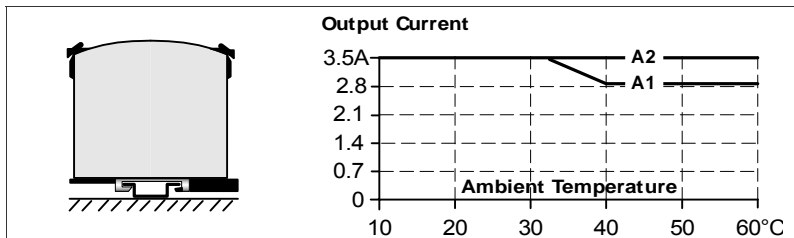

Fig. 26-14
Mounting
Orientation D
(Horizontal cw)

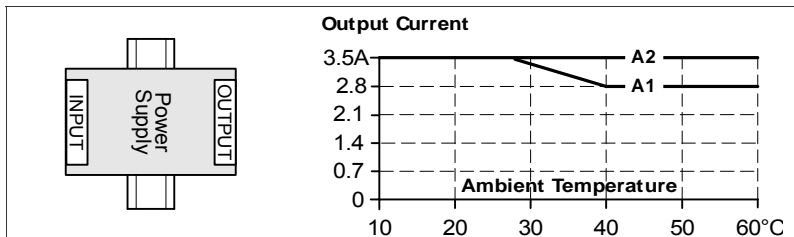

Fig. 26-15
Mounting
Orientation E
(Horizontal ccw)

