

## 1606-XLSDNET4 24V, 3.8A; Single Phase Input

# 1606-XLSDNET4

## 24V, 3.8A Single Phase Input

### POWER SUPPLY

- Ultra-small size
- Extra-low inrush current
- Active power factor correction
- Wide range AC/DC input; auto select input
- Superior reserve power (can support 150% rated power for five seconds)
- Superior efficiency and temperature rating
- DC-OK and overload LED



## 1. GENERAL DESCRIPTION

The 1606-XLSDNET4 power supply is a derivative of the Dimension XLS family, which is specially designed to meet the DeviceNet<sup>®</sup> requirement. The 1606-XLSDNET4 exists beside the 1606-XLSDNET8, which is the right choice to supply networks with the thick cable.

The specialties of DeviceNet<sup>®</sup> power supplies are:

- The nominal and overload currents are sized for the ratings of the DeviceNet<sup>®</sup> cables.
- Large load capacitors can be charged in a very short period of time.
- After turn on, the output voltage increases according to the DeviceNet<sup>®</sup> timing specification.
- The upper level of the output level is limited to protect the network.







The most outstanding features are a high efficiency, compact size, wide-range input voltage, a very low inrush surge and a DC-ok contact. High immunity to transients and power surges and a low electromagnetic emission makes usage in nearly every environment possible.

Unique quick-connect spring-clamp terminals allow a safe and fast installation. A large international approval package makes this unit suitable for nearly every situation.

## 2. SPECIFICATION QUICK REFERENCE

|                   |                   |                 |
|-------------------|-------------------|-----------------|
| Output voltage    | DC 24V            |                 |
| Adjustment range  | fixed             | not adjustable  |
| Output current    | 3.8A              |                 |
| Output power      | 91.2W             | continuous, 24V |
| Output ripple     | < 50mVpp          | 20Hz to 20MHz   |
| Input voltage     | AC 100-240V       | +10/-15%        |
| Line frequency    | 50-60Hz           | ±6%             |
| AC Input current  | 0.85 / 0.48A      | at 120 / 230Vac |
| Power factor      | 0.98 / 0.90       | at 120 / 230Vac |
| AC Inrush current | typ. 9 / 11A peak | at 120 / 230Vac |
| DC Input voltage  | DC 110-300V       | ±20%            |
| DC Input current  | 0.91 / 0.33A      | at 110 / 300Vdc |
| Efficiency        | 91.4 / 92.0%      | at 120 / 230Vac |
| Losses            | 8.6 / 7.9W        | at 120 / 230Vac |
| Temperature range | -25°C to +70°C    | operational     |
| Derating          | 2W/°C             | +60 to +70°C    |
| Hold-up time      | typ. 44 / 85ms    | at 120 / 230Vac |
| Dimensions        | 40x124x117mm      | WxHxD           |

## 3. AGENCY APPROVALS

|   |   |
|---|---|
| <br>IND. CONT. EQ.<br>UL 508 | <br>UL 60950-1 |
| <br>Class I Div 2            |                |
| <br>EMC, LVD                 |                |

## 4. RELATED PRODUCTS

|               |                              |
|---------------|------------------------------|
| 1606-XLSDNET8 | 8 AMP DeviceNet Power Supply |
| 1606-XLB      | Wall mount bracket           |
| 1606-XLSRED   | Redundancy Module            |
| 1606-XLBUFFER | Buffer unit                  |

# Rockwell Automation

## 1606-XLSDNET4 24V, 3.8A; Single Phase Input

| INDEX                                  | PAGE | INDEX   | PAGE |
|--|------|---|------|
| 1. General Description .....           | 1    | 19. Safety .....                                  | 12   |
| 2. Specification Quick reference ..... | 1    | 20. Dielectric Strength .....                     | 12   |
| 3. Agency Approvals .....              | 1    | 21. Approvals .....                               | 13   |
| 4. Related Products .....              | 1    | 22. Fulfilled Standards .....                     | 13   |
| 5. AC-Input .....                      | 3    | 23. Used Substances .....                         | 13   |
| 6. Input Inrush Current .....          | 4    | 24. Physical Dimensions and Weight .....          | 14   |
| 7. DC-Input .....                      | 4    | 25. Installation and Operation Instructions ..... | 14   |
| 8. Output .....                        | 5    | 26. Accessories .....                             | 15   |
| 9. Hold-up Time .....                  | 6    | 27. Application Notes .....                       | 16   |
| 10. DC-OK Relay Contact .....          | 6    | 27.1. Peak Current Capability .....               | 16   |
| 11. Efficiency and Power Losses .....  | 7    | 27.2. Back-feeding Loads .....                    | 16   |
| 12. Functional Diagram .....           | 8    | 27.3. Parallel and Serial Use .....               | 16   |
| 13. Product Face label .....           | 8    | 27.4. Output Circuit Breakers .....               | 17   |
| 14. Terminals and Wiring .....         | 9    | 27.5. External Input Protection .....             | 17   |
| 15. Reliability .....                  | 9    | 27.6. Inductive and Capacitive Loads .....        | 18   |
| 16. EMC .....                          | 10   | 27.7. Operation on Two Phases .....               | 18   |
| 17. Environment .....                  | 11   | 27.8. Use in a Tightly Sealed Enclosure .....     | 18   |
| 18. Protection Features .....          | 12   | 27.9. Mounting Orientations .....                 | 19   |

### INTENDED USE

Those responsible for the application and use of the products must satisfy themselves that all necessary steps have been taken to assure that each application and use meets all performance and safety requirements, including and applicable laws, regulation , codes, and standards.

### TERMINOLOGY AND ABBREVIATIONS

|  |  |
|--|--|
| <b>PE and <math>\oplus</math> symbol</b> | PE is the abbreviation for <b>Protective Earth</b> and has the same meaning as the symbol $\oplus$ .   |
| <b>Earth, Ground</b>                     | This document uses the term “earth” which is the same as the U.S. term “ground”.   |
| <b>T.b.d.</b>                            | To be defined, value or description will follow later.   |
| <b>AC 230V</b>                           | A figure displayed with the AC or DC before the value represents a nominal voltage with standard tolerances (usually $\pm 20\%$ ) included.<br>E.g.: DC 12V describes a 12V battery disregarding whether it is full (13.7V) or flat (10V)<br>As long as not otherwise stated, AC 100V and AC 230V parameters are valid at 50Hz and AC 120V parameters are valid at 60Hz mains frequency. |
| <b>230Vac</b>                            | A figure with the unit (Vac) at the end is a momentary figure without any additional tolerances included.  |
| <b>PELV</b>                              | Protective Extra Low Voltage   |
| <b>SELV</b>                              | Safety Extra Low Voltage   |

### DISCLAIMER

The information presented in this document is believed to be accurate and reliable and may change without notice.

## 1606- XLSDNET4 24V, 3.8A; Single Phase Input

### 5. AC-INPUT

|                   |      |             |   |
|-------------------|------|-------------|---|
| AC input          | nom. | AC 100-240V | wide-range input, see Fig. 5-1                      |
| AC input range    | min. | 85-264Vac   | continuous operation                                |
|                   | min. | 60-85Vac    | full power for 200ms, no damage between 0 and 85Vac |
|                   | min. | 264-300Vac  | < 500ms   |
| Input frequency   | nom. | 50 – 60Hz   | ±6%   |
| Turn-on voltage   | typ. | 82Vac       | steady-state value, see Fig. 5-1                    |
| Shut-down voltage | typ. | 78Vac       | steady-state value, see Fig. 5-1                    |

|                   |      | AC 100V | AC 120V | AC 230V |                              |
|-------------------|------|---------|---------|---------|------------------------------|
| Input current     | typ. | 1.02A   | 0.85A   | 0.48A   | at 24V, 3.8A, see Fig. 5-3   |
| Power factor *    | typ. | 0.99    | 0.98    | 0.90    | at 24V, 3.8A, see Fig. 5-4   |
| Crest factor **   | typ. | 1.48    | 1.55    | 1.71    | at 24V, 3.8A                 |
| Start-up delay    | typ. | 120ms   | 110ms   | 85ms    | see Fig. 5-2                 |
| Rise time         | typ. | 18ms    | 18ms    | 18ms    | 0mF, 24V, 3.8A, see Fig. 5-2 |
|                   | typ. | 38ms    | 38ms    | 38ms    | 5mF, 24V, 3.8A, see Fig. 5-2 |
| Turn-on overshoot | max. | 100mV   | 100mV   | 100mV   | see Fig. 5-2                 |

\* The power factor is the ratio of the true (or real) power to the apparent power in an AC circuit.

\*\* The crest factor is the mathematical ratio of the peak value to RMS value of the input current waveform.

Fig. 5-1 Input voltage range

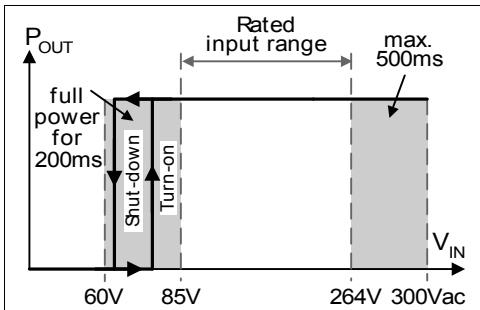

Fig. 5-2 Turn-on behavior, definitions

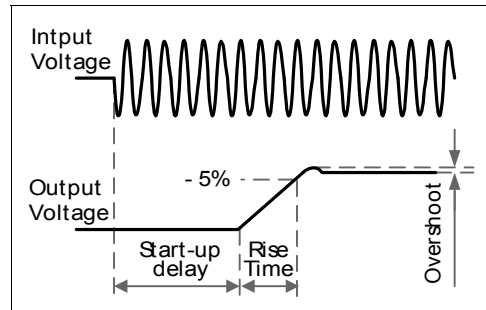

Fig. 5-3 Input current vs. output load at 24V

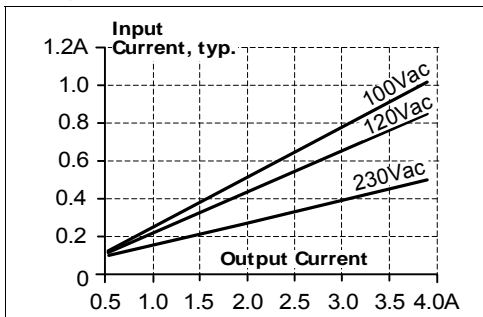
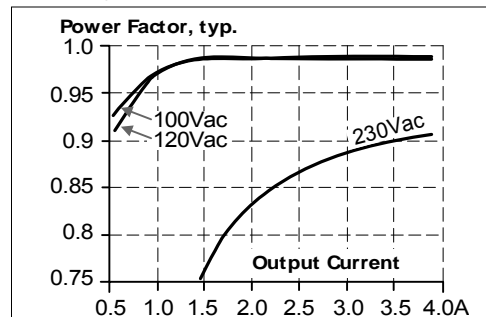

Fig. 5-4 Power factor vs. output load



## 1606- XLSDNET4 24V, 3.8A; Single Phase Input

### 6. INPUT INRUSH CURRENT

An active inrush limitation circuitry limits the input inrush current after turn-on of the input voltage and after short input voltage interruptions.

The charging current into EMI suppression capacitors is disregarded in the first milliseconds after switch-on.

|                |      | AC 100V             | AC 120V             | AC 230V             |                |
|----------------|------|---------------------|---------------------|---------------------|----------------|
| Inrush current | max. | 15A <sub>peak</sub> | 15A <sub>peak</sub> | 15A <sub>peak</sub> | -25°C to +70°C |
|                | typ. | 8A <sub>peak</sub>  | 9A <sub>peak</sub>  | 11A <sub>peak</sub> | -25°C to +70°C |
| Inrush energy  | max. | 1A <sup>2</sup> s   | 1A <sup>2</sup> s   | 1A <sup>2</sup> s   | -25°C to +70°C |

Fig. 6-1 Input inrush current, typical behavior

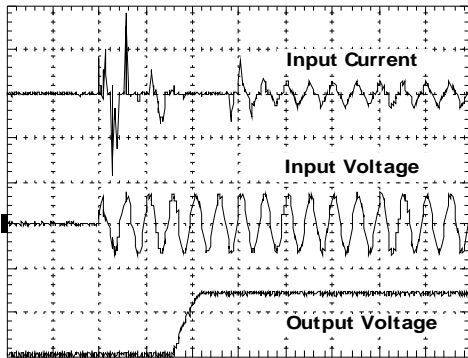

Input: 230Vac  
 Output: 24V, 3.8A  
 Ambient: 25°C  
 Upper curve: Input current 5A / DIV  
 Medium curve: Input voltage 500V / DIV  
 Lower curve: Output voltage 20V / DIV  
 Time basis: 40ms / DIV

### 7. DC-INPUT

|                   |      |               |                           |
|-------------------|------|---------------|---------------------------|
| DC input          | nom. | DC 110-300V   |                           |
| DC input range    | min. | 88-375Vdc     | continuous operation      |
| DC input current  | typ. | 2.37A / 0.87A | 110Vdc / 300Vdc, 24V, 10A |
| Turn-on voltage   | typ. | 80Vdc         | steady state value        |
| Shut-down voltage | typ. | 55Vdc         | steady state value        |

Fig. 7-1 Wiring for DC Input

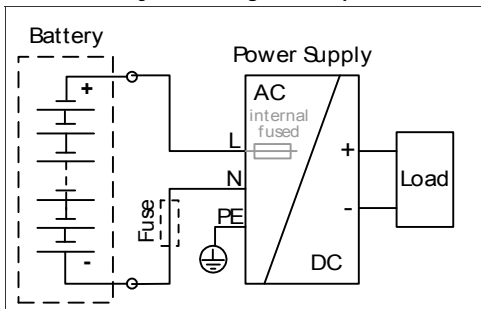

#### Instructions for DC use:

- Use a battery or similar DC source.
- Connect +pole to L and -pole to N.
- Connect the PE terminal to a earth wire or to the machine ground.

When the -pole of the battery is not connected to earth, use an appropriate fuse to protect the N terminal.

## 1606- XLSDNET4 24V, 3.8A; Single Phase Input

### 8. OUTPUT

|                          |      |         |   |
|--------------------------|------|---------|---|
| Output voltage           | nom. | 24V     |   |
| Adjustment range         | min. | fixed   | Not adjustable  |
| Line regulation          | max. | 20mV    | 85 to 264Vac  |
| Load regulation          | max. | 70mV    | static value, 0A → 3.8A → 0A  |
| Ripple and noise voltage | max. | 50mVpp  | 20Hz to 20MHz, 50Ohm  |
| Output capacitance       | typ. | 3 500μF |   |
| Output current           | nom. | 3.8A    | see <b>Error! Reference source not found.</b>                         |
|                          |      | 5.7A    | for typ. 200ms to charge network capacitors<br>(= Power-Boost)        |
| Output power             | nom. | 91.2W   | continuous  |
| Short-circuit current    | min. | 4.0A    | load impedance 200mOhm, see <b>Error! Reference source not found.</b> |
|                          | max. | 7.0A    | load impedance 200mOhm, see <b>Error! Reference source not found.</b> |

#### Peak current capability (up to several ms)

The power supply can deliver a peak current which is higher than the specified short term current. This helps to start current demanding loads or to safely operate subsequent circuit breakers.

The extra current is supplied by the output capacitors inside the power supply. During this event, the capacitors will be discharged and causes a voltage dip on the output. Detailed curves can be found in chapter 27.1.

|                           |      |                   |                  |
|---------------------------|------|-------------------|------------------|
| Peak current voltage dips | typ. | from 24V to 21.5V | at 7.6A for 20ms |
|                           | typ. | from 24V to 20.5V | at 15A for 2ms   |
|                           | typ. | from 24V to 17.5V | at 15A for 5ms   |

Fig. 8-1 Output voltage vs. output current, typ.

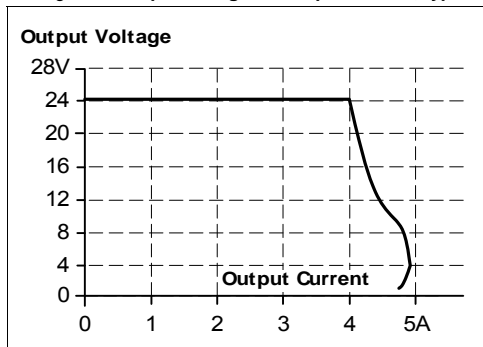

The Power-Boost is available as soon as power comes on and immediately after the end of an output short circuit.

Fig. 8-2 Power-Boost after input turn-on

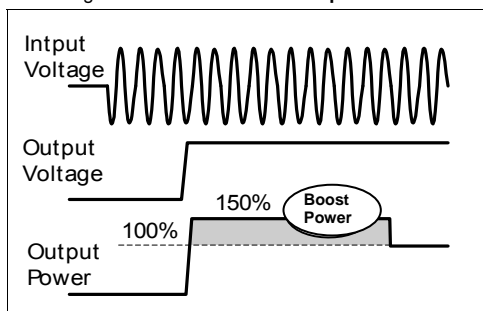
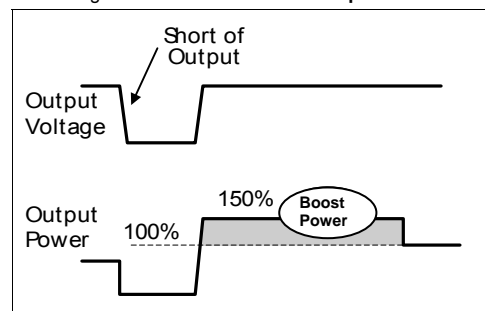

Fig. 8-3 Power-Boost after output short



# Rockwell Automation

## 1606- XLSDNET4 24V, 3.8A; Single Phase Input

### 9. HOLD-UP TIME

|              |      | AC 100V | AC 120V | AC 230V |                         |
|--------------|------|---------|---------|---------|-------------------------|
| Hold-up Time | typ. | 44ms    | 44ms    | 85ms    | 3.8A, 24V, see Fig. 9-1 |
|              | typ. | 87ms    | 87ms    | 167ms   | 1.9A, 24V, see Fig. 9-1 |

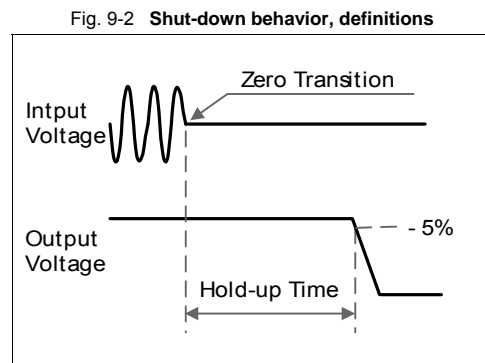
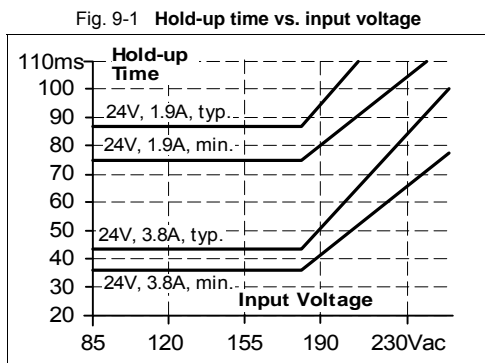

Note: At no load, the hold-up time can be up to one minute. The green DC-ok lamp is on during this time.

### 10. DC-OK RELAY CONTACT

This feature monitors the output voltage, which is produced by the power supply itself. It is independent of a back-fed voltage from a unit which is connected in parallel to the power supply output.

|                   |   |                                  |                       |
|-------------------|---|----------------------------------|-----------------------|
| Contact closes    | As soon as the output voltage reaches the adjusted output voltage.  |                                  |                       |
| Contact opens     | As soon as the output voltage dips more than 10% below the adjusted output voltage. Short dips will be extended to a signal length of 250ms. Dips shorter than 1ms will be ignored. |                                  |                       |
| Contact re-closes | As soon as the output voltage exceeds 90% of the adjusted voltage.  |                                  |                       |
| Contact ratings   | max   | 60Vdc 0.3A, 30Vdc 1A, 30Vac 0.5A | resistive load        |
|                   | min   | 1mA at 5Vdc                      | min. permissible load |
| Isolation voltage | See dielectric strength table in section 20   |                                  |                       |

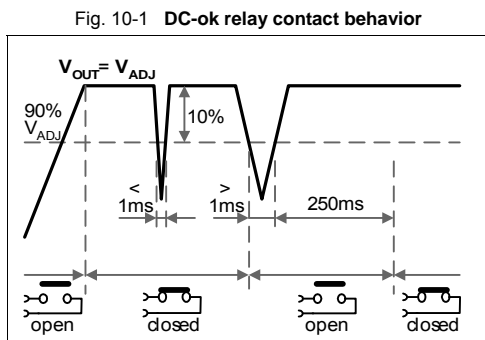

**Note:**

The DC-ok feature requires that the output voltage reaches the nominal (=adjusted) level after turn-on in order to function according to specification. If this level cannot be achieved, the overload lamp will be on and the DC-ok contact will be open. The overload signal will only shut off as soon as the adjusted voltage is reached. This is an important condition to consider particularly, if the load is a battery, the power supply is used in parallel or the power supply is used for N+1 redundant systems.

## 1606- XLSDNET4 24V, 3.8A; Single Phase Input

### 11. EFFICIENCY AND POWER LOSSES

|              |      | AC 100V | AC 120V | AC 230V |           |
|--------------|------|---------|---------|---------|-----------|
| Efficiency   | typ. | 90.4%   | 91.4%   | 92.0%   | 3.8A, 24V |
| Power losses | typ. | 9.7W    | 8.6W    | 7.9W    | 3.8A, 24V |
|              | typ. | 3.7W    | 3.8W    | 4.3W    | 0A, 24V   |

Fig. 11-1 Efficiency vs. output current at 24V

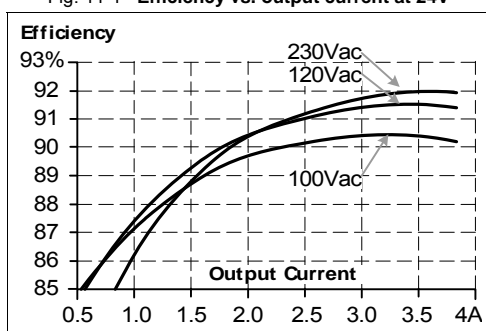

Fig. 11-2 Losses vs. output current at 24V

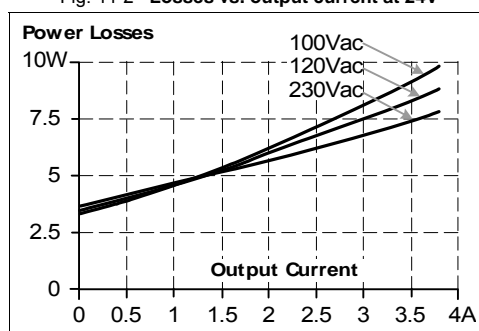

Fig. 11-3 Efficiency vs. input voltage, 24V, 3.8A

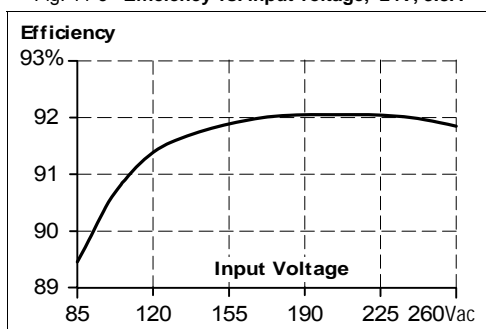
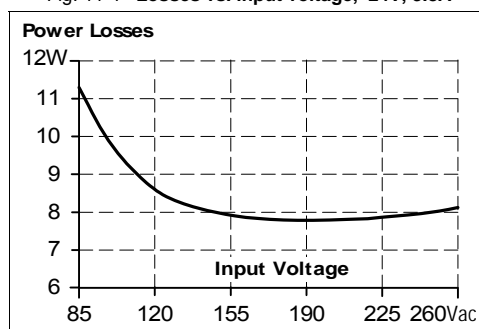
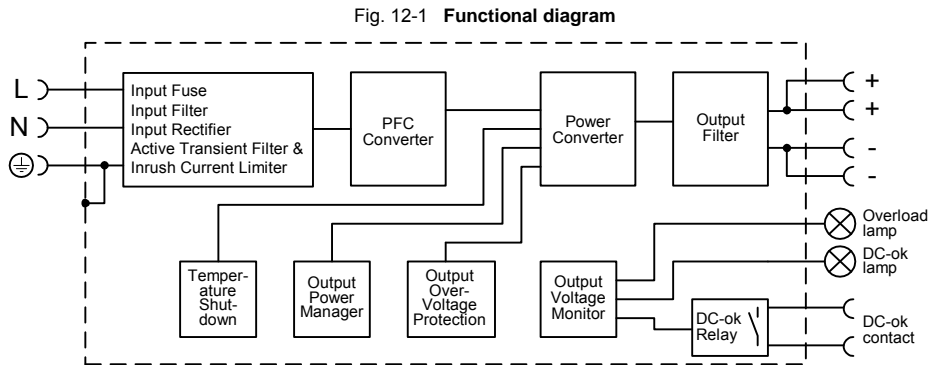

Fig. 11-4 Losses vs. input voltage, 24V, 3.8A



## 1606- XLSDNET4 24V, 3.8A; Single Phase Input

### 12. FUNCTIONAL DIAGRAM



### 13. PRODUCT FACE LABEL

Fig. 13-1 Front side

#### Output Terminals

Quick-connect spring-clamp terminals, no tools required

- + Positive output
- Negative (return) output  
Dual pins per pole
- DC ok Relay contact (NO-contact)

#### Input Terminals

Quick-connect spring-clamp terminals, no tools required

- N ... Neutral input
- L ... Line (hot) input
- ⊕ ... PE (Protective Earth) input

See chapter 14 "Terminals and Wiring" to choose appropriate wire gauges

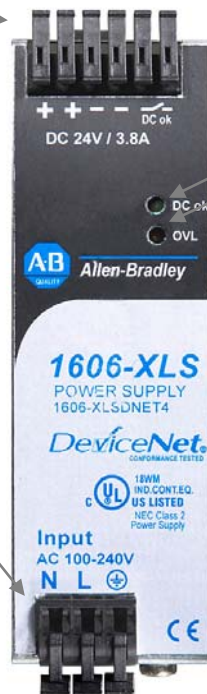

DC-ok lamp (green)  
Overload lamp (red)

|  | Overload LED | DC-ok LED | DC-ok LED |
|--|--------------|-----------|-----------|
| Normal mode                                  | OFF          | ON        | Closed    |
| Power-Boost Mode                             | OFF          | ON        | Closed    |
| Overload ( $V_{OUT} < 90\%$ )                | ON           | OFF       | Open      |
| Short-circuit ( $V_{OUT} = \text{ca. } 0V$ ) | ON           | OFF       | Open      |
| Over-temperature                             | Intermitted  | OFF       | Open      |
| No input power                               | OFF          | OFF       | Open      |

DC-ok lamp and DC-ok contact function synchronized



## 1606- XLSDNET4 24V, 3.8A; Single Phase Input

### 14. TERMINALS AND WIRING

|                |   |
|----------------|---|
| Type           | Bi-stable, quick-connect spring clamp terminals. IP20 Finger safe construction. Suitable for field- and factory installation. Shipped in open position. |
| Ferrules       | allowed, but not required   |
| Pull-out force | 10AWG:80N, 12AWG:60N, 14AWG:50N, 16AWG:40N (according to UL486E)  |

|                       | Input terminals      | Output and DC-OK-Signal terminals |
|-----------------------|----------------------|-----------------------------------|
| Solid wire            | 0.5-6mm <sup>2</sup> | 0.3-4mm <sup>2</sup>              |
| Stranded wire         | 0.5-4mm <sup>2</sup> | 0.3-2.5mm <sup>2</sup>            |
| American wire gauge   | 20-10 AWG            | 26-12 AWG                         |
| Wire stripping length | 10mm / 0.4inch       | 6mm / 0.25inch                    |

Fig. 14-1 Connecting a wire

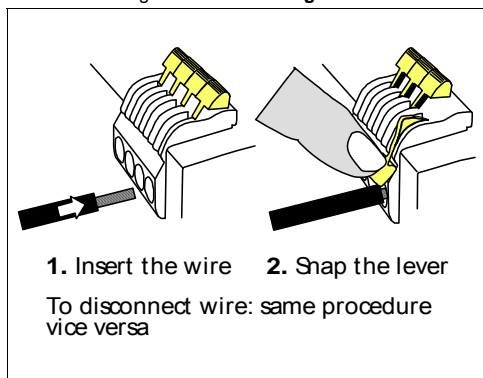

#### Instructions:

- Use appropriate copper cables that are designed for an operating temperature of:  
60°C for ambient up to 45°C and  
75°C for ambient up to 60°C minimum.
- Follow national installation codes and installation regulations!
- Ensure that all strands of a stranded wire enter the terminal connection!
- Up to two stranded wires with the same cross section are permitted in one connection point (except PE wire).
- Do not use the unit without PE connection.

### 15. RELIABILITY

|                          |      | AC 100V    | AC 120V    | AC 230V    |                                     |
|--------------------------|------|------------|------------|------------|-------------------------------------|
| Lifetime expectancy      | min. | 68 000h    | 75 000h    | 94 000h    | 40°C, 24V, 3.8A                     |
|                          | min. | 122 000h   | 126 000h   | 126 000h   | 40°C, 24V, 1.9A                     |
|                          | min. | 15 years   | 15 years   | 15 years   | 25°C, 24V, 3.8A                     |
| MTBF SN 29500, IEC 61709 |      | 787 000h   | 812 000h   | 831 000h   | 40°C, 24V, 3.8A                     |
|                          |      | 1 374 000h | 1 409 000h | 1 338 000h | 25°C, 24V, 3.8A                     |
| MTBF MIL HDBK 217F       |      | 352 000h   | 375 000h   | 391 000h   | 40°C, 24V, 3.8A, Ground Benign GB40 |
|                          |      | 482 000h   | 509 300h   | 536 000h   | 25°C, 24V, 3.8A, Ground Benign GB25 |

The **Lifetime expectancy** shown in the table indicates the operating hours (service life) and is determined by the lifetime expectancy of the built-in electrolytic capacitors.

Lifetime expectancy is specified in operational hours. Lifetime expectancy is calculated according to the capacitor's manufacturer specification. The prediction model allows a calculation of up to 15 years from date of shipment.

**MTBF** stands for **Mean Time Between Failure**, which is calculated according to statistical device failures, and indicates reliability of a device. It is the statistical representation of the likelihood of the unit to fail and does not necessarily represent the life of a product.

## 1606- XLSDNET4 24V, 3.8A; Single Phase Input

### 16. EMC

The power supply is suitable for applications in industrial environment as well as in residential, commercial and light industry environment without any restrictions. CE mark is in conformance with EMC guideline 89/336/EEC and 93/68/EEC and the low-voltage directive (LVD) 73/23/EWG.

| EMC Immunity             | EN 61000-6-1 EN 61000-6-2 |                        | Generic standards |             |
|--------------------------|---------------------------|------------------------|-------------------|-------------|
| Electrostatic discharge  | EN 61000-4-2              | Contact discharge      | 8kV               | Criterion A |
|                          |                           | Air discharge          | 15kV              | Criterion A |
| Electromagnetic RF field | EN 61000-4-3              | 80MHz-1GHz             | 10V/m             | Criterion A |
| Fast transients (Burst)  | EN 61000-4-4              | Input lines            | 4kV               | Criterion A |
|                          |                           | Output lines           | 2kV               | Criterion A |
| Surge voltage on input   | EN 61000-4-5              | L → N                  | 2kV               | Criterion A |
|                          |                           | N / L → PE             | 4kV               | Criterion A |
| Surge voltage on output  | EN 61000-4-5              | + → -                  | 500V              | Criterion A |
|                          |                           | + / - → PE             | 500V              | Criterion A |
| Conducted disturbance    | EN 61000-4-6              | 0.15-80MHz             | 10V               | Criterion A |
| Mains voltage dips       | EN 61000-4-11             | 70% of 100Vac          | 70Vac, 10ms       | Criterion A |
|                          |                           | 40% of 100Vac          | 40Vac, 100ms      | Criterion C |
|                          |                           | 40% of 100Vac          | 40Vac, 1000ms     | Criterion C |
| Voltage interruptions    | EN 61000-4-11             |                        | 0Vac, 5000ms      | Criterion C |
| Voltage sags             | SEMI F47 0200             |                        | 96Vac, 1000ms     | Criterion A |
|                          |                           |                        | 84Vac, 500ms      | Criterion A |
|                          |                           |                        | 60Vac, 200ms      | Criterion A |
| Input voltage swells     | RA internal standard      |                        | 300Vac, 500ms     | Criterion A |
| Powerful transients      | VDE 0160                  | over entire load range | 750V, 1.3ms       | Criterion A |

**Criteria:**

A: Power supply shows normal operation behavior within the defined limits.

C: Temporary loss of function is possible. Power supply might shut-down and restarts by itself. No damages or hazards for the power supply occur.

| EMC Emission                  | EN 61000-6-3 and EN 61000-6-4                       |          | Generic standards     |
|-------------------------------|---|----------|-----------------------|
| Conducted emission            | EN 55011, EN 55022, FCC Part 15, CISPR 11, CISPR 22 |          | Class B, input lines  |
|                               |   | EN 55022 | Class B, output lines |
| Radiated emission             | EN 55011, EN 55022                                  |          | Class B               |
| Harmonic input current        | EN 61000-3-2  |          | Fulfilled, active PFC |
| Voltage fluctuations, flicker | EN 61000-3-3  |          | Fulfilled             |

This device complies with FCC Part 15 rules.

Operation is subjected to following two conditions: (1) this device may not cause harmful interference, and (2) this device must accept any interference received, including interference that may cause undesired operation.

| Switching Frequencies | The power supply has three converters with three different switching frequencies included. Two are nearly constant. The other one is input voltage and load dependent. |                                  |
|-----------------------|--|----------------------------------|
| Switching frequency 1 | 110kHz   | nearly constant                  |
| Switching frequency 2 | 400kHz   | nearly constant                  |
| Switching frequency 3 | 65kHz to 280kHz  | input voltage and load dependent |

## 1606- XLSDNET4 24V, 3.8A; Single Phase Input

### 17. ENVIRONMENT

|                                 |  |  |
|---------------------------------|--|--|
| Operational temperature         | -25°C to +70°C (-13°F to 158°F)                                | reduce output power above +60°C                                      |
| Output de-rating                | 2W/°C  | +60 to +70°C (140°F to 158°F), see Fig. 17-1                         |
| Storage temperature             | -40 to +85°C (-40°F to 185°F)                                  | storage and transportation   |
| Humidity                        | 5 to 95% r.H.  | IEC 60068-2-30<br>Do not energize while condensation is present      |
| Vibration sinusoidal            | 2-17.8Hz: ±1.6mm;<br>17.8-500Hz: 2g<br>2 hours / axis          | IEC 60068-2-6  |
| Vibration random                | 0.5m <sup>2</sup> (s <sup>3</sup> )<br>2 hours / axis          | IEC 60068-2-64   |
| Shock                           | 30g 6ms, 20g 11ms<br>3 bumps / direction,<br>18 bumps in total | IEC 60068-2-27   |
| Altitude                        | 0 to 6000m (0 to 20 000ft)                                     | Reduce output power or ambient temperature<br>above 2000m sea level. |
| Output de-rating (for altitude) | 5W/1000m or 5°C/1000m  | above 2000m (6500ft), see Fig. 17-2                                  |
| Over-voltage category           | III<br>II  | EN 50178, altitudes up to 2000m<br>Altitudes from 2000m to 6000m     |
| Degree of pollution             | 2  | EN 50178, not conductive   |

Fig. 17-1 Output current vs. ambient temp.,

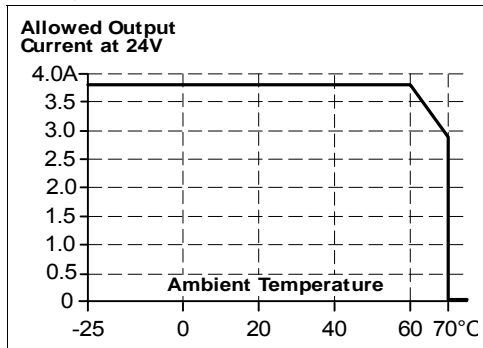
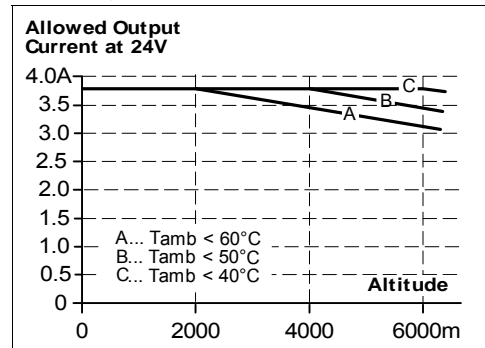

Fig. 17-2 Output current vs. altitude



The ambient temperature is defined as the air temperature 2cm below the unit.

## 1606- XLSDNET4 24V, 3.8A; Single Phase Input

### 18. PROTECTION FEATURES

|                                |   |   |
|--------------------------------|---|---|
| Output protection              | Electronically protected against overload, no-load and short-circuits |   |
| Output over-voltage protection | typ. 27Vdc<br>max. 29Vdc  | In case of an internal power supply defect, a redundant circuitry limits the maximum output voltage. The output shuts-down and automatically attempts to restart. |
| Output over-current protection | Electronically limited  | See <b>Error! Reference source not found.</b>   |
| Degree of protection           | IP 20   | EN/IEC 60529  |
| Penetration protection         | > 3.5mm   | e.g. screws, small parts  |
| Over-temperature protection    | yes   | output shut-down with automatic restart   |
| Input transient protection     | MOV (Metal Oxide Varistor) and active transient filter                |   |
| Internal input fuse            | T3.15A H.B.C.   | not user replaceable  |

Note: In case of a protection event, audible noise may occur.

### 19. SAFETY

|                                 |   |  |
|---------------------------------|---|--|
| Input / output separation       | SELV<br>PELV<br>double or reinforced insulation                               | IEC/EN 60950-1<br>EN 60204-1, EN 50178, IEC 60364-4-41   |
| Class of protection             | I   | PE (Protective Earth) connection required  |
| Isolation resistance            | > 5M $\Omega$   | input to output, 500Vdc  |
| PE resistance                   | < 0.1 $\Omega$  | between housing and PE terminal  |
| Touch current (leakage current) | typ. 0.11mA<br>typ. 0.16mA<br>typ. 0.27mA<br>< 0.14mA<br>< 0.22mA<br>< 0.40mA | 100Vac, 50Hz, TN mains<br>120Vac, 60Hz, TN mains<br>230Vac, 50Hz, TN mains<br>110Vac, 50Hz, TN mains<br>132Vac, 60Hz, TN mains<br>264Vac, 50Hz, TN mains |

### 20. DIELECTRIC STRENGTH

#### **⚠ WARNING**

To fulfill the PELV requirements according to EN60204-1 § 6.4.1, we recommend that either the + pole, the – pole or any other part of the output circuit shall be connected to the protective earth system. This helps to avoid situations in which a load starts unexpectedly or can not be switched off any more when unnoticed earth faults occur.

Fig. 20-1 Dielectric strength

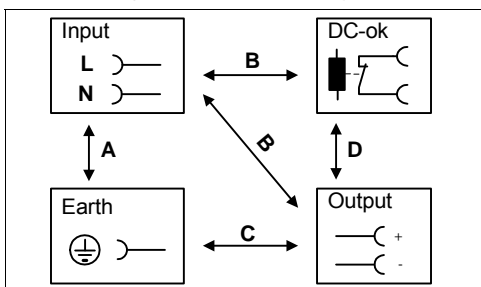

|              |     | A       | B       | C      | D      |
|--------------|-----|---------|---------|--------|--------|
| Type test    | 60s | 2500Vac | 3000Vac | 500Vac | 500Vac |
| Factory test | 5s  | 2500Vac | 2500Vac | 500Vac | 500Vac |
| Field test   | 5s  | 2000Vac | 2000Vac | 500Vac | 500Vac |

#### **Type tests and factory tests:**

Conducted by the manufacturer. Do not repeat test in field!





#### **Rules for field test:**

Use appropriate test equipment which applies the voltage with a slow ramp! Connect L and N together as well as all output poles.

# Rockwell Automation

## 1606- XLSDNET4 24V, 3.8A; Single Phase Input

### 21. APPROVALS

|   |   |   |
|---|---|---|
| IEC 60950-1   |    | CB Scheme,<br>Information Technology Equipment  |
| UL 508  |    | LISTED E198865 listed for use in U.S.A. (UL 508) and Canada (C22.2 No. 14-95)<br>Industrial Control Equipment   |
| UL 60950-1  |    | RECOGNIZED E137006 recognized for the use in U.S.A. (UL 60950-1) and Canada (C22.2 No. 60950)<br>Information Technology Equipment, Level 5  |
| UL 1604   |    | RECOGNIZED E246877 recognized for use in U.S.A. (UL 1604) and Canada (C22.2 No. 213-M1987)<br>Hazardous Location Class I Div 2 T4 Groups A,B,C,D and Class I Zone 2 Groups IIA, IIB and IIC |
| <p>The unit is suitable for use in Class I Division 2 Groups A, B, C, D locations as well as for Class I Zone 2 Groups IIA, IIB and IIC locations. Substitution of components may impair suitability for Class I Division 2 environment. Do not disconnect equipment unless power has been switched off. Wiring must be in accordance with Class I, Division 2 wiring methods of the National Electrical Code, NFPA 70, and in accordance with other local or national codes.</p> |   |   |
| SEMI F47  |  | SEMI F47-0200 Power Quality Star<br>Ride-through compliance for semiconductor industry.<br>Full SEMI range compliance (Input: 120Vac or 208Vac, output: 240W)                               |

### 22. FULFILLED STANDARDS

|                     |   |
|---------------------|---|
| EN 61558-2-17       | Safety of Power Transformers                |
| EN/IEC 60204-1      | Safety of Electrical Equipment of Machines  |
| EN/IEC 61131-2      | Programmable Controllers                    |
| EN 50178, IEC 62103 | Electronic Equipment in Power Installations |

### 23. USED SUBSTANCES

The unit does not release any silicone and is suitable for the use in paint shops.

Electrolytic capacitors included in this unit do not use electrolytes such as Quaternary Ammonium Salt Systems.

Plastic housings and other molded plastic materials are free of halogens, wires and cables are not PVC insulated.

The materials used in our production process do not include the following toxic chemicals:  
Polychlorinated Biphenyl (PCB), Pentachlorophenol (PCP), Polychlorinated naphthalene (PCN), Polybrominated Biphenyl (PBB), Polybrominated Biphenyl Oxide (PBO), Polybrominated Diphenyl Ether (PBDE), Polychlorinated Diphenyl Ether (PCDE), Polybrominated Diphenyl Oxide (PBDO), Cadmium, Asbestos, Mercury, Silica

## 1606- XLSDNET4 24V, 3.8A; Single Phase Input

### 24. PHYSICAL DIMENSIONS AND WEIGHT

|          |   |
|----------|---|
| Weight   | 620g / 1.37lb   |
| DIN-Rail | Use 35mm DIN-rails according to EN 60715 or EN 50022 with a height of 7.5 or 15mm. The DIN-rail height must be added to the depth (117mm) to calculate the total required installation depth. |

Fig. 24-1 Front view

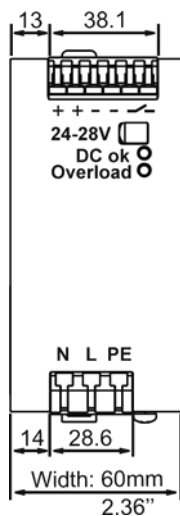
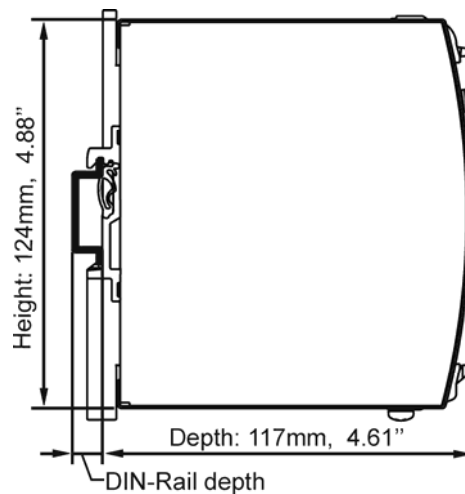

Fig. 24-2 Side view



### 25. INSTALLATION AND OPERATION INSTRUCTIONS

#### **⚠ WARNING**

**Hazardous voltage inside device. Risk of electric shock, severe burns, or death.**

- Do not use the unit without proper earth connection (Protective Earth). Use the pin on the terminal block for earth connection and not one of the screws on the housing.
- Turn power off before working on the power supply. Protect against inadvertent re-powering.
- Make sure the wiring is correct by following all local and national codes.
- Do not open, modify or repair the unit.
- Use caution to prevent any foreign objects from entering into the housing.
- Do not use in wet locations or in areas where moisture or condensation can be expected.

#### **Mounting:**

Output terminal must be located on top and input terminal on the bottom. For other orientations see section 27.9. An appropriate electrical and fire end-product enclosure needs to be considered in the end use application.

#### **Cooling:**

Convection cooled, no forced cooling required. Do not cover ventilation grid (e.g. cable conduits) by more than 30%!

#### **Installation clearances:**

40mm on top, 20mm on the bottom, 5mm on the left and right side are recommended when loaded permanently with full power. In case the adjacent device is a heat source, 15mm clearance is recommended.

#### **Service parts:**

The unit does not contain any serviceable parts. The tripping of an internal fuse is caused by an internal defect.

## 1606- XLSDNET4 24V, 3.8A; Single Phase Input

### 26. ACCESSORIES

#### 1606-XLB Wall mounting bracket

This bracket is used to mount Dimension units onto a flat surface without utilizing a DIN-Rail. The two aluminum brackets and the black plastic slider of the unit have to be detached, so that the two steel brackets can be mounted.

Fig. 26-1 1606-XLB Wall Mounting Bracket

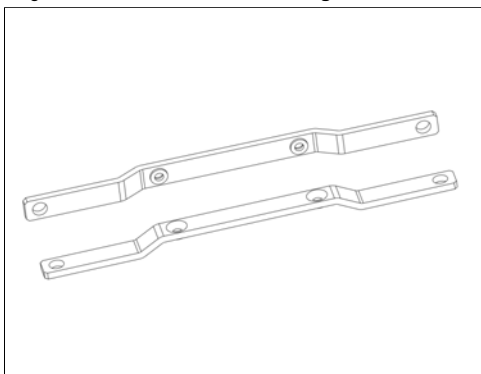
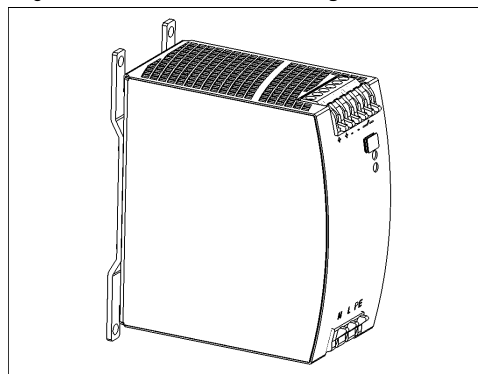

Fig. 26-2 Assembled Wall Mounting Bracket



## 1606- XLSDNET4 24V, 3.8A; Single Phase Input

### 27. APPLICATION NOTES

#### 27.1. PEAK CURRENT CAPABILITY

Solenoids, contactors and pneumatic modules often have a steady state coil and a pick-up coil. The inrush current demand of the pick-up coil is several times higher than the steady state current and usually exceeds the nominal output current (including the Power-Boost) The same situation applies, when starting a capacitive load.

Branch circuits are often protected with circuit breakers or fuses. In case of a short or an overload in the branch circuit, the fuse needs a certain amount of over-current to trip or to blow. The peak current capability ensures the safe operation of subsequent circuit breakers.

Assuming the input voltage is turned on before such an event, the built-in large sized output capacitors inside the power supply can deliver extra current. Discharging this capacitor causes a voltage dip on the output. The following two examples show typical voltage dips:

Fig. 27-1 Peak load 7.6A for 50ms, typ.

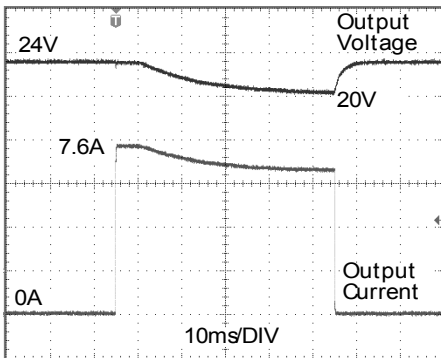

Peak load 7.6A (resistive) for 50ms  
Output voltage dips from 24V to 20V.

Fig. 27-2 Peak load 15A for 5ms, typ.

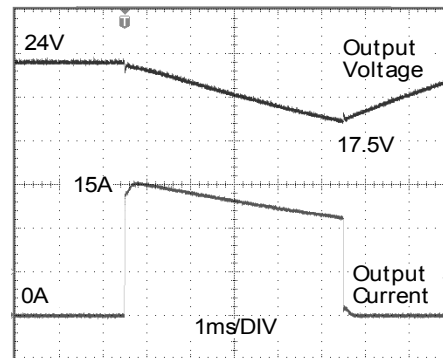

Peak load 15A (resistive) for 5ms  
Output voltage dips from 24V to 17.5V.

Please note: The DC-OK relay triggers when the voltage dips more than 10% for longer than 1ms.

#### 27.2. BACK-FEEDING LOADS

Loads such as decelerating motors and inductors can feed voltage back to the power supply. This feature is also called return voltage immunity or resistance against Back- E.M.F. (Electro Magnetic Force).

This power supply is resistant and does not show malfunctioning when a load feeds back voltage to the power supply. It does not matter, whether the power supply is on or off.

The maximum allowed feed back voltage is 28Vdc. The absorbing energy can be calculated according to the built-in large sized output capacitor which is specified in chapter 8.

#### 27.3. PARALLEL AND SERIAL USE

Do not use the 1606-XLSDNET4 power supplies in parallel to increase the output power or in series for a higher output voltage. The NEC Class 2 requirements in the system will be violated if such power supplies are used in parallel. If higher power is needed choose 1606-XLSDNET8. However, power supplies can be used in parallel to build redundant systems.



## 1606- XLSDNET4 24V, 3.8A; Single Phase Input

### 27.4. OUTPUT CIRCUIT BREAKERS

Standard miniature circuit breakers (MCBs) can be used for branch protection. Ensure that the MCB is rated for DC voltage, too. The following tests show which circuit breakers the power supply typically trips.

Circuit breakers have huge tolerances in their tripping behavior. Therefore, these typical tests can only be used as a recommendation or for comparing two different power supplies. Furthermore, the loop impedance has a major influence on whether a breaker trips or not. Two tests were performed, representing typical situations:

**Test 1:** Short circuit with S1 on the power supply end of the cable (loop impedance approx. 20mOhm)

Fig. 27-3 Branch protectors, test circuit 1

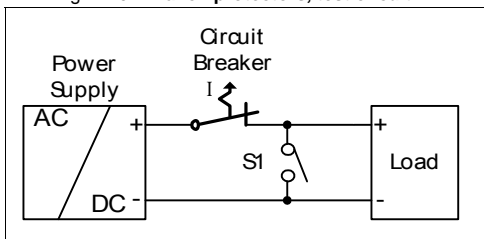

Parameters:

Input voltage: 230Vac, load current: 0A  
 Tripping time shorter than 5s.

The following circuit breaker tripped during the test:

- A- or Z- Characteristic: equal or smaller 10A
- B- Characteristic: equal or smaller 6A
- C- Characteristic: equal or smaller 3A

**Test 2:** Short circuit with S1 on the load end (additional impedance included; represents longer load wire length).

Fig. 27-4 Branch protectors, test circuit 2

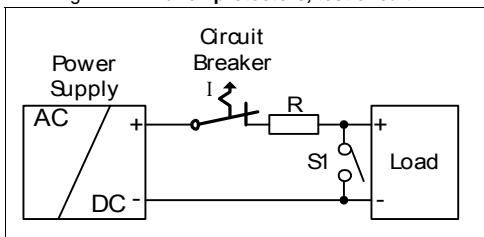

Parameters:

Input voltage: 230Vac, load current: 0A  
 Tripping time shorter than 5s.

The following circuit breaker tripped during the test:

- A- or Z- Characteristic: ≤ 6A and R < 180mOhm
- C- Characteristic: ≤ 2A and R < 270mOhm

What does this resistance mean in wire length?

|         | 0.5mm <sup>2</sup> | 0.7mm <sup>2</sup> | 1.0mm <sup>2</sup> | 1.5mm <sup>2</sup> | 2.5mm <sup>2</sup> | 4.0mm <sup>2</sup> |
|---------|--------------------|--------------------|--------------------|--------------------|--------------------|--------------------|
| 180mOhm | 5.0m               | 7.0m               | 10.0m              | 15.0m              | 25.1m              | 40.1m              |
| 270mOhm | 7.5m               | 10.5m              | 15.0m              | 22.6m              | 37.6m              | 60.2m              |

**Example:**

Which wire gauge must be used to trip a C-Characteristic circuit breaker with a rating of 2A? The load wire length is 21m.

Answer: A 2A C-Characteristic circuit breaker requires a loop impedance of less than 270mOhm (test results). The wire length table shows that up to 22.6m wire with a cross section of 1.5mm<sup>2</sup> are below 270mOhm. A wire not smaller than 1.5mm<sup>2</sup> shall be used.

### 27.5. EXTERNAL INPUT PROTECTION

The unit is tested and approved for branch circuits up to 20A. External protection is only required, if the supplying branch has an ampacity greater than this. In some countries local regulations might apply. Check also local codes and local requirements.

If an external fuse is necessary or utilized, a minimum value is required to avoid undesired tripping of the fuse.

|          |      | B-Characteristic | C-Characteristic |
|----------|------|------------------|------------------|
| Ampacity | max. | 20A              | 20A              |
|          | min. | 6A               | 3A               |

## 1606- XLSDNET4 24V, 3.8A; Single Phase Input

### 27.6. INDUCTIVE AND CAPACITIVE LOADS

The unit is designed to supply any kind of load, including unlimited capacitive and inductive loads.

### 27.7. OPERATION ON TWO PHASES

Fig. 27-5 Schematic for two phase operation

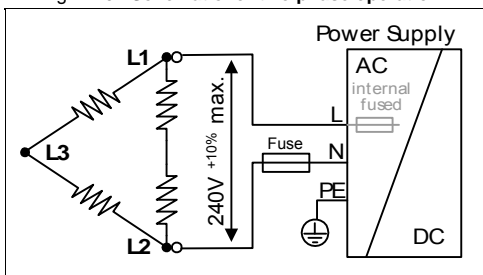

#### Instructions for two phase operation:

- A phase to phase connection is allowed as long as the supplying voltage is below 240V(10%).
- Use a fuse or a circuit breaker to protect the N input. The N input is internally not protected and is in this case connected to a hot wire.

Appropriate fuses or circuit breakers are specified in section 27.3 "External Input Protection".

### 27.8. USE IN A TIGHTLY SEALED ENCLOSURE

When the power supply is installed in a tightly sealed enclosure, the temperature inside the enclosure will be higher than outside. The inside temperature defines the ambient temperature for the power supply.

Results from such an installation:

Power supply is placed in the middle of the box, no other heat producer inside the box

Enclosure: Typ IP66 Box PK 9516 100, plastic, 110x180x165mm

Load: 24V, 3.8A; (=80%) load is placed outside the box

Input: 230Vac

Temperature inside enclosure: 42.3°C (in the middle of the right side of the power supply with a distance of 2cm)

Temperature outside enclosure: 23.3°C

Temperature rise: 19.0 °C

## 1606- XLSDNET4 24V, 3.8A; Single Phase Input

### 27.9. MOUNTING ORIENTATIONS

Mounting orientations other than input terminals on the bottom and output on the top require a reduction in continuous output power or a limitation in the max. allowed ambient temperature. The amount of reduction influences the lifetime expectancy of the power supply. Therefore, two different derating curves for continuous operation can be found below:

**Curve A1** Recommended output current.

**Curve A2** Max allowed output current (results approx. in half the lifetime expectancy of A1).

Fig. 27-6 Mounting Orientation A  
Standard Orientation

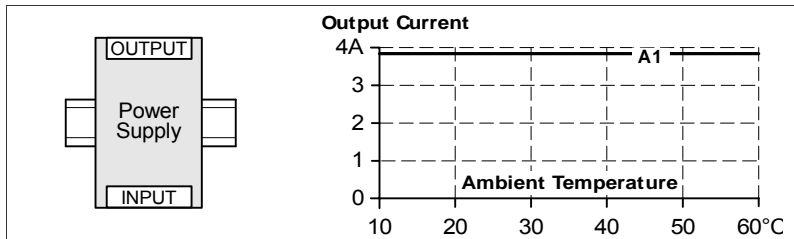

Fig. 27-7 Mounting Orientation B  
(Upside down)

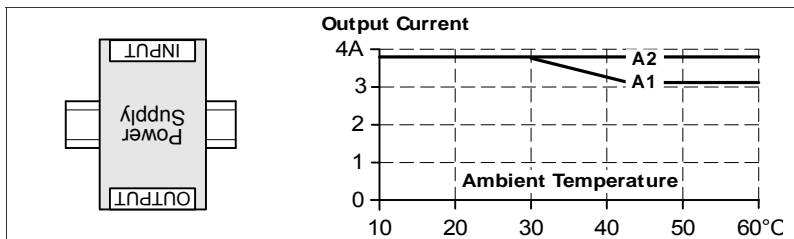

Fig. 27-8 Mounting Orientation C  
(Table-top mounting)

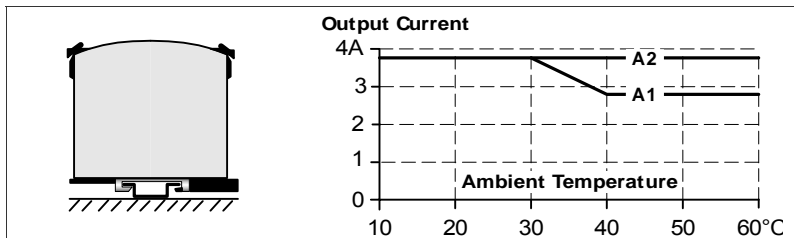

Fig. 27-9 Mounting Orientation D  
(Horizontal cw)

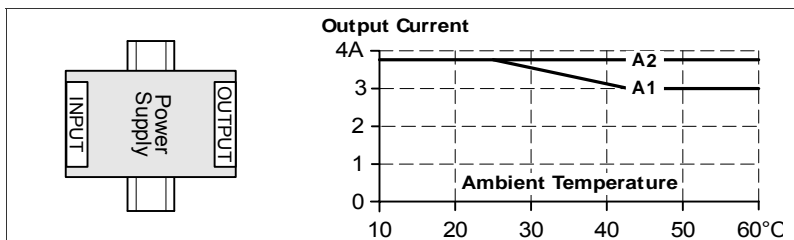

Fig. 27-10 Mounting Orientation E  
(Horizontal ccw)

