



Allen-Bradley

**Bulletin 1201
Graphic
Programming
Terminal**

Version 3.xx

User Manual

Introduction**Chapter 1**

Chapter Objectives	1-1
GPT Description	1-1
Display Features	1-2
Keypad Description	1-3
Key Descriptions	1-4
Optional Run Time Keys	1-6
GPT Operation	1-6
GPT Menu Tree	1-8

Parameter Option**Chapter 2**

General	2-1
Accessing the Linear Parameter Mode	2-2
Accessing a Parameter in the Linear Mode	2-3
Changing a Parameter Value	2-4
Saving Parameter Values	2-5
Accessing the File/Group/Element Mode	2-6
File Selection in FGE Mode	2-6
Group Selection in FGE Mode	2-8
Element Selection in FGE Mode	2-8
Changing Value Base	2-9
Exiting the FGE Mode	2-10
Returning to the Linear Mode	2-10

Fault & Warning Queues**Chapter 3**

Introduction	3-1
Accessing the Fault Queue	3-1
Clearing Faults	3-2
Accessing the Warning Queue	3-4
Clearing Warnings	3-5

EE/BRAM Functions**Chapter 4**

General	4-1
Accessing the EE/BRAM Function	4-1
Saving Parameters to EE	4-2
Recalling EE Parameters	4-2
Saving Factory Defaults to RAM	4-3

Link Summary	Chapter 5	
	General	5-1
	Accessing the Link Summary	5-1
	Searching for Linked Parameters	5-2
	Changing or Adding Parameter Links	5-3
	Saving Parameter Links	5-4
	Clearing All Links in the System	5-4
Clock Data	Chapter 6	
	General	6-1
	Accessing the Clock Data Function	6-1
	Setting the Clock	6-2
	Setting the Reference	6-3
	Loading the Reference	6-4
	Zeroing the RT Accumulator	6-4
Process Display	Chapter 7	
	General	7-1
	Accessing the Process Display	7-1
	Accessing the Drive Status Mode	7-2
	Accessing the Metering Mode	7-3
	Accessing the Configuration Mode	7-4
	Disabling a Process Display Variable	7-4
	Recalling a Process Display Variable	7-5
	Programming a Configurable Variable	7-5
	Changing Parameter Numbers	7-5
	Changing the Configuration Text	7-6
Special Menu	Chapter 8	
	General	8-1
	Accessing the Special Menu Function	8-1
	Changing & Entering a Password	8-2
	Inspecting Version Information	8-4
	Changing Drive Identity	8-5
	Changing Drive Identity in Hex	8-7
	Accessing the Data Transfer Function	8-8
	Uploading	8-8
	Downloading	8-9

Introduction

Chapter Objectives

Chapter 1 describes the various controls and indicators found on the optional Graphics Programming Terminal (1201 GPT). The GPT is an enhanced control that provides a means of programming, viewing operating parameters, on-line troubleshooting and analyzing of all SCANbus™ products.

GPT Description

When an optional GPT (Figure 1.1) is supplied, it will be either mounted to the front of a Drive as a panel mount terminal or supplied as a remote device with a 1.8 meter (6 foot) long cable. The GPT offers a 40 by 8 character display that can also be used as a graphics display to show bartype graphs, etc.

Figure 1.1
1201 Graphics Programming Terminal

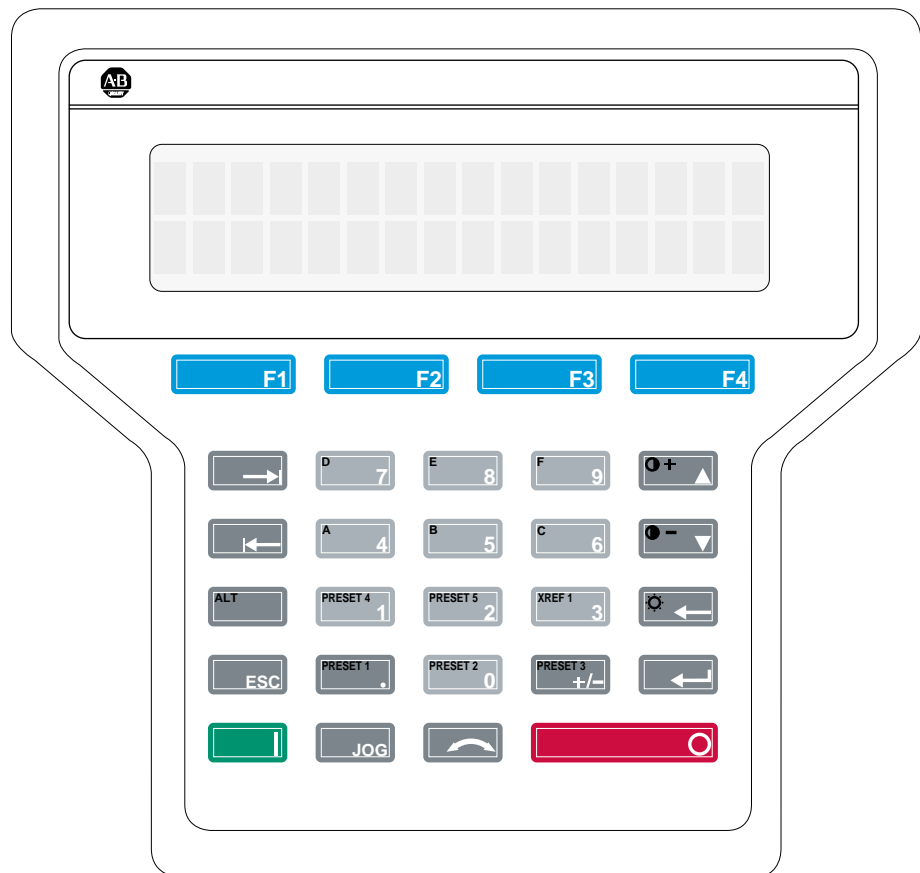

NOTE: This manual shows examples based on a 1336 FORCE™ Drive using a PLC Comm Adapter Board. On other SCANbus products or 1336T drives equipped with other adapter boards, some options may not be active or displays may vary slightly from the examples shown here.

Display Features

Four different interface boxes (Figure 1.2) appear on the GPT display to provide you with pertinent information. These boxes include:

Help Box: This box provides help information related to the function being currently displayed. The **Help Box** will provide you with information on what can be accessed or programmed using this specific menu function.

Info Box: This box provides you with information about the data currently on the screen. This information typically includes minimum or maximum values, operation modes, and data references. If the data being displayed is a parameter value, the **Info Box** will provide the min, max, linear number and base type (Engr, Hex, Octal, Signed/Unsigned Decimal) of the data.

Status Bar: This box provides you with status information about processes within the Drive or Terminal. Information such as the present Drive condition (speed, mode, state) or Processing Status (such as percent of uploading or downloading completed) are typical displays.

Fault Annunciation Box: When a fault occurs, this box will supply you information such as the fault code and fault text string. This box will be annunciated on the screen for three seconds or until you acknowledge the condition by pressing the ESCape key.

Figure 1.2
Display Screen Components

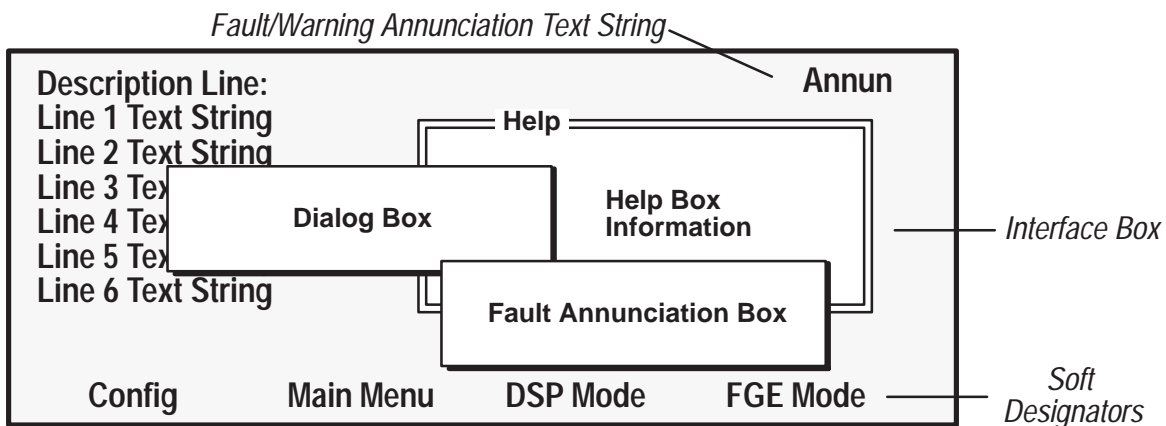

Information Box: Under some conditions, when immediate USER interaction is required a fifth **Dialog or Fault Annunciation Box** (Figure 1.3) will appear. These boxes will appear on top of all other information when an immediate USER response to an error condition, command verification or data input is required.



Figure 1.3
Information Boxes







Cursor Types: In most cases carets (< >) are used to indicate selected functions and the data entry area. In some cases a \$ sign or # sign may be

used to indicate the selected letter or numeral in a text string.

Soft Key Designators: Four soft designators are located at the bottom of the Display screen (SWFunc1, SWFunc2, SWFunc3, SWFunc4). These soft designators (Figure 1.2) are tied to the F1 thru F4 keys on the Graphics Programming Terminal (Figure 1.4). Various selection options will appear on the screen at the F1 thru F4 positions. These options are typically answers to screen prompts, (Yes/No, Save/Don't Save, Load/Clear etc.).

Backlight: The GPT terminal provides a backlight option which can be used for better visibility in low light conditions. To activate the backlight press the ALternate key  and then the DELete key .

Contrast: The GPT terminal provides an adjustment for increased/decreased contrast ratio to compensate for temperature and visual angle consideration. To increase contrast press the ALternate key  and then hold down the Increment key . To decrease the contrast press the ALternate key  and then hold down the DECrement  key.







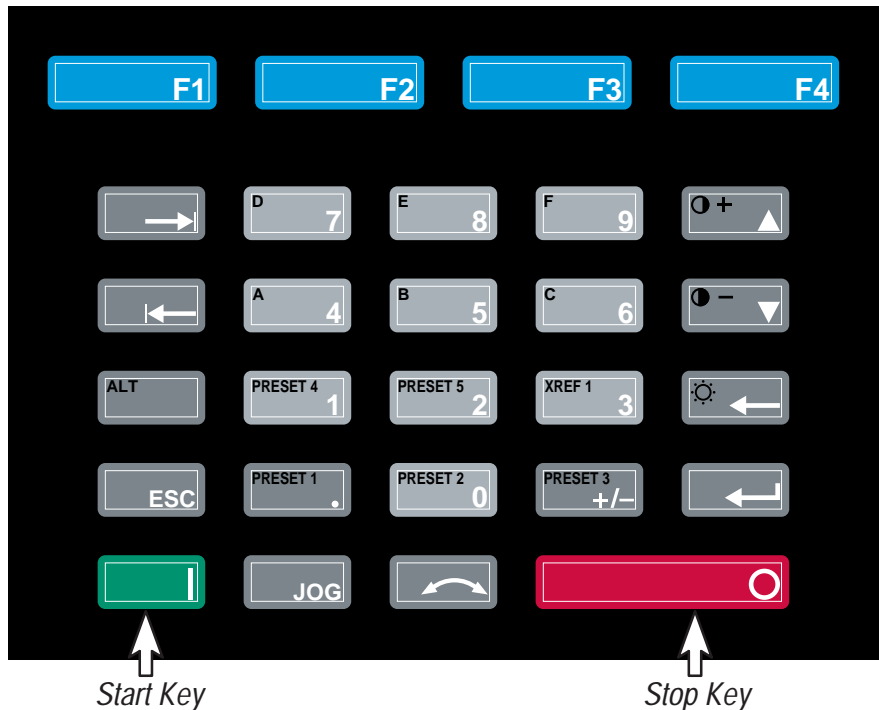





Keypad Description

The GPT keyboard (Figure 1.4) is provided as either a 24 key version (non-runtime) or 28 key (runtime version). The runtime version as shown in Figure 1.4 provides additional Start, Stop, Jog and Direction keys.

Figure 1.4
GPT Keypad



Key Descriptions

	ESCape When pressed, this key will cause the current function to be aborted and will return you to the previous menu screen. In the case of a dialog box, only the dialog entry will be aborted.
	ALTername When pressed, this key selects the secondary key functions for keys with ALTername functions such as the Num/Preset keys. Alternate functions are always identified in (color) at the upper left of a key.
	INC/DEC These keys allow you to to increment or decrement a value, or scroll through different groups or parameters. When used in conjunction with the ALTername key, the screen contrast can be adjusted up or down.
	
	ENTer When pressed, this key executes the selected function.
	DELeTe When pressed, this key deletes the last key stroke entry. This key is also used in conjunction with the ALTername key to toggle the backlight.
	NEXT When pressed, this key allows field to field cursor movement.
	PREVious When pressed, this key allows reverse field movement.
	Dec Pt/Preset 1 This key allows you to enter a decimal point or to select Preset 1 when used in conjunction with the ALTername key. (ALT function on Runtime Version only).
	Num 0/Preset 2 This key allows you to enter the number zero or to select Preset 2 when used in conjunction with the ALTername key. (ALT function on Runtime Version only).
	Sign/Preset 3 This key allows signed entry of data or it allows you to select Preset 3 when used in conjunction with the ALTername key. (ALT function on Runtime Version only).
	Num 1/Preset 4 This key allows you to enter the number 1 or to select Preset 4 when used in conjunction with the ALTername key. (ALT function on Runtime Version only).
	Num 2/Preset 5 This key allows you to enter the number 2 or to select Preset 5 when used in conjunction with the ALTername key. (ALT function on Runtime Version only).



Numeric 3/Xref

This key allows you to enter the number 3 or to select XREF 1 when used in conjunction with the ALternate key. (ALT function on Runtime Version only).



Numeric 4/A

This key allows you to enter the number 4 or to enter the letter A when used in conjunction with the ALternate key.



Numeric 5/B

This key allows you to enter the number 5 or to enter the letter B when used in conjunction with the ALternate key.



Numeric 6/C

This key allows you to enter the number 6 or to enter the letter C when used in conjunction with the ALternate key.



Numeric 7/D

This key allows you to enter the number 7 or to enter the letter D when used in conjunction with the ALternate key.



Numeric 8/E

This key allows you to enter the number 8 or to enter the letter E when used in conjunction with the ALternate key.



Numeric 9/F

This key allows you to enter the number 9 or to enter the letter F when used in conjunction with the ALternate key.



F1 SW Key

This key will change meaning for each screen, as it is programmable by the terminal firmware.



F2 SW Key

This key will change meaning for each screen, as it is programmable by the terminal firmware.



F3 SW Key

This key will change meaning for each screen, as it is programmable by the terminal firmware.



F4 SW Key

This key will change meaning for each screen, as it is programmable by the terminal firmware.

Optional Run Time Keys



START

The Start key will initiate drive operation if no other control devices are sending a Stop command.



STOP

If the drive is running, pressing the Stop key will cause the drive to stop, using the selected stop mode. Refer to the Drive user manual. If the drive has stopped due to a fault, pressing this key will clear the fault and reset the drive.



JOG

When pressed, jog will be initiated if no other control devices are sending a stop command. Releasing the key will cause the drive to stop, using the selected stop mode. Refer to the Drive user manual.



DIR

Pressing this key will cause the drive to ramp down to zero speed and then ramp up to set speed in the opposite direction. Refer to the Drive user manual.

GPT Operation

When power is first applied to the drive or device, a series of hardware diagnostic tests will run before the Power Up Logo Screen shown in Figure 1.5 appears. Once the initialization has been completed and all information from the drive is uploaded, the terminal will display either the Main Menu screen or the Process Display screen depending on the terminal setup information.

Figure 1.5
GPT Power Up Logo Screen

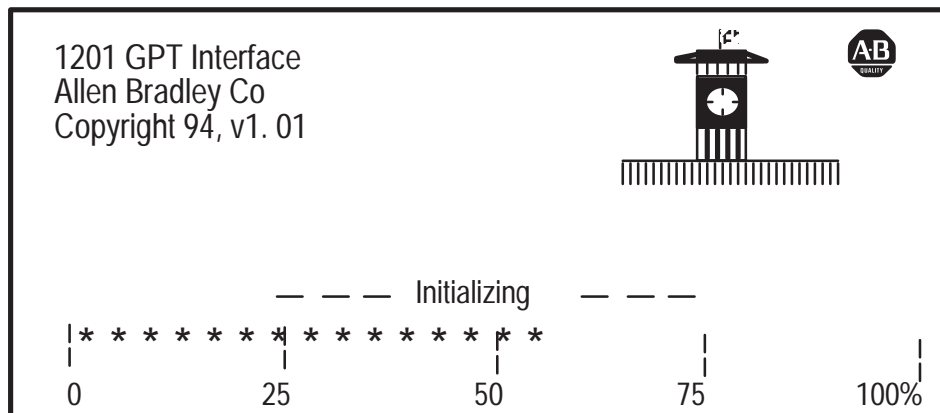

If it has not been deactivated through the terminal during setup, the Process Display Screen (Figure 1.6) showing you the programmed process variables will appear next. If the Process Display Screen is deactivated, the Main Menu Screen (Figure 1.7) will appear first.

In the case of a 1336 FORCE Drive equipped with a PLC Comm Adapter Board, eight menu options will be available as shown in Figure 1.7. When the Process Display Screen is active, it is necessary to press the Main Menu Option (F2 soft designator) on the Process Display to reach the Main Menu. The Main Menu contains the password option that provides a highlighted dialog box for password entry.

The Configuration option (F1 soft designator) allows you to directly access Process parameters from the Process Display screen. The Display Mode option (F3 soft designator) allows you to enter the Logo, Status or Meter modes for the Process Display parameters.

Figure 1.6
Process Display Screen

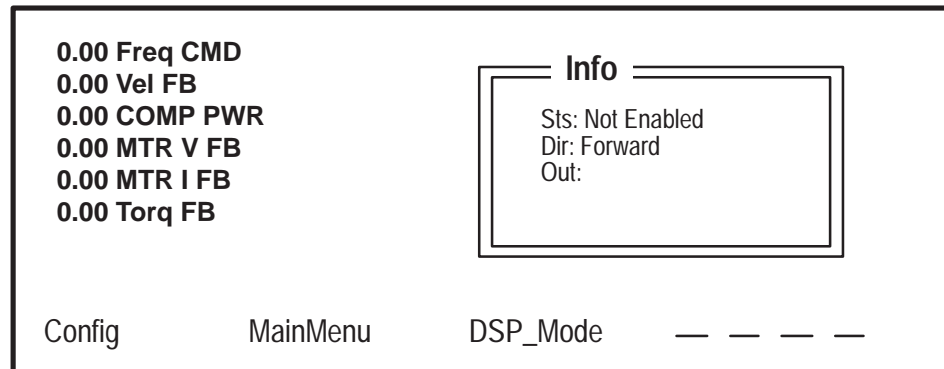

IMPORTANT: Main Menu screens are dynamic and will change based on functionality provided by adapter and drive status.

Figure 1.7
Main Menu Screen

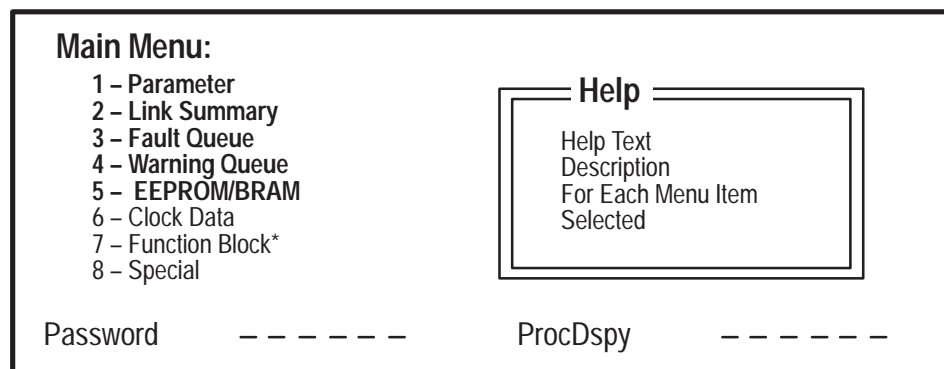

IMPORTANT: Only 5 of the 8 Main Menu options are displayed at one time on the screen. Scroll with the Inc/Dec keys to access all eight selections.

* *Currently not implemented*

Figure 1.8 details the complete menu tree for the GPT Programming Terminal. This menu is dynamic and all options may not be supported by your Drive or SCANbus device. If you need more detailed information on Key functions, Menu Screens or general Terminal operation refer to the appropriate chapter in this manual.

Figure 1.8
GPT Programming Options

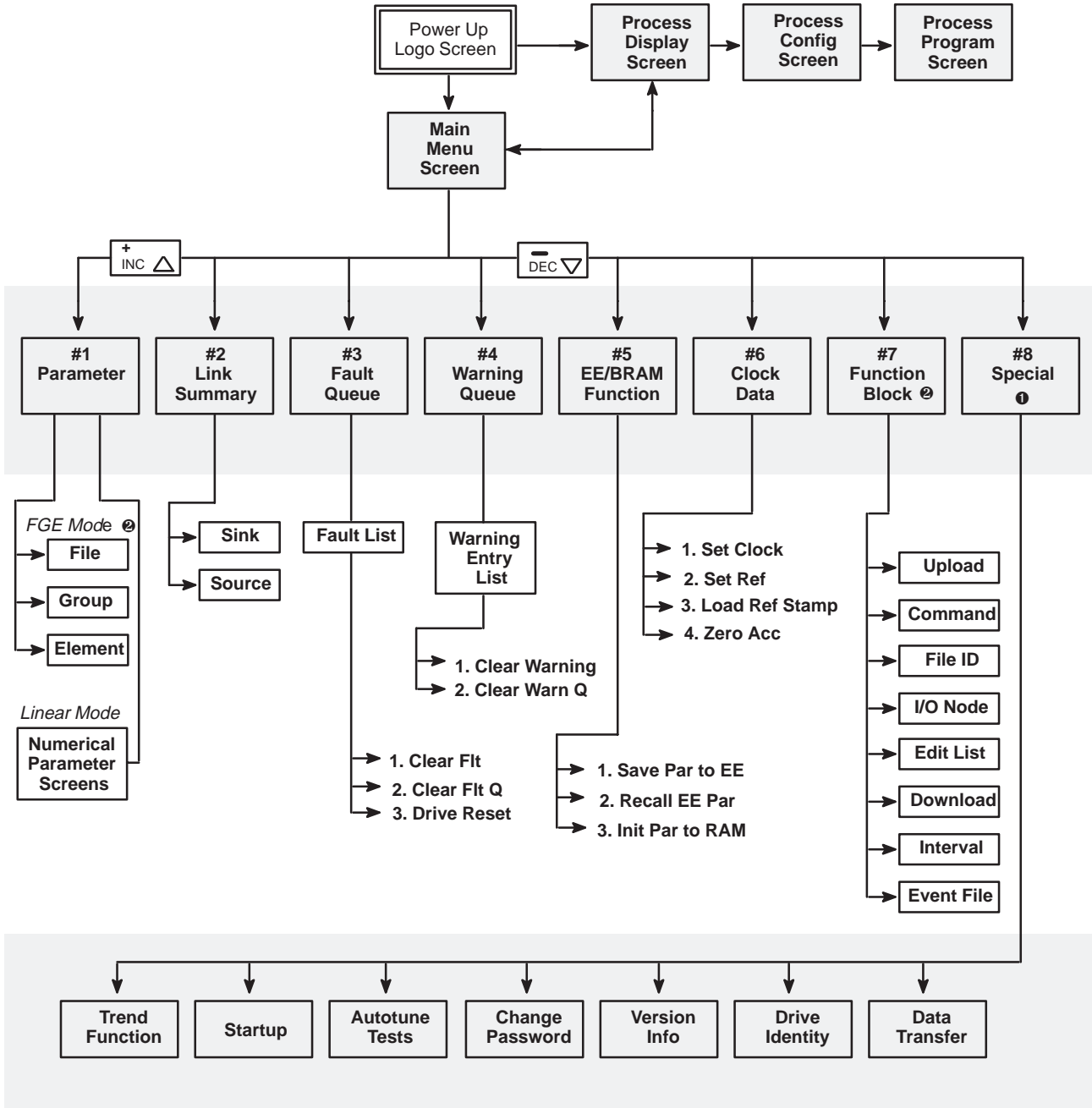

❶ This list is dynamic and will change for various Drive States and Drive Product functions.
 ❷ Currently not implemented.

>



Parameter Option

General

The Parameter Option provides you with access to the Drive parameter database. Any parameter can be directly accessed by number in the Linear Mode as shown in Figure 2.1, or any parameter can be viewed by File, Group or Element as shown in Figure 2.2. The Element option is accessed by pressing the Return key while the initial File/Group display is active.

Figure 2.1
(Linear Mode Initial Screen)

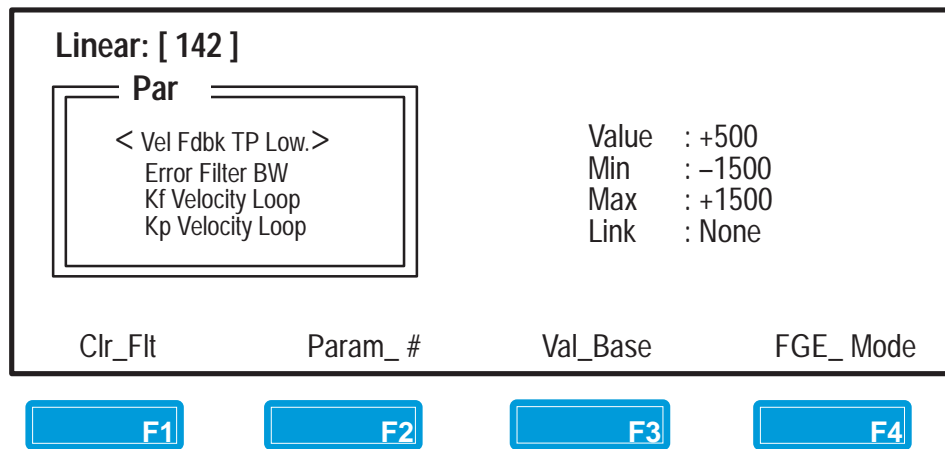
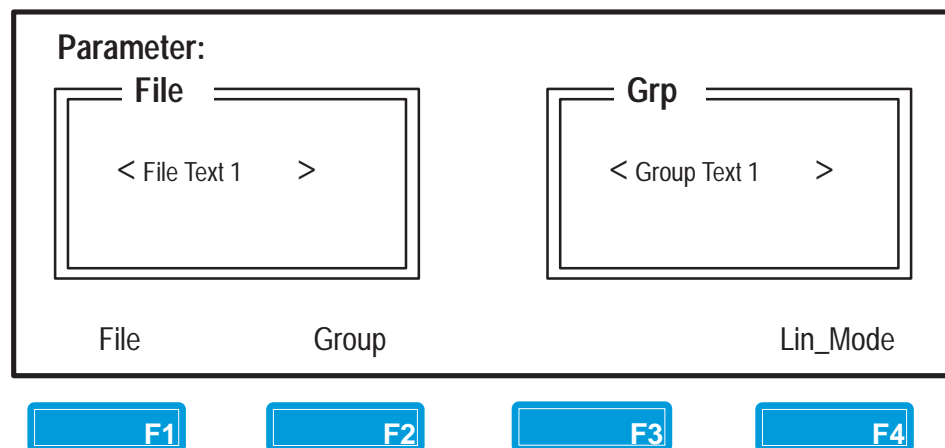

Figure 2.2
(File/Group/Element Mode Initial Screen)



Accessing the Linear Parameter Mode

To access the Linear Parameter Mode from the Main Menu (Figure 2.3),





press the Increment  or Decrement  key to move the cursor to selection #1 “Parameter”.

Figure 2.3
Main Menu

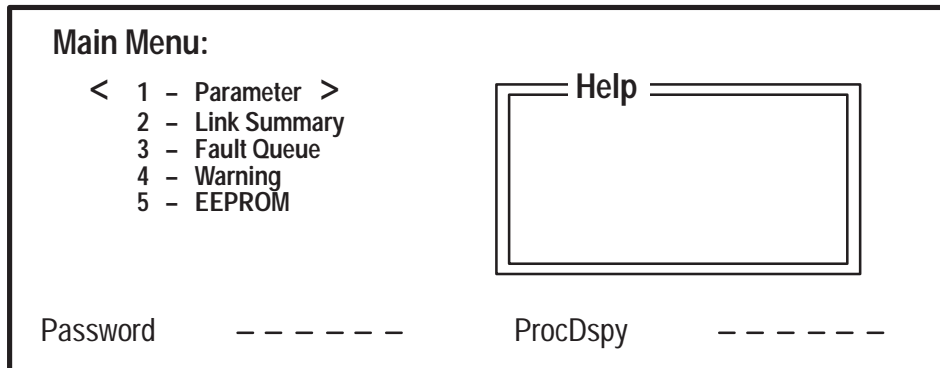

Press the Enter Key , the terminal will go into either

File/Group/Element or Linear Mode, depending on which mode was last used. The initial default on startup is the FGE mode. If the FGE Mode appears first, press the  soft designator and the Linear

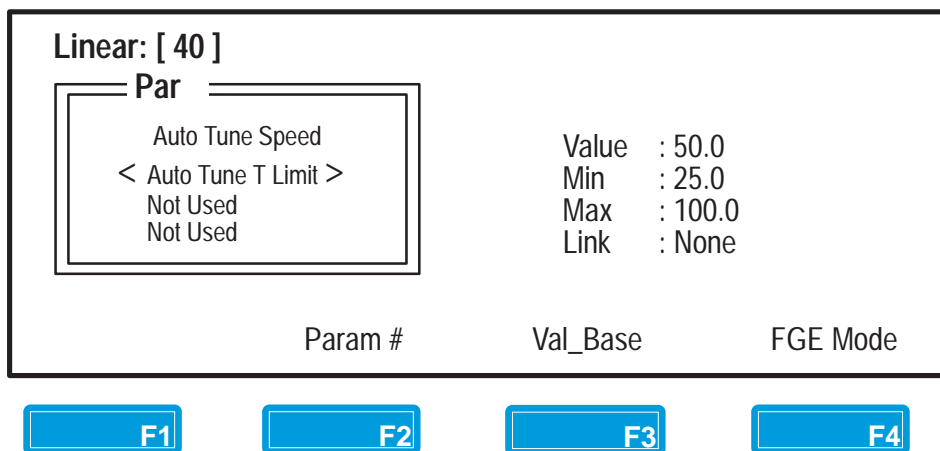

Parameter Mode will appear, showing the current parameter value, minimum and maximum values and any links that are present (Fig. 2.4).

Figure 2.4
Linear Parameter Mode



Accessing a Parameter in the Linear Mode

With the Linear Parameter Screen (Figure 2.5) displayed, perform the following steps:

Step 1 Use the  or  key to scroll through the parameter numbers; or

Step 2 If you wish to enter a parameter number directly, press the  soft designator key. The dialog box shown in Figure 2.5 will appear.

Figure 2.5

Linear Direct Access Screen





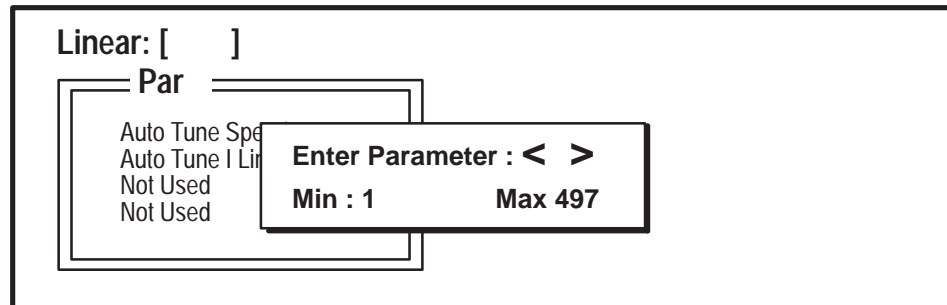



Step 3 Use the numerical keys   &   to enter a parameter number within the cursors (Figure 2.6).

Figure 2.6

Parameter Number Entry

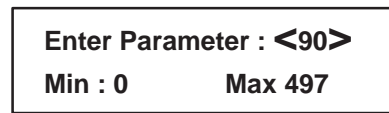

Press  to enter your selected Linear Parameter number. The information on your selected parameter (90 in this case) will appear as shown in Figure 2.7.

If you press  without entering a parameter number (no digits), the display will return to the previous parameter. Toggling between 2 parameters is allowed (Present & Previous).

Figure 2.7

Linear Parameter Number Screen

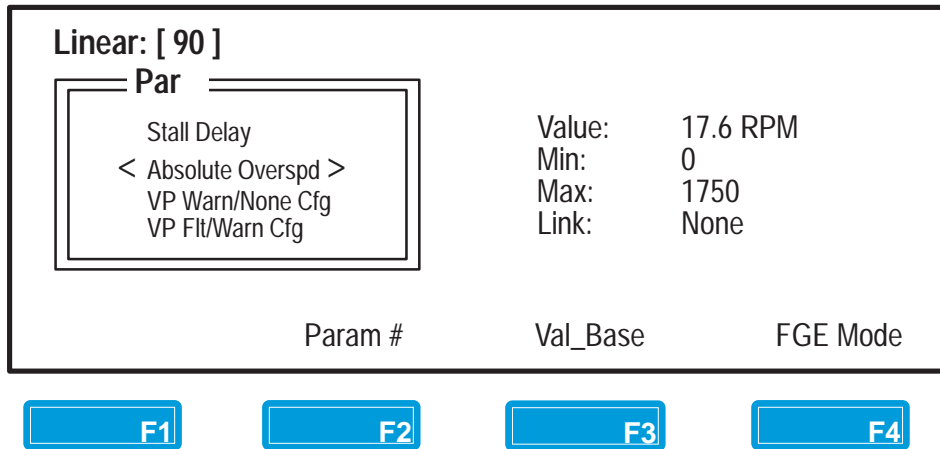

Changing a Parameter Value

Move to the Value area of the screen by pressing the  selection Key. The cursor will move to the current value in RPM.

Figure 2.8

Linear Parameter Value Screen



IMPORTANT: In some cases you may find it is not possible to change the value of a parameter. In cases where a parameter is being used as a source or a link, you will be blocked from making any value changes.

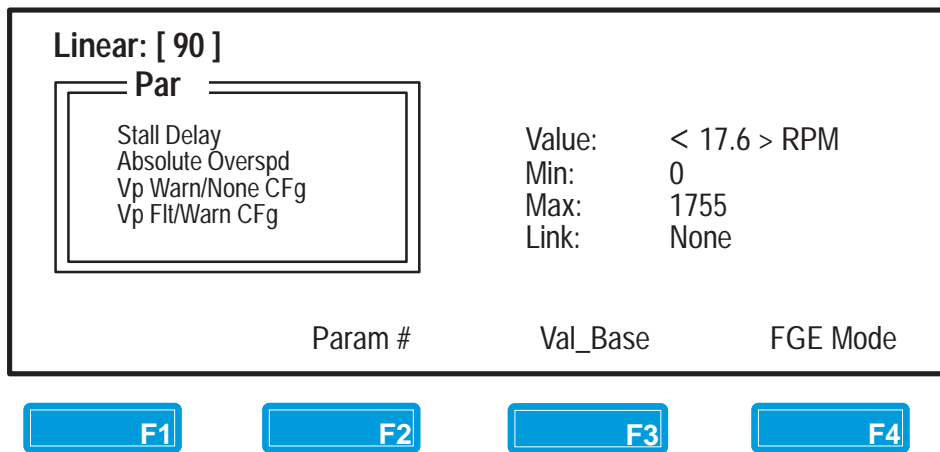

Use the  or  keys to change the value (Figure 2.9) or enter the value directly with the numeric keys.

Figure 2.9
Parameter Value Change



Saving Parameter Values

To save your new value in RAM, press the  key.

IMPORTANT: This is only necessary when a value is entered directly with the numeric keys. If the INC and DEC keys were used to enter the value, the value is automatically stored in RAM (Drive).

To store your new value to BRAM, press the  key. A message will appear (Figure 2.10), asking if you wish to save the parameter.

Figure 2.10
Parameter Change Verification



To save the new value, press  . To leave the parameter at the previous value, press  .

IMPORTANT: If you are making more than one parameter change, it is not necessary to save every new parameter value at the time you make a value change. All parameter changes can be saved at one time using the EE/BRAM option detailed in Chapter 4.

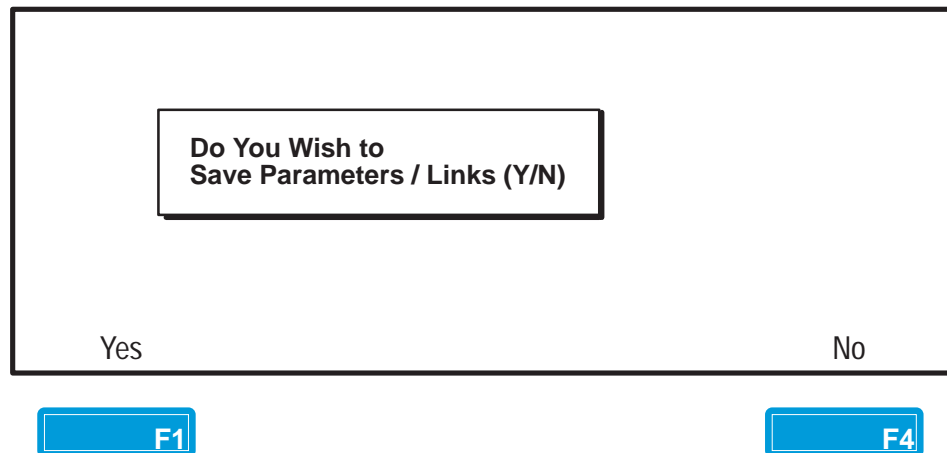
Accessing the FGE Mode

In addition to accessing parameters one-by-one in the Linear Parameter mode, it is also possible to access parameters that have been grouped in special Files. The number of Files will vary depending on what type of Drive or Device you are using with the GPT, and how the Drive or Device is configured. For Example; a 1336 FORCE Drive equipped with a PLC Communication Adapter Board would have all parameters broken down into four files which include:

1. Startup File
2. Communication IO File
3. Velocity Torque File
4. Diagnostics File

If you are in the Linear Parameter Mode, press the  soft designator key to reach the File/Group/Element Mode (Fig. 2-11).

Figure 2.11
File/Group/Element Initial Screen



File Selection



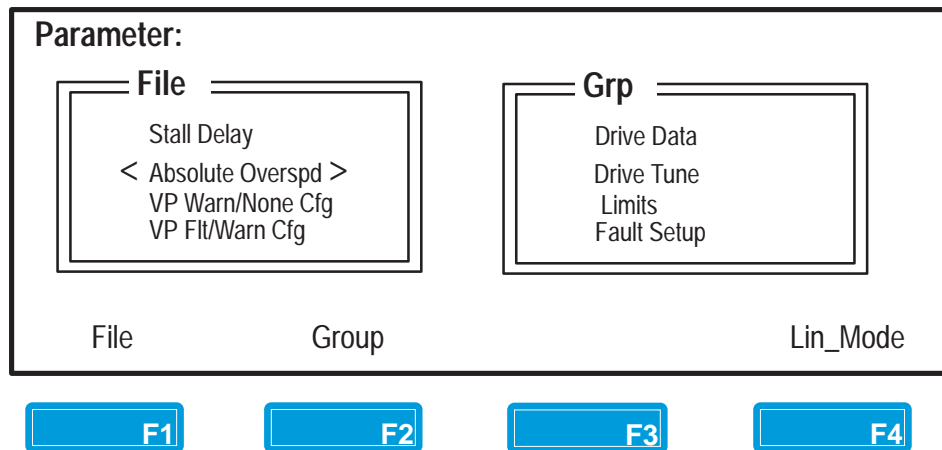

To access the File options, press the  soft designator key. The four available File choices will appear as in Figure 2.12.

Figure 2.12
File Selection

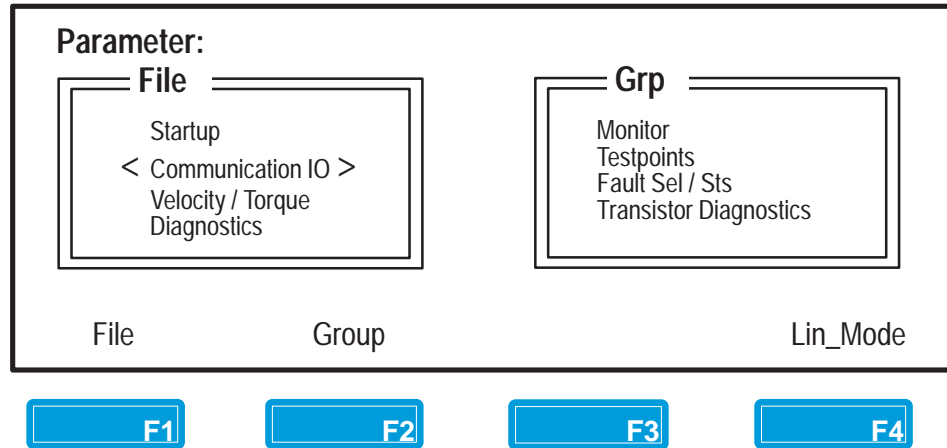

Use the  or  keys to place the cursors on your File choice and press the  key.

In the example in Figure 2.13 you are in the Communication IO File and the Group options are available on the right hand side of the display.

Figure 2.13
Group Selection

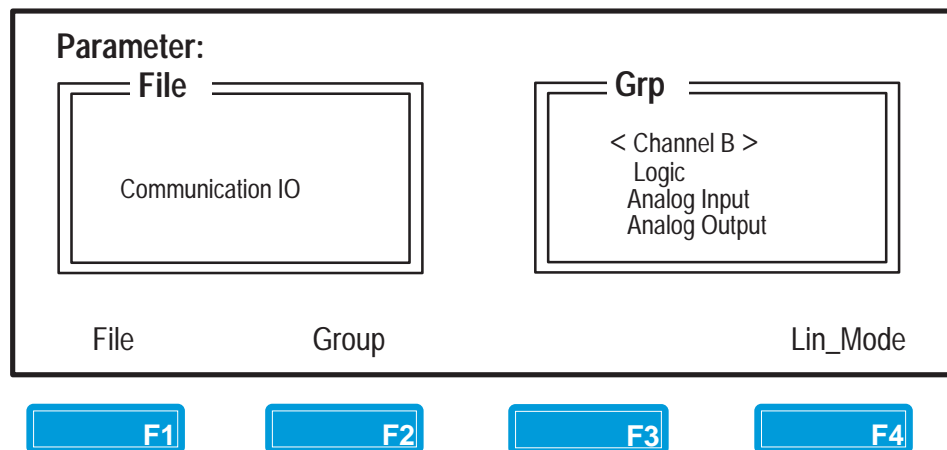

Group Selection

When you selected your File option, the cursors automatically moved to the Group window on the right side of the Display.

Use the  or  keys to scroll to your desired Group selection.



Element Selection

Press the  key to access the elements for this group (Figure 2.14).

Press  to return to the Group menu.

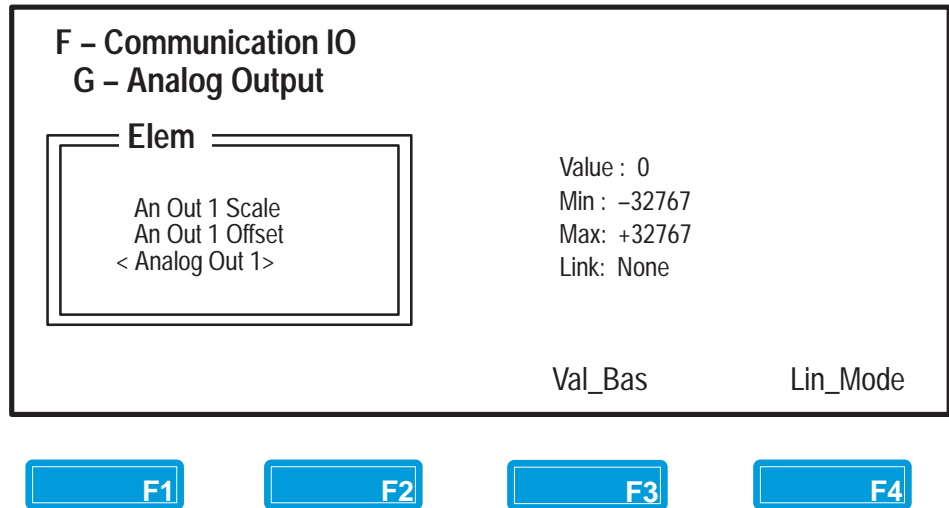
Figure 2.14
Element Selection



The first element under the Analog Output Group, Analog Output 1, is shown within the cursors in Figure 2.15. To access the other elements in the group, use the  or  keys to scroll thru the list.

To change values for this element, press the  key to move to the value field on the right side of the display (Fig. 2.15).

Figure 2.15
Changing Element Values



Use the  or  keys to change the Value reading.

Changing Value Base

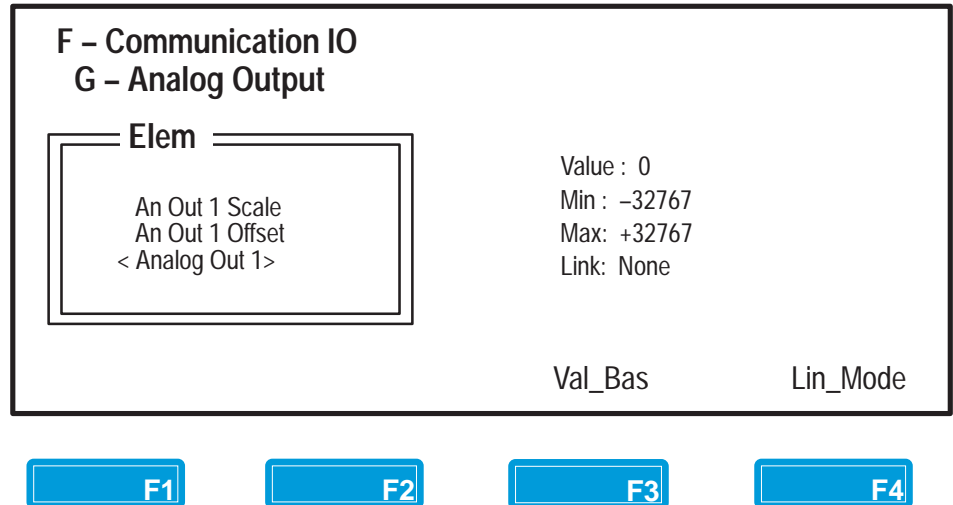

If you wish to work in a different Value Base, press the  soft designator key. The options shown in Figure 2.16 can be used.

Figure 2.16
Base Value Selections

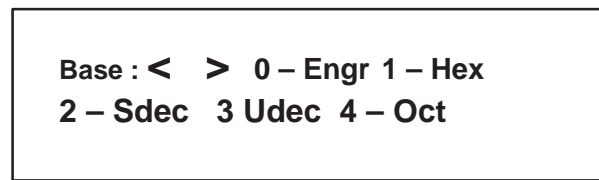

Enter the number for the base value you wish to use and press .

The screen will alter to show all element values in the selected base value. An indicator will appear to the right of the value to indicate the base selection (Fig. 2.17).

Figure 2.17
Base Value Selection

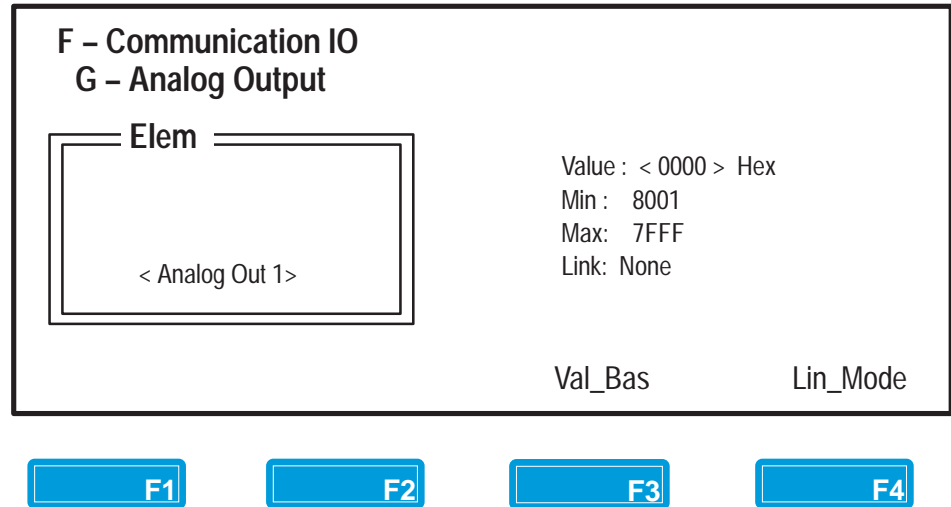

Exiting the FGE Mode



If you wish to exit the FGE mode and save any value changes, press the  key twice. The verification screen in Figure 2.18 will appear.

Figure 2.18
Base Value Selections

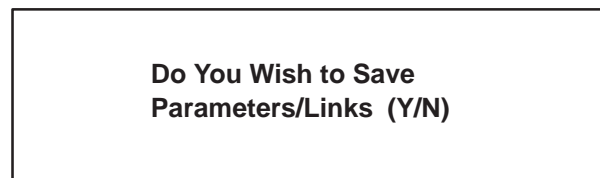

To save value changes, press  . To exit without saving values, press  .

Returning to the Linear Mode

If you wish to exit the FGE Mode and view parameters in the Linear Mode, press the  soft designator key while in an FGE Element or Group screen. The GPT will return to the Linear Mode and display the parameter that was last accessed before the FGE Mode was selected.

Fault & Warning Queues

Introduction

The Fault Queue and Warning Queue screens provide access to Fault and Warning Information stored in the drive.

When you activate either the Fault Queue Entry Screen or the Warning Queue Entry Screen, the four (4) most recent faults or warnings will be displayed on the left hand side of the screen. In the case of faults, if the fault caused the drive to trip, a TP designator will precede the fault text string.

The information box on the right hand side of the screen will provide the fault or warning code and the time stamp of the event.

Additional information to resolve faults can be accessed by pressing the RESOLVE key (F4 soft key) as shown in Figure 3.2.

Accessing the Fault Queue



From the Main Menu, use the  or  key to place the cursor on Option 3, Fault Queue (Figure 3.1).

Figure 3.1
Main Menu Options



Press the  key to access the Fault Entry Queue (Figure 3.2).

Figure 3.2
Fault Queue

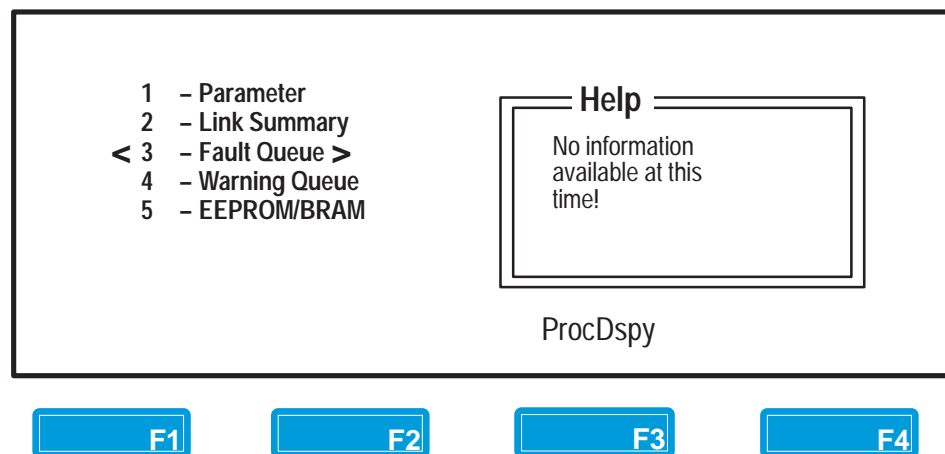

The latest four (4) fault entries will be displayed. If one of the four entries caused the drive to trip, a TP designator will precede the fault text string.

Clearing Faults

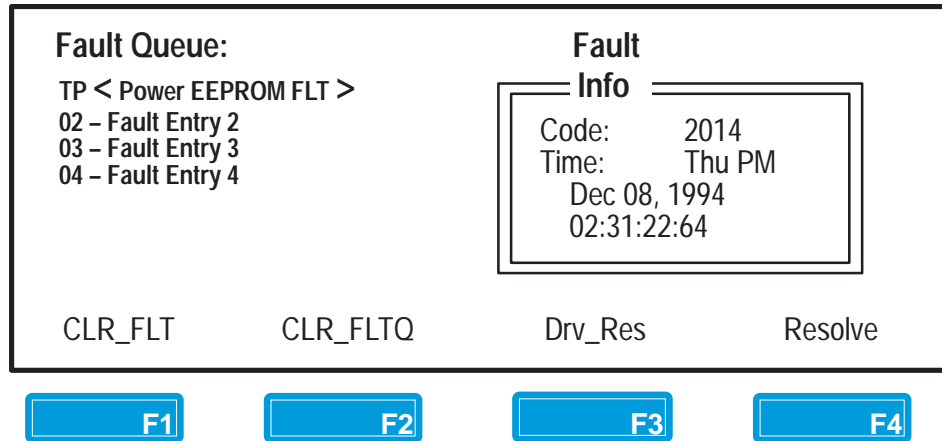

To clear all faults while leaving a visual record of the faults on the display press the  soft designator. A verification request will appear (Figure 3.3).

Figure 3.3
Clear Fault Verification Message



Press  soft designator for YES and  soft designator for NO. Upon successful completion of the clear, the #1 entry in the Queue will display CLEAR FAULTS to indicate Faults have been cleared.

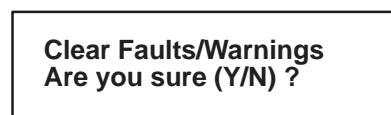

To clear the Fault & Warning QUEUE without leaving a visual record, press the  soft designator. A verification request will appear (Figure 3.4).

Figure 3.4
Clear Fault Queue Verification Message



Press  soft designator for YES and  soft designator for NO. Upon successful completion of the clear, the #1 entry in the Queue will display CLEAR FAULTS to indicate the Queue has been cleared.

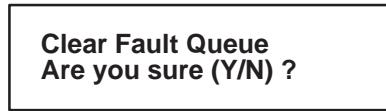

To reset the drive while in the Fault Queue, press the  soft designator. A verification message will appear as shown in Figure 3.5.

Figure 3.5
Reset Drive Verification Message

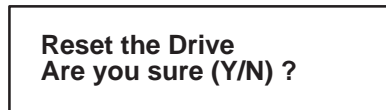

To return to the Main Menu, press the  key.

Accessing the Warning Queue



From the Main Menu, use the  or  key to place the cursor on Option 4, Warning Queue (Figure 3.6).

Figure 3.6
Main Menu Options



Press the  key to access the Warning Queue (Figure 3.7). The four (4) most recent entries will be displayed.

Figure 3.7
Warning Queue

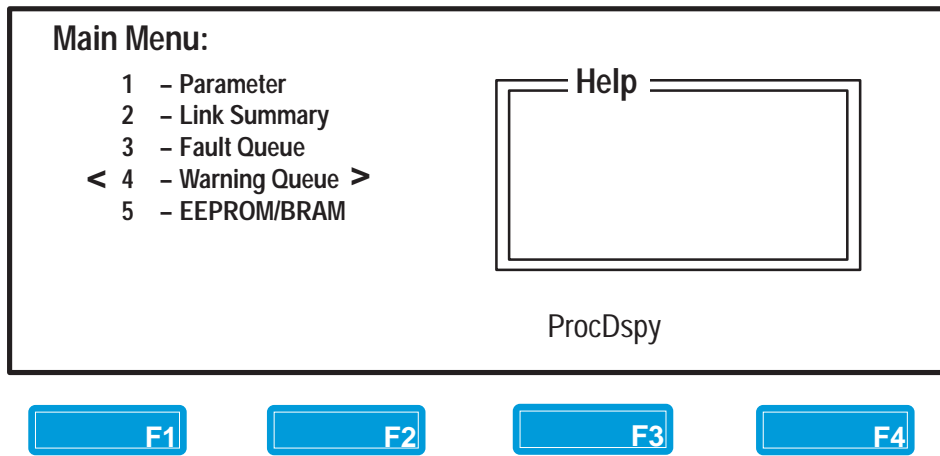

Clearing Warnings

To clear the Warning Queue while still leaving a visual record of the warnings on the display, press the  soft designator. A verification request will appear (Figure 3.8).

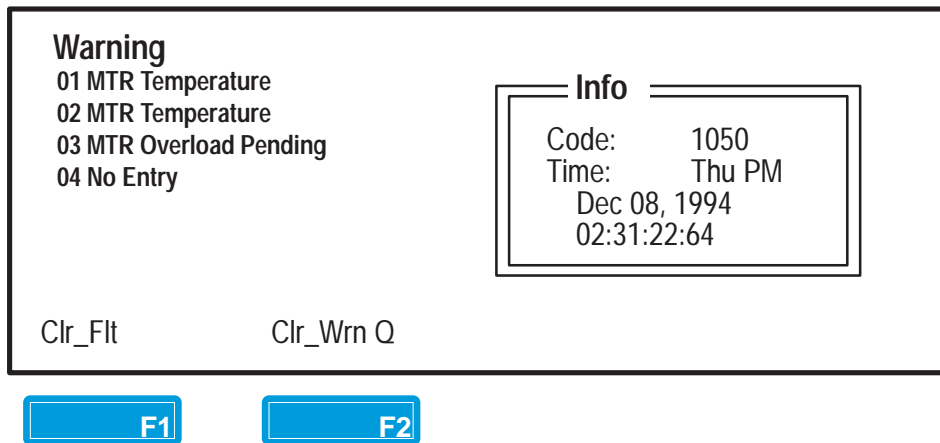
Figure 3.8
Clear Warning Verification Message



Press  soft designator for YES and  soft designator for NO.

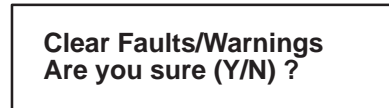

To clear the complete Warning Queue without leaving a visual record, press the  soft key. A verification request will appear (Figure 3.9).

Figure 3.9
Clear Warning Queue Verification Message

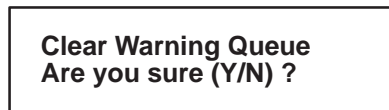

Press the  soft designator for YES and  soft designator for NO.

Press the  key to return to the Main Menu.

This Page Intentionally Blank

EE/BRAM Functions

General

The EE/BRAM Menu allows you to perform all non-volatile parameter storage functions. You can save parameter changes to the Battery RAM on the Adapter Board, save any process display changes you have made, or reset the parameter table to initial values using this menu.

A help text box will appear with each menu option describing the selected options.



Accessing the EE/BRAM Function From the Main Menu, use the  or  key to place the cursor on Option 5, EEPROM/BRAM (Figure 4.1).

Figure 4.1
Main Menu



Press the  key to access the EE/BRAM menu (Figure 4.2).

Figure 4.2
EE/BRAM Menu

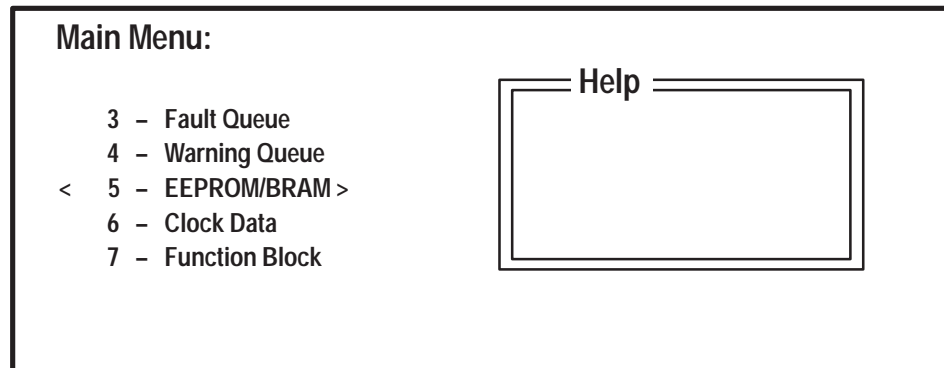

Saving Parameters to EE



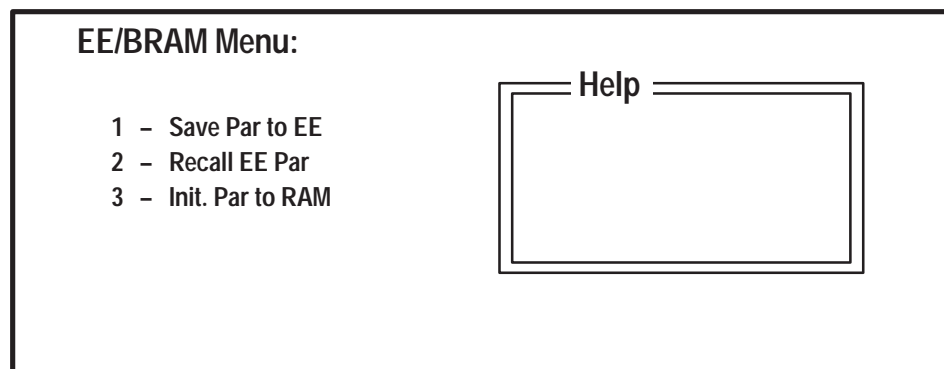

Select option two (2) in the EE/BRAM menu with  or  key. Press the  key to select the storage function. The display will respond with the question in Figure 4.3.

Figure 4.3
EE Parameter Save Verification

**Store Data Parameters
Are you sure (Y/N) ?**

To store all parameters to the non-volatile electronically erasable storage press the  soft designator (YES). To escape this function and return to the EE/BRAM menu, press the  soft designator (NO).

Recalling EE Parameters







Select option three (3) in the EE/BRAM menu with  or  key to recall the parameter table. Press the  key to select this option. The screen will respond with the question in Figure 4.4.

Figure 4.4
EE Parameter Recall Verification

**Recall Data Parameters
Are you sure (Y/N) ?**

Press the  soft designator for Yes or press the  soft designator (NO) to Escape this function and return to the EE/BRAM menu.

Saving Factory Defaults to RAM

To reset the parameter values to initial factory default values, choose option four (4) in the EE/BRAM menu with the  or  key.



Press the  key to select this option. The display will respond with the question in Figure 4.5.

Figure 4.5
Initial Parameters to RAM Verification

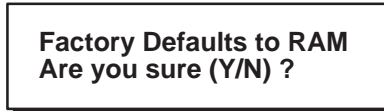

Press the  soft designator for Yes or press the  soft designator (NO) to escape this function and return to the EE/BRAM menu. If you choose Escape, another verification screen will prompt you on saving parameters.

This Page Intentionally Blank

Link Summary

General

This Main Menu option allows you to evaluate and change links in the system. The Sink parameter will always be displayed on the left side of the display and the Source parameter on the right. Each parameter will also display a File, Group and Element text string.

There are four types of link options that you may use for inter-linking within a system. These include:

1. Parameter to Parameter links
2. Parameter to Function Block Node links
3. Function Block Node to Parameter links
4. Function Block Node to Function Block Node links

To access Function Block links, you must use the Sel_Type option

( soft designator).

IMPORTANT: Only the first option (Parameter to Parameter) is currently accessible with this release of the GPT. The SEL_TYPE option is non functional at this time.

Accessing the Link Summary



From the Main Menu, use the  or  key to place the cursor on Option 2, Link Summary (Figure 5.1).

Figure 5.1
Main Menu



Press the  key to access the links currently in the system. The display will now show the first parameter in the system (Figure 5.2).

Figure 5.2
Initial Link Screen

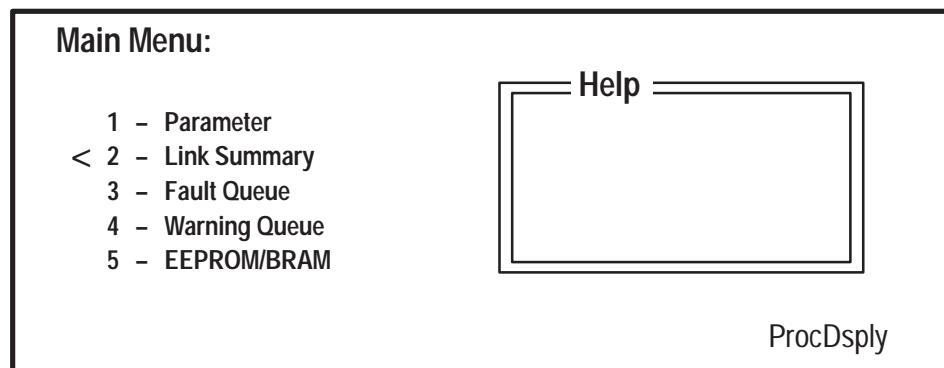

In this case, parameter 20 (Drive Link Transmit Data 1) is not currently linked to another parameter.

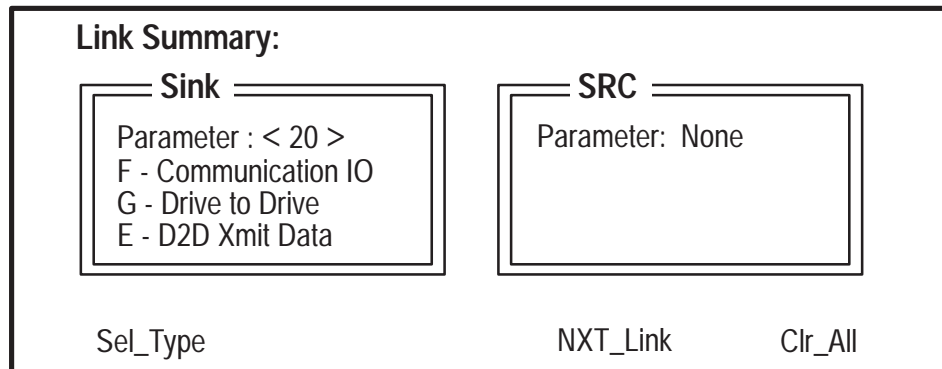

Searching for Linked Parameters

If you wish to check the link on a specific parameter, you may enter the parameter number directly in the Sink Parameter display using the numeric keys.

If you wish to scroll to the next linked parameter, press the  key or use the F3 soft designator key.

The text "Searching" will appear on the display as the GPT scrolls through the parameter table searching for links. If no link is found, the display stops at the point where the search began.

Changing or Adding Parameter Links

Scroll to the Sink parameter you wish to link to another parameter by using the  or  key or the search function () key.



Press the  key to move the cursor to the source field (SRC Figure 5.3).

Figure 5.3
Changing Links

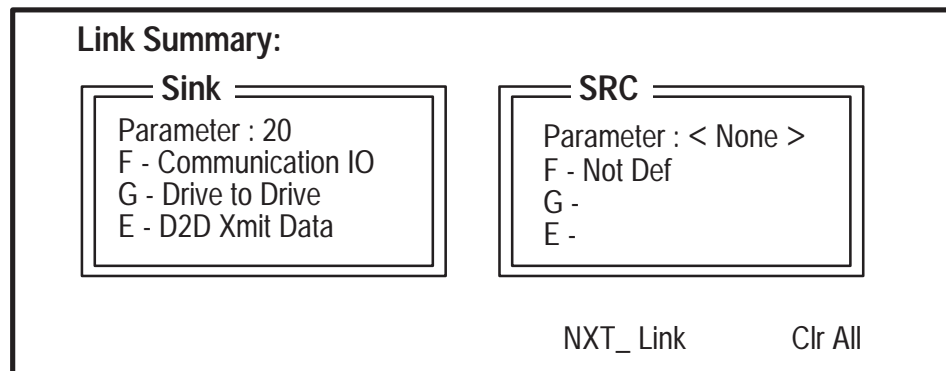

To change the parameter number in the Source field use the  or  key, or enter the number directly with the numeric keys.

To clear an entered number from the Source field use the  key to remove the digits.

Saving Parameter Links

Once you have entered all changes to Sink and Source links, press the





key to save these links.

The verification message in Figure 5.4 will appear.

Figure 5.4
Save Link Verification Message



To save all links, press the  soft designator (YES)). To escape the Link Verification and return to the Main Menu without saving your changes press the  soft designator (NO).

Clearing All Links in the System:

To clear all current links in the system, access a Link Summary Screen (Figure 5.5).

Figure 5.5
Clearing Links

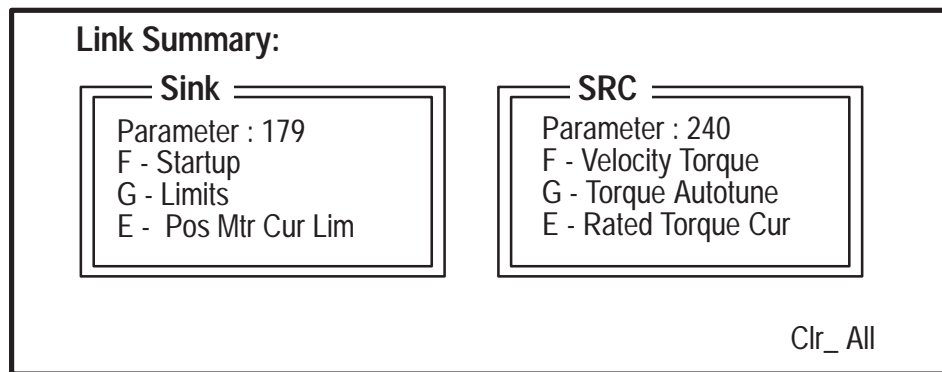

The Clr_All function is located in the bottom right corner of the display and is linked to the F4 soft designator key. Press the  soft designator and the verification message in Figure 5.6 will appear.

Figure 5.6
Clear Link Verification Message



To clear all links, press the **F1** soft designator. To leave all the links intact and return to the Previous Screen, press the **F4** soft designator.

Changing or Adding Function Block Links

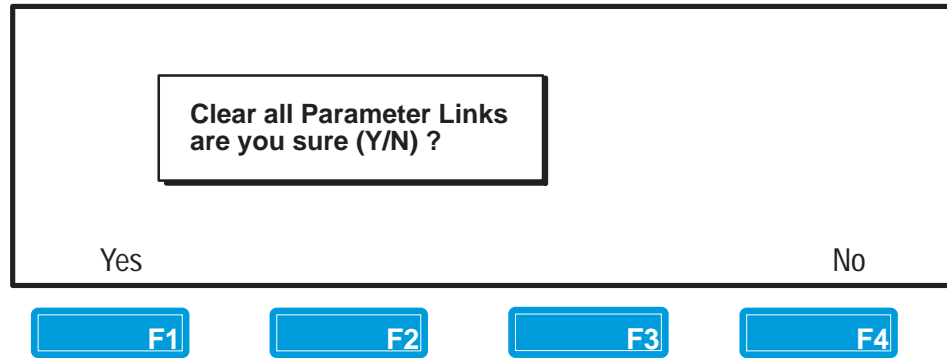
From the Link Summary Screen, press the  soft key and the display shown in Figure 5.7 will appear.

Figure 5.7
Link Type Selection



Choose the Function Block Option by pressing  and then

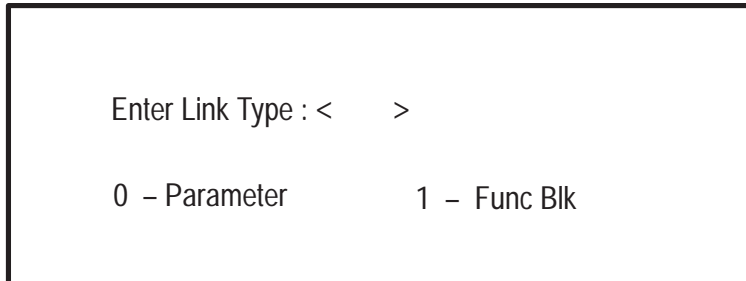

. The Display shown in Figure 5.8 will now appear.

Figure 5.8
Node to Parameter Display

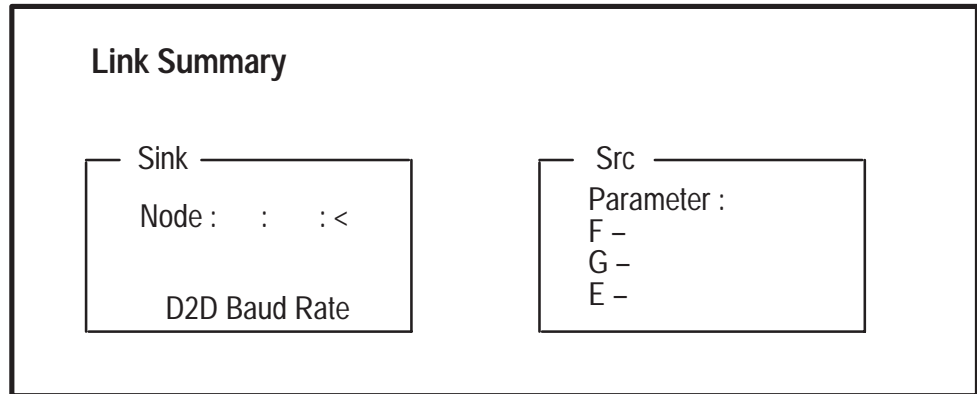

IMPORTANT: The screen shown in Figure 5.8 allows you to enter the information needed to Link a Node to a Parameter for Function Block linking.

The Node to Parameter;
Parameter to Node;
and Node to Node;
options are currently non-functional. Only Option 0, Parameter to
Parameter linking should be attempted at this time.

For additional information on Function Block linking, refer to the Advanced
Programming Manual 1336–5.9.

Clock Data

General

This Main Menu option allows you to program clock and time functions within the Drive.

The software function keys are programmed to allow you to set the clock (Set_Clk), set the time reference (Set_Ref), zero the accumulator (Zero_Acc) or load the clock into reference (Load_Ref).

Accessing the Clock Data Function



From the Main Menu, use the  or  key to place the cursor on Option 6, Clock Data (Figure 6.1).

Figure 6.1
Main Menu



Press the  key to access the Clock Data Main Display (Figure 6.2).

Figure 6.2
Clock Data Main Display

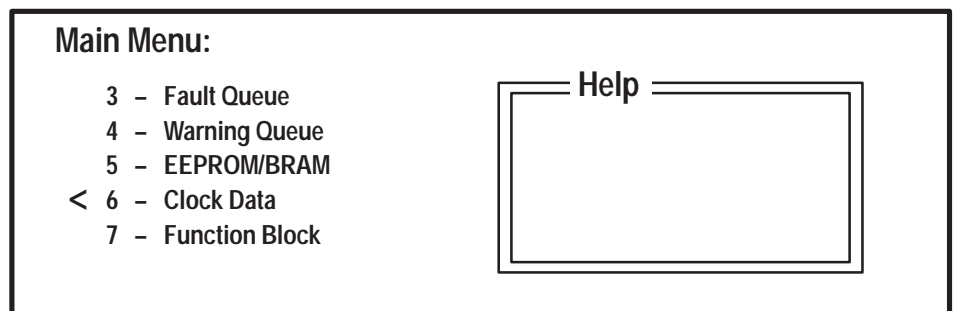

Setting the Clock



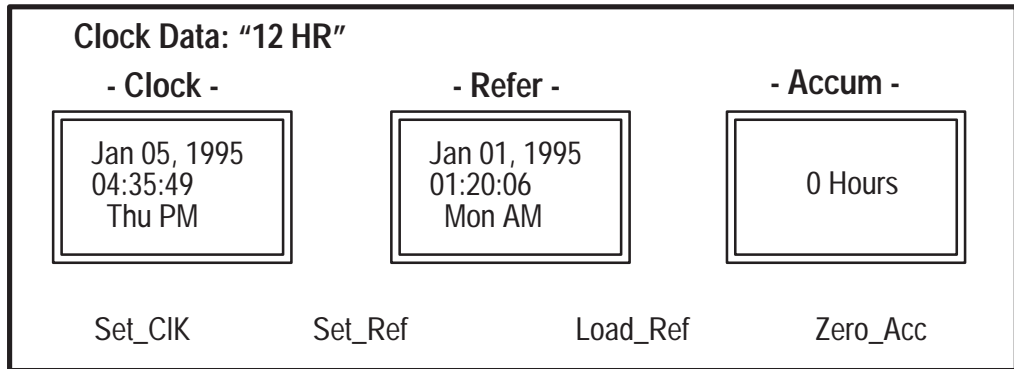



From the Clock Data Main display, press the  soft designator to access the Set Clock display (Figure 6.3).

Figure 6.3
Set Clock Display

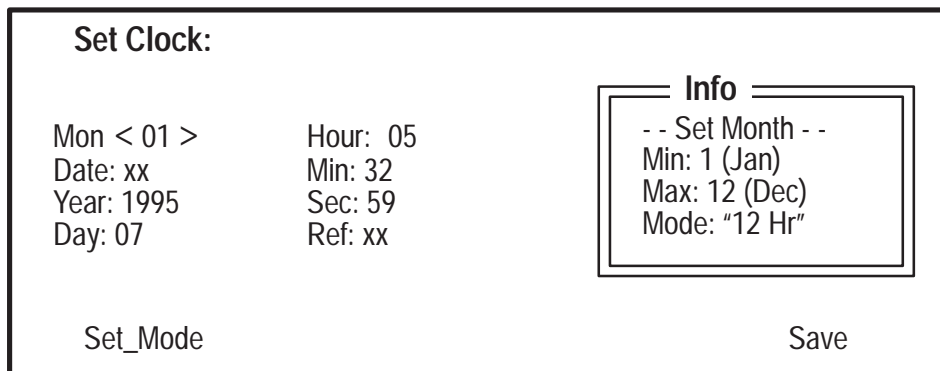

Use the  or  key to scroll to the data item you wish to change (Month, Day, Sec. etc.). Use the  or  key to change the data. When changes are complete, press the  soft designator to save the changes and return to the Clock Data Main Display.

Setting the Reference

This option allows you to set the reference manually to a specific date & time for record keeping purposes.







From the Clock Data Main Display press the  soft designator key to access the Set Reference Display (Figure 6.4).

Figure 6.4
Set Reference Display

Set Reference:

Mon < 12 >	Hour: 01	Info -- Set Month -- Min: 1 (Jan) Max: 12 (Dec) Mode: "12 Hr"
Date: xx	Min: 21	
Year: 1994	Sec:	
Day: 05	Ref: xx	
Set_Mode		Save

Use the  or  key to scroll to the data item you wish to change (Day, Hour, Min etc.). Use the  or  key to change the data. When changes are complete, press the  soft designator to save the changes and return to the Clock Data Main Display.

Loading the Reference

This option allows you to load the current Date and Time into the reference for record keeping purposes.



From the Clock Data Main Display, press the  soft designator key to load the clock into reference. The verification screen shown in Figure 6.5 will appear.

Figure 6.5
Load Reference Verification Display

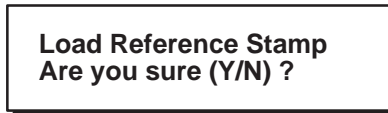

To load the current clock reference press the  soft designator (YES). To return to the Set Clock Main Display without loading the reference, press  (NO).

Zeroing the RT Accumulator



From the Set Clock Main Display press the  soft designator. The verification screen in Figure 6.6 will appear.

Figure 6.6
Zero RT Accumulator Verification Display

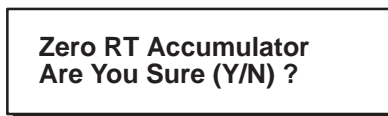

To zero the RT Accumulator press the  soft designator (YES). To return to the Set Clock Main Display without zeroing the accumulator, press  soft designator (NO).

Process Display

General

The Process Display option can supply you with information on up to six (6) programmed process variables. The process variables will allow you to monitor the programmed parameter, scale it with the scale factor and add a customized text string. You also have the option of displaying different types of information on the right hand side of the display in the mode window.

The Mode options that are available include:

1. An AB Logo Graphic
2. A Drive Status Report
3. A metering bar graph display

The configurable items that are available to you in the Process Display include:

1. Programming Parameter Data Source
2. Programming Scaling Factor
3. Programming Text String
4. Recalling Process Display Data
5. Initializing all Process Display Data
6. A Blank Text String
7. An Enable/Disable Display Variable

Accessing the Process Display

If it has not been deactivated, the Process Display Screen can be accessed from the Main Menu display. With the Main Menu called up, press the



soft designator key to access the Process Display

(Figure 7.1).

Figure 7.1
Process Display Screen

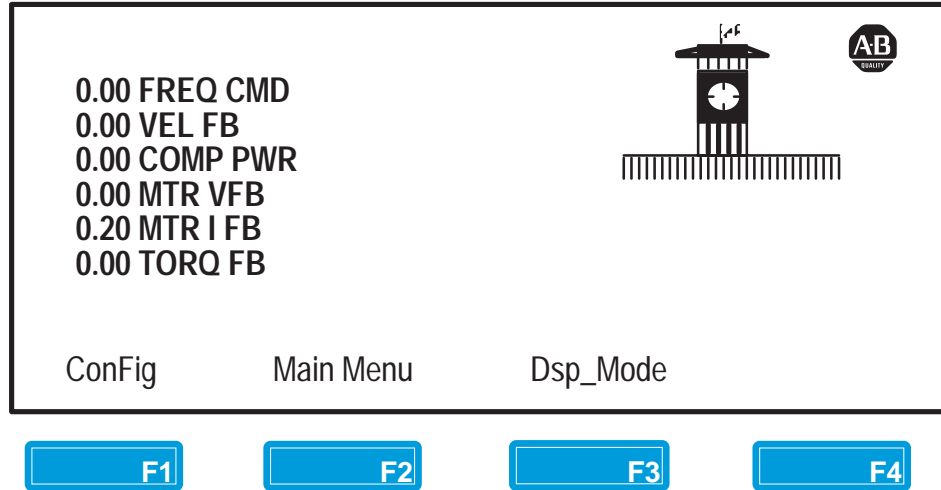

In this case the Process display came up in the AB-Logo mode.

Accessing the Drive Status Mode

To access the Drive Status Mode from the initial Process Display, press the



soft designator key.

The Mode entry window in Figure 7.2 will appear.

Figure 7.2
Mode Selection Window

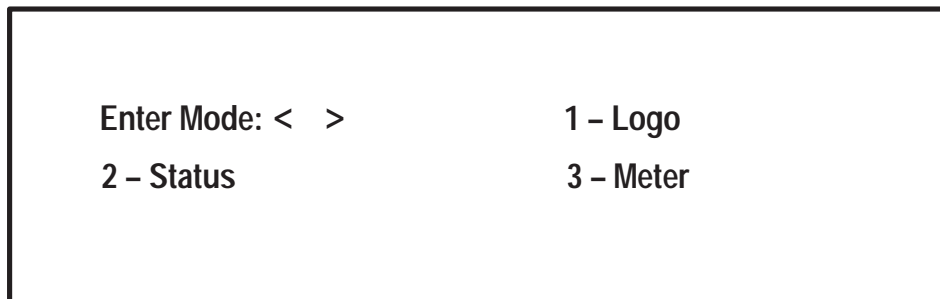



Press the  key to enter the number 2 and then press  to call up the Status Mode (Figure 7.3).

Figure 7.3
Status Mode (Option 2)



Accessing the Metering Mode

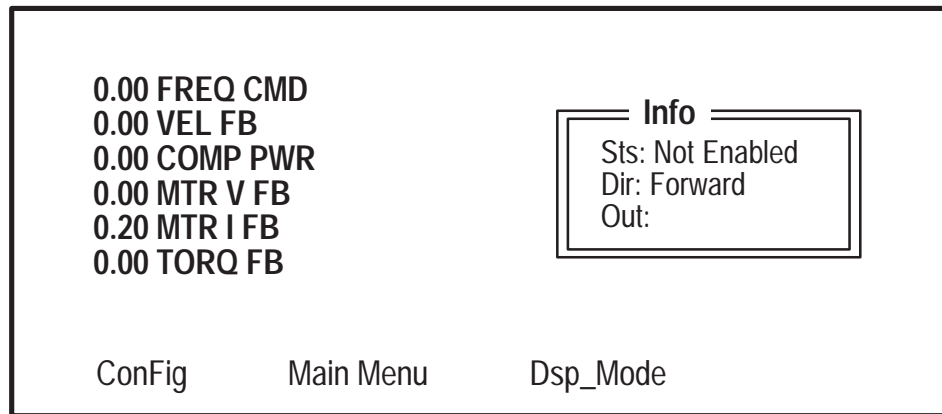

Press the  soft designator key to call up the Mode selection window (Figure 7.2). Press the  key to enter number 3 and then press  to call up the Metering Mode (Figure 7.4).

Figure 7.4
Metering Mode (Option 3)



Accessing the Configuration Mode From any Process Display window press the  soft key to call up the Configuration display (Figure 7.5).

Figure 7.5
Configuration Display

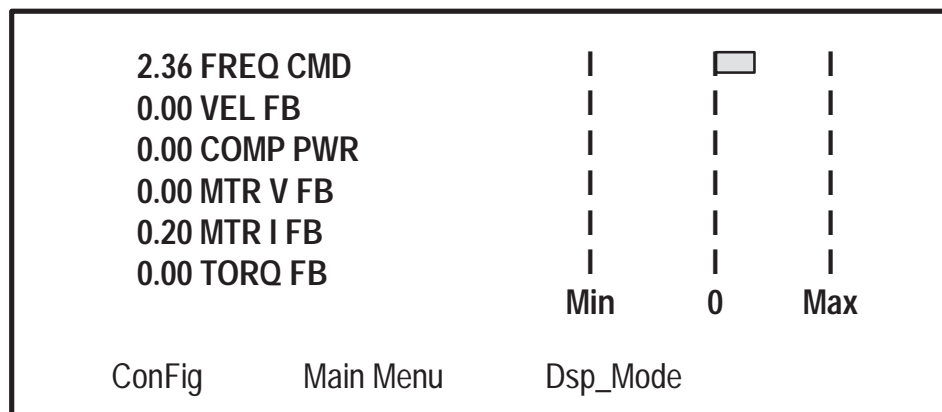

Disabling a Process Display Variable



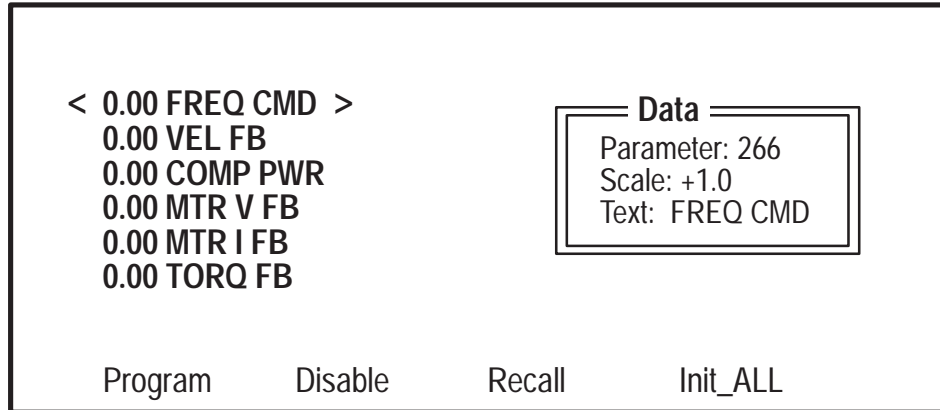



To disable a process display variable use the  or  key to place the cursors on the variable you wish to Disable. Press the  soft designator. The data display window will change to display “None” in the parameter line (Figure 7.6).

Figure 7.6
Disable Parameter Configuration Display

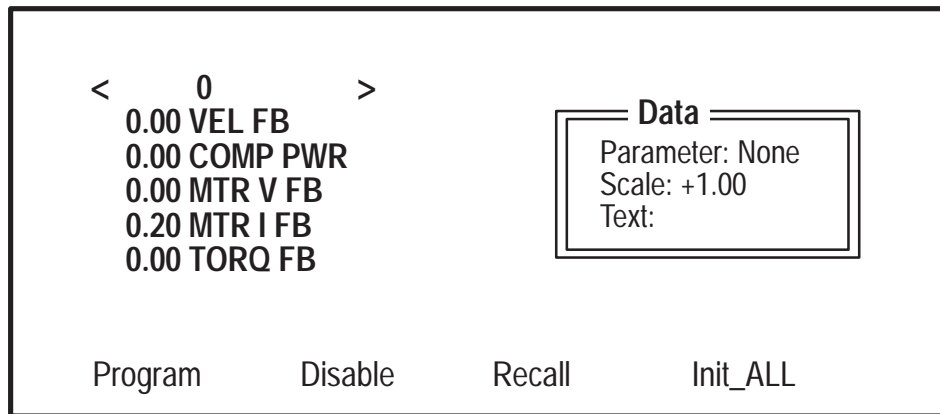

If you wish to re-enable the parameter that was just removed press the  soft designator key again. The  soft designator has now changed to an Enable variable.

Recalling a Process Display Variable

If you have removed or disabled one Process Display variable and wish to recall it from the drive, place the cursors on the selected Process Display location with the  or  key. Press the



soft designator and the parameter will be restored to the Process Variable list.

Programming a Configurable Variable

With the Process Configuration Display called up, select the variable you wish to change by placing the cursors on the variable with the  or



key. Press the  soft key to call up the

Configuration Programming Screen (Figure 7.7).

Figure 7.7
Configuration Program Display

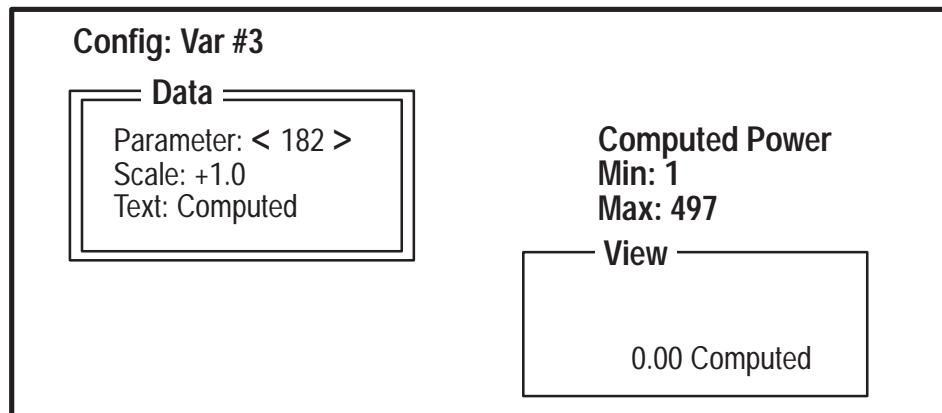

Changing Parameter Numbers: If you wish to change the parameter number, place the cursors on the Data Parameter option using the



key. Use the  and  keys

to change Variable #3 to the desired Parameter Number. Or you can directly enter a parameter number using the numeric keys.

Changing the Scaling Factor: Use the  or  key to

place the cursors on the Data Scale option. Use the  or



keys to change the Scaling Factor (Figure 7.8) or enter the desired scaling factor directly with the numeric keys.

Figure 7.8
Configuration Scaling Display

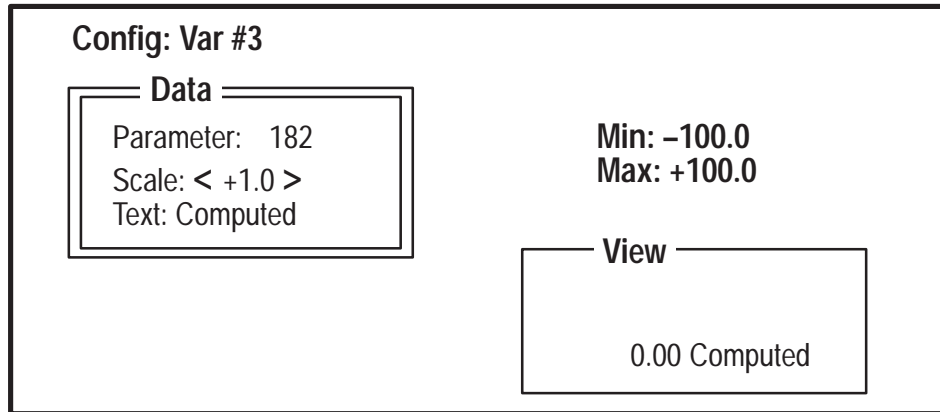

When the new scaling value is entered correctly, press the  key to save the value and return to the Main Configuration window.

Changing the Configuration Text:









Place the cursors (< >) on the Text variable using the  or  key. Continue to use the  or  keys to place the character selection cursor (\$ sign) under the character you wish to change (Figure 7.9).

Figure 7.9
Text Configuration Display

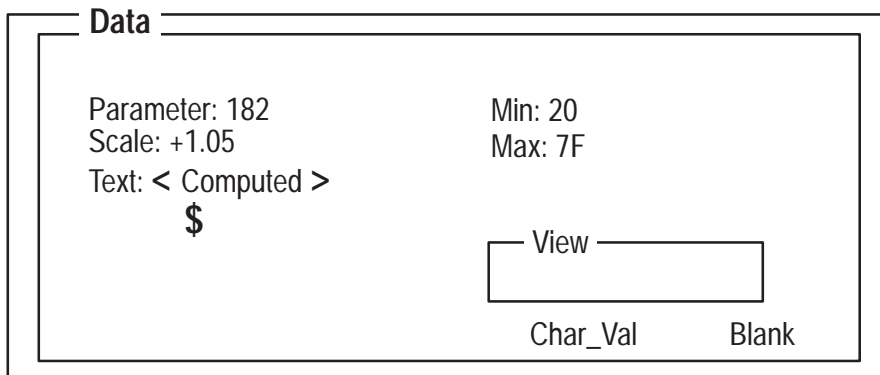

Use the  or  key to scroll through the alphabet and replace the selected letter with new text. All Upper and Lower case letters and some additional keyboard symbols are available. Once you have reached

the new letter or character you wish to enter, press the  to save this new character.

If you wish to delete the complete word and enter a new word, press the  soft key to blank out the complete text line.



It is also possible to enter the text in hex. Press the  soft key to activate the Char_Val option. The display will respond with the window shown in Figure 7.10.

Figure 7.10
ASCII Entry Dialog Box

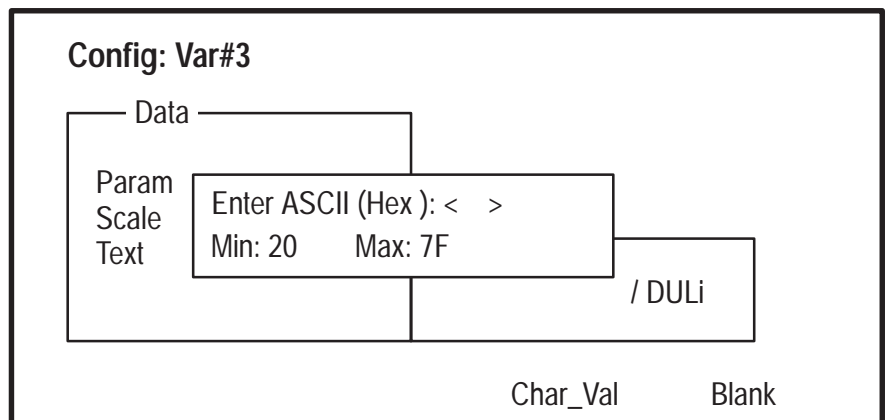

Enter your desired ASCII text within the cursors and press the  key to save the new characters.

This Page Intentionally Blank

Special Menu

General

The Special function is a dynamic list of options that varies with the Drive State and the Drive Product being used.

Options that may be available under the Special Menu include Autotuning, Trending, Diagnostics, Password, Drive Identity and Version information.

Each option has a Help box that describes the function of this option.

Accessing the Special Menu Function



From the Main Menu, use the  or  key to place the cursor on option eight (8) Special (Figure 8.1).

Figure 8.1
Main Menu



Press the  key to access the Special Menu (Figure 8.2).

Figure 8.2
Special Menu

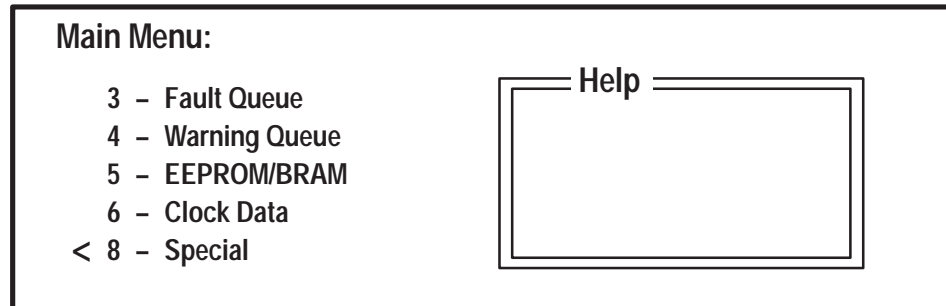

Changing & Entering a Password



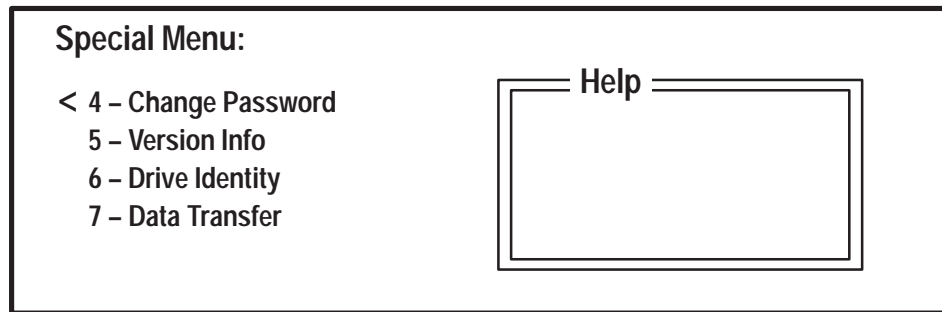

From the Special Menu use the  or  key to place the cursor on option four (4) Change Password. Press the  key to access the Change Password display (Figure 8.3).

Figure 8.3
Change Password Display



Enter the current password within the cursors using the numeric keys. If there is currently no password assigned, press the  key and then the

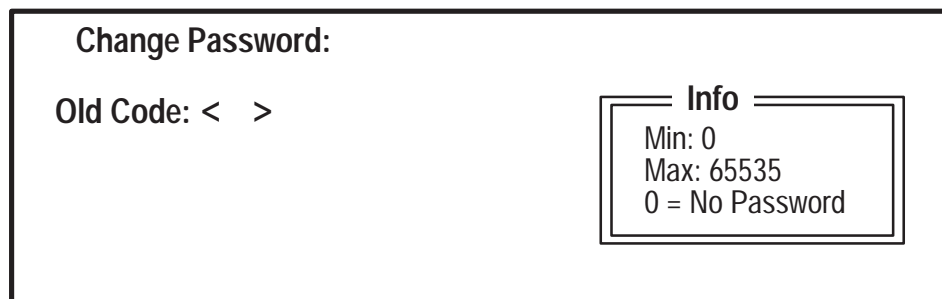

key. The New Code request will appear as shown in Figure 8.4.

Figure 8.4
New Code Request

Old Code: ?
New Code:< >



Enter your new code with the numeric keys and then press the  key. The GPT will respond with the message in Figure 8.5.

Figure 8.5
Password Change Verification

Old Code: ?
New Code: ?
Verify: < >

Re-enter your new password with the numeric keys and press .

The GPT will return to the Special Menu when the new password is accepted.

IMPORTANT: If you enter zero (0) as the New Code, the old code line will remain. Numeric choices from 1 to 65535 should be used if you do not wish to return to the old password.

Inspecting Version Information



From the Special Menu, use the  or  key to select option five (5) Version Info. Press the  key and the display will show the current version of the GPT, and all processors in the drive (Figure 8.6).

Figure 8.6
Version Information Display

Version: B 1336T Vector		
GPT	SW = V 0.04	LM = V 0.04
VP	SW = V 1.02	LM = V 1.02
CP	SW = V 1.02	LM = V 1.02
AP	SW = V 1.02	LM = V 1.02
DP	SW = V 1.01	LM = V 1.01

This is a read only Display, NO user changes can be made to this display using the GPT.

To return to the Special Menu press



Changing Drive Identity



From the Special Menu use the  or  key to select option six (6) Drive Identity. Press the  key and the Drive Identity display in Figure 8.7 will appear.

Figure 8.7
Drive Identity Display

Drive Identity	
Data	
Name:	
\$	
--(Char#)--	
Char_#	Char_Val

!"#\$%&()*+,-./
0123456789:;<=>?
@ABCDEFGHIJKLMNO
PQRSTUVWXYZ[\]^_
`abcdefghijklmnopqrstuvwxyz(!)~



To enter a name of up to sixteen characters activate the character # selection by pressing the  soft designator key. The dialog box shown in Figure 8.8 will appear.

Figure 8.8
Character Entry Box

Enter Character #: < >
Min: 1 Max: 16

To enter the first character press the  key and then the



The \$ sign will now appear at position 1 indicating the first character can be entered or changed at this point (Fig. 8.9).

Figure 8.9
Character Entry Indicator

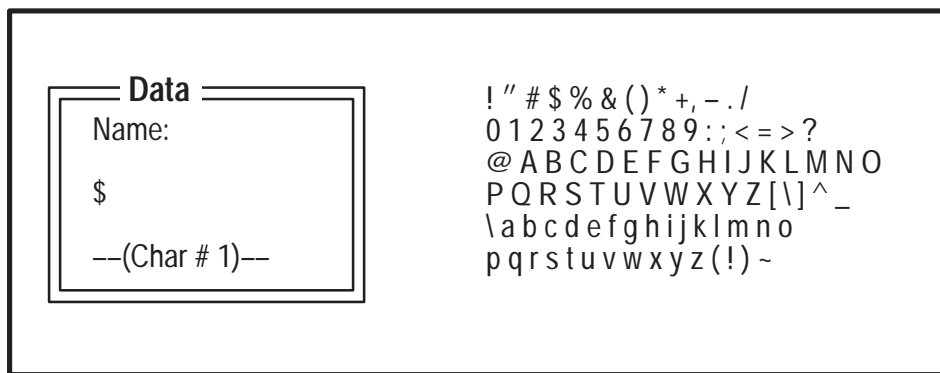

Use the  or  key to scroll through the character

selection chart on the right side of this display. In this case place the # cursor on the capital B and the letter B will appear in the first position under the name entry (Figure 8.10).

Figure 8.10
Character Entry

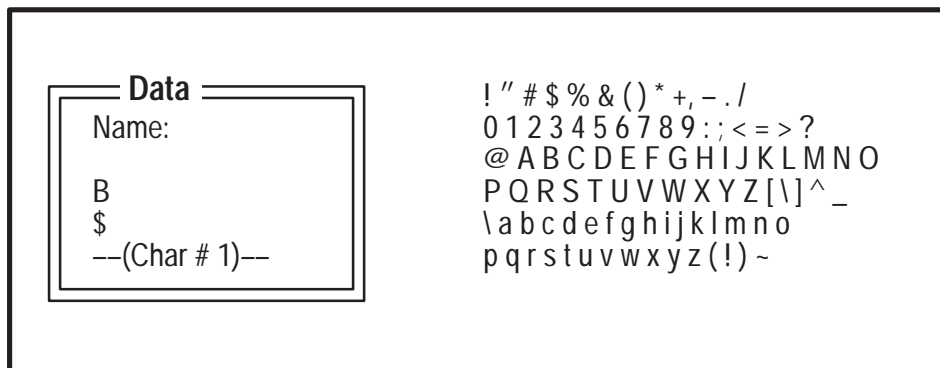

Continue the entry process by pressing the  soft

designator and then entering number 2 in the character entry box. Enter your desired character for position #2. Continue this sequence until you have entered as many name characters as you wish, up to a maximum of sixteen. When you have entered all Drive Identity name characters as you wish them to appear, press the  key. The new name will be saved and the display will return to the Special Menu.

Changing Drive Identity in Hex

The Drive Identity name can also be changed by using the Char_Val option to enter hex values for the characters in the character selection chart.

With the drive identity display selected, press the Char_Val soft designator



. The dialog box shown in Figure 8.11 will appear.

Figure 8.11
ASCII (Hex) Dialog Box

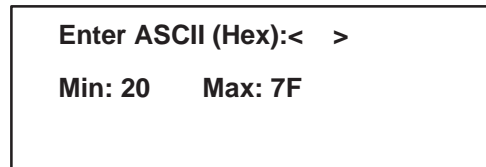

Enter ASCII (Hex):< >
Min: 20 Max: 7F

Enter the value 4F with the keyboard. The ASCII equivalent of 4F which is a capital O will appear at position one (1) of the name (Figure 8.12).

Figure 8.12
ASCII Name Entry

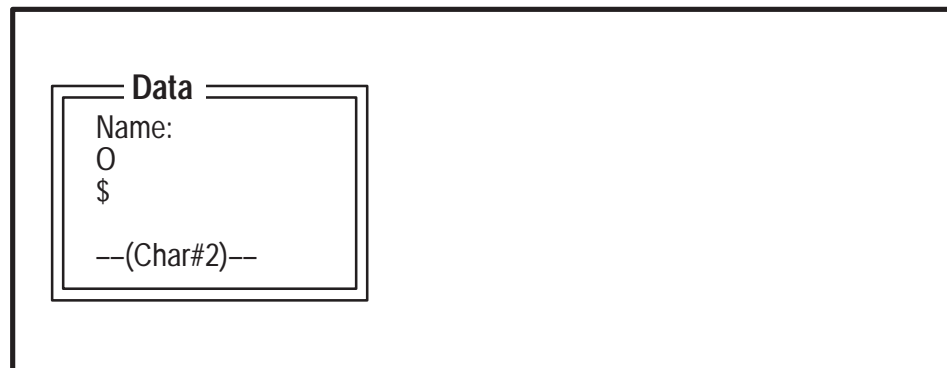

Data

Name: O \$ --(Char#2)--

When you have entered all of the hex values you wish for the Drive Identity, press the  key. The ASCII name will be saved and the GPT will return to the Special Menu display.

Accessing the Data Transfer Function



From the Special Menu use the  or  key to select Option 7; Data Transfer. Press the  key and the Data Transfer display will appear as shown in Figure 8.13.

Figure 8.13
Data Transfer Display



Uploading

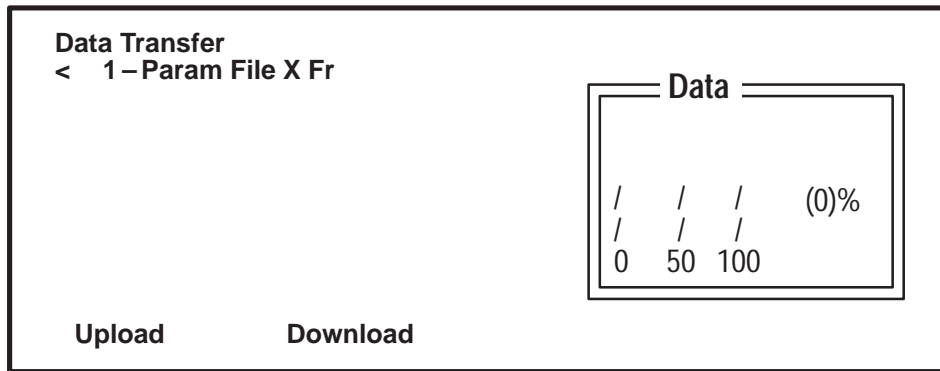

To Upload the Param File, press the  soft designator key. The verification message shown in Figure 8.14 will appear.

Figure 8.14
Parameter File Upload Verification

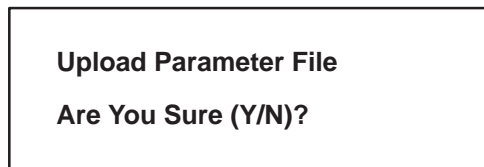

Press the  designator to initiate the upload (YES), and the  key to return to the Data Transfer Display (NO).

When you press the  designator the loading will occur as shown in Fig. 8.15. A bar chart will scroll across the bottom of the Data Screen to indicate the percentage of the parameter table that is uploaded.

Figure 8.15
Parameter File Upload



To cancel an Upload press the **F4** soft designator key.

Downloading

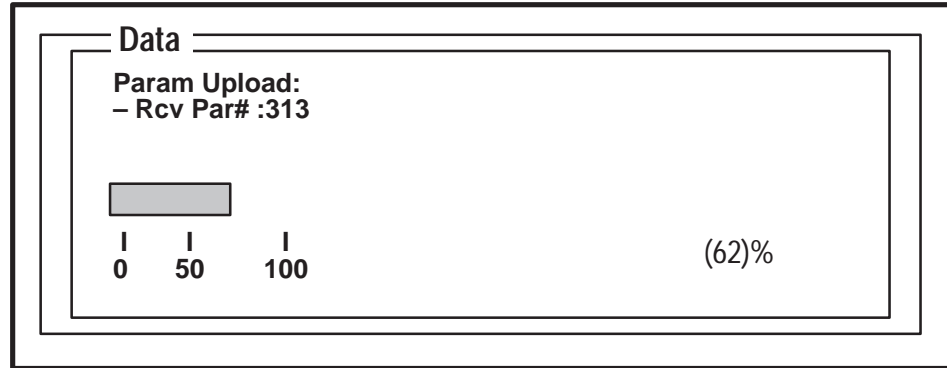
To Download the Parameter File press the **F2** soft

designator while in the Data Transfer Display. A verification message will appear as shown in Figure 8.16.

Figure 8.16
Data Download Verification

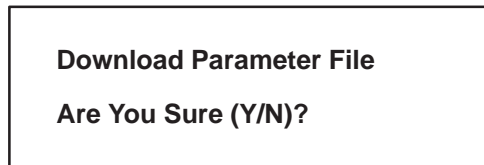

Press the **F1** soft key to download (YES) or the

F4 soft key to return (NO) to the Data Transfer Display.

When you press the **F1** soft designator key the Download display shown in Figure 8.17 will appear.

Figure 8.17
Parameter File Download

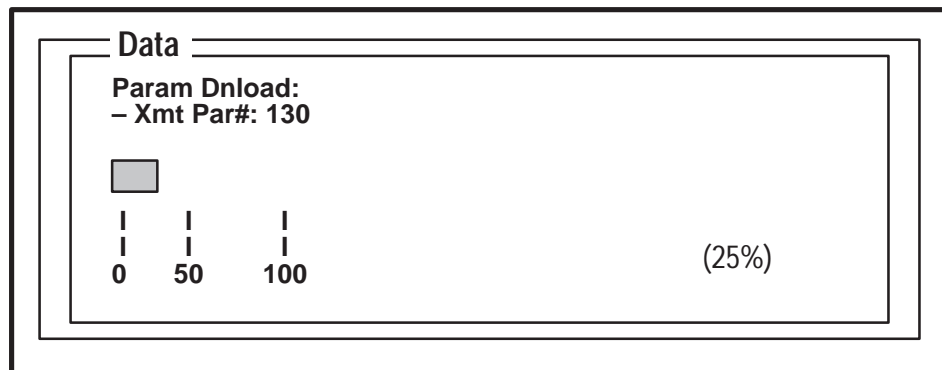

A bar chart will scroll across the bottom of the Data Display to indicate the percentage of the parameter table that is downloaded.

To cancel a download press the **F4** soft designator.



Allen-Bradley, a Rockwell Automation Business, has been helping its customers improve productivity and quality for more than 90 years. We design, manufacture and support a broad range of automation products worldwide. They include logic processors, power and motion control devices, operator interfaces, sensors and a variety of software. Rockwell is one of the world's leading technology companies.

Worldwide representation.



Argentina • Australia • Austria • Bahrain • Belgium • Brazil • Bulgaria • Canada • Chile • China, PRC • Colombia • Costa Rica • Croatia • Cyprus • Czech Republic • Denmark • Ecuador • Egypt • El Salvador • Finland • France • Germany • Greece • Guatemala • Honduras • Hong Kong • Hungary • Iceland • India • Indonesia • Ireland • Israel • Italy • Jamaica • Japan • Jordan • Korea • Kuwait • Lebanon • Malaysia • Mexico • Netherlands • New Zealand • Norway • Pakistan • Peru • Philippines • Poland • Portugal • Puerto Rico • Qatar • Romania • Russia-CIS • Saudi Arabia • Singapore • Slovakia • Slovenia • South Africa, Republic • Spain • Sweden • Switzerland • Taiwan • Thailand • Turkey • United Arab Emirates • United Kingdom • United States • Uruguay • Venezuela • Yugoslavia

Allen-Bradley Headquarters, 1201 South Second Street, Milwaukee, WI 53204 USA, Tel: (1) 414 382-2000 Fax: (1) 414 382-4444