

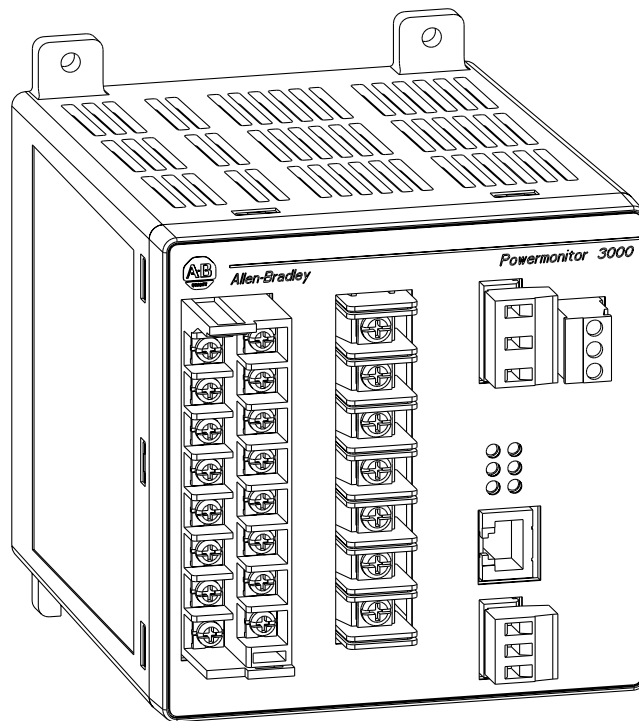

Bulletin 1404 Remote I/O Communication Port

(Catalog Number 1404-Mxxx-RIO)



1404-Mxxx-RIO

Important User Information

Because of the variety of uses for the products described in this publication, those responsible for the application and use of this control equipment must satisfy themselves that all necessary steps have been taken to assure that each application and use meets all performance and safety requirements, including any applicable laws, regulations, codes and standards.

The illustrations, charts, sample programs and layout examples shown in this guide are intended solely for purposes of example. Since there are many variables and requirements associated with any particular installation, Allen-Bradley does not assume responsibility or liability (to include intellectual property liability) for actual use based upon the examples shown in this publication.

Allen-Bradley publication SGI-1.1, *Safety Guidelines for the Application, Installation and Maintenance of Solid-State Control* (available from your local Allen-Bradley office), describes some important differences between solid-state equipment and electromechanical devices that should be taken into consideration when applying products such as those described in this publication.

Reproduction of the contents of this copyrighted publication, in whole or part, without written permission of Rockwell Automation, is prohibited.

Throughout this manual we use notes to make you aware of safety considerations:

ATTENTION



Identifies information about practices or circumstances that can lead to personal injury or death, property damage or economic loss

Attention statements help you to:

- identify a hazard
- avoid a hazard
- recognize the consequences

IMPORTANT

Identifies information that is critical for successful application and understanding of the product.

PLC and PLC-5 are registered trademarks of Rockwell Automation.
Powermonitor 3000, RSView32, RSLinx, SLC 500, and ControlLogix are trademarks of Rockwell Automation.
Belden is a trademark of Belden, Inc.

European Communities (EC) Directive Compliance

If this product has the CE mark it is approved for installation within the European Union and EEA regions. It has been designed and tested to meet the following directives.

EMC Directive

This product is tested to meet the Council Directive 89/336/EC Electromagnetic Compatibility (EMC) by applying the following standards, in whole or in part, documented in a technical construction file:

- EN 50081-2 EMC — Generic Emission Standard, Part 2 — Industrial Environment
- EN 50082-2 EMC — Generic Immunity Standard, Part 2 — Industrial Environment

This product is intended for use in an industrial environment.

Low Voltage Directive

This product is tested to meet Council Directive 73/23/EEC Low Voltage, by applying the safety requirements of EN 61131-2 Programmable Controllers, Part 2 - Equipment Requirements and Tests. For specific information required by EN 61131-2, see the appropriate sections in this publication, as well as the Allen-Bradley publication Industrial Automation Wiring and Grounding Guidelines For Noise Immunity, publication 1770-4.1.

This equipment is classified as open equipment and must be mounted in an enclosure during operation to provide safety protection.

Product Description	Chapter Objectives	1
	Introduction	1
	Performance Features	1
	Prevent Electrostatic Discharge	2
	Wiring	3
	Remote I/O Capabilities Table	3
	Field Service Considerations	5
	General Operation	5
	Communication Port Set-Up	5
	Indicators	5
	Configuration Items	6
	Communication	6
	Remote I/O Communication Configuration Items	6

Catalog Number Explanation Appendix A

Data Tables Appendix B

Summary of Powermonitor 3000 Data Tables for RS-485 and Remote I/O Communication Protocols	B-1
Remote I/O Messaging Discrete Data Provided by Powermonitor 3000 (Master Input Data)	B-2
Remote I/O Messaging Discrete Data Accepted by Powermonitor 3000 (Master Output Data)	B-2
Discrete Data (BT# 10)	B-3
Basic Device Configuration (BT# 20)	B-3
Date and Time (BT# 12)	B-4
Advanced Device Configuration (BT# 26)	B-4
RS-485 Communication Configuration (BT# 11)	B-6
Remote I/O Communication Configuration (BT# 24)	B-7
Metering Voltage, Current and Frequency Results (BT# 38)	B-7
Metering Sequence Voltage and Current Results (BT# 27)	B-8
Metering Power Results (BT# 31)	B-9
Metering Demand Results (BT# 25)	B-10
Metering Power Factor Results (BT# 33)	B-10
Metering Real and Apparent Energy Results (BT# 29)	B-11
Metering Reactive Energy and Amp-Hour Results (BT# 30)	B-12
Selftest/Diagnostic Results (BT# 36)	B-12
Setpoint Setup/Readback Select and Status (BT# 22)	B-14
List of Setpoint Types	B-15
Setpoint Output Actions	B-16
Trend Log Configuration/Readback Record Select (BT# 34)	B-17
Trend Log Data (Large Read) (BT# 48)	B-18
Min/Max Log Configuration/Readback Element Select (BT# 13)	B-19
Min/Max Log Parameter List	B-19

Min/Max Log Results (BT# 28) B-20
Event Log Configuration/Readback Record Select (BT# 9) ... B-21
Event Log Results (BT# 21) B-21
List of Event Types B-22
User Configured Table Setup (BT# 35) B-23
User-Configured Table Results (BT# 6, 32, 62) B-24
Write Error Status (BT# 4) B-24
Harmonic Analysis Configuration/Readback
Data Select (BT# 14) B-25
Harmonic Results; THD, Crest Factor, and more (BT# 23) ... B-25
List of Parameters for Trend Log and Configurable Table B-26

**Remote I/O Communications
Ladder Diagrams**

Appendix C

Ladder Program Description C-1
 PLC-5 R I/O Operation C-1
 PLC-5 R I/O Data Files Used C-1
 File Data Values C-2
Sample Ladder Listing C-2

Index

Product Description

Chapter Objectives

After completing this chapter, you should be able to identify the product features and system applications.

Introduction

Catalog Number 1404-Mx05A-RIO is a Powermonitor 3000 with a microprocessor-controlled dual-port communications option for the Powermonitor 3000. The Remote I/O communication option provides the Powermonitor 3000 with two active communication ports. One port is dedicated to the Remote I/O network and the other port is dedicated to RS-485. The Master Module sets the required communications configuration parameters. For more information on the DF1 (RS-485) communication port, refer to the *Bulletin 1404 RS-485 and RS-232 Communications Port Installation Instructions*, publication 1404-IN002A-US-P.

Performance Features

The Powermonitor 3000 Remote I/O performance features include:

- Three baud rates: 57.6k, 115.2k, 230.4k
- Cable lengths up to 3048 meters (10,000 feet)
- Node capacity up to 32 nodes
- Update rates for discretes: 5 msec
- Update rates for block transfers: 50 msec minimum
- Ten discrete inputs
- Two discrete outputs
- Twenty-six block transfer readable data tables
- Thirteen block transfer writeable data tables
- Three sizes of user configurable block transfer readable data tables: 6, 32 and 62 words

Figure 1 Master Module with RS-485 and Remote I/O Communication Card

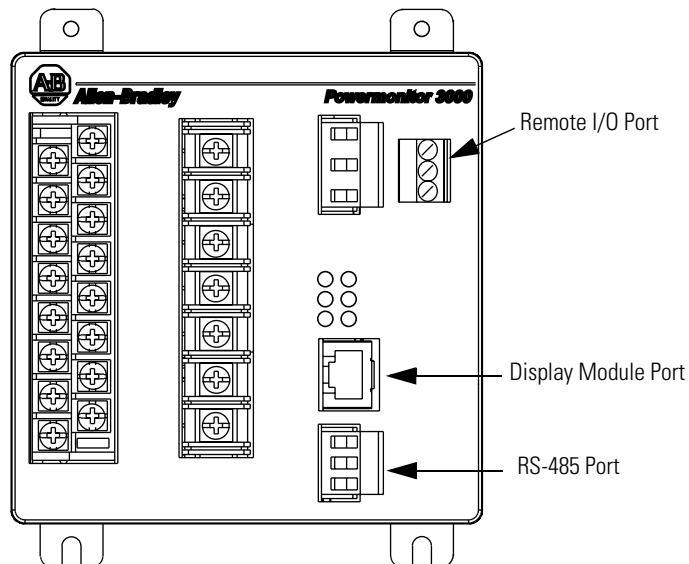

Prevent Electrostatic Discharge

ATTENTION



Electrostatic discharge can damage integrated circuits or semiconductors. Follow these guidelines when you handle the module.

- Touch a grounded object to discharge static potential.
- Wear an approved wriststrap grounding device.
- Do not open the module or attempt to service internal components.
- If available, use a static safe work station.
- When not in use, keep the module in its static shield bag.

Wiring

For information on wire sizes and types for grounding electrical equipment, refer to the *Industrial Automation Wiring and Grounding Guidelines for Noise Immunity*, publication 1770-4.1.

ATTENTION



Special high level isolation is required between units when the possibility of high ground potential differences exist. This may occur when communicating to a unit connected to a power ground mat. Failure to do so can lead to personal injury or death, property damage, or economic loss.

- The communications topology is designed to operate in a daisy-chain topology. Use of the star or bridging method will cause signal distortion unless impedances are matched for each spur. Bridging is not recommended without matching networks.
- To prevent end reflections, each end of the daisy-chain should be terminated in the characteristic impedance for the cable, the baud rate, and frequency used.

Communication Format	Baud Rate	Terminating Resistor
Remote I/O	57.6 to 115.2k	150Ω 1/4W
	230.4k	84Ω 1/4W

- Each end section of cable should have the shield connected to the terminal labeled SHLD. This SHLD ground provides a high-frequency ground, while limiting DC or power line frequencies from flowing down the cable shield.

Table 1 Remote I/O Capabilities Table

Cable Type	Baud Rate	Maximum Distance	Maximum Number of Nodes
Belden™ 9463	57.6 Kbps	3048 m (10,000 ft)	16
Belden 9463	115.2 Kbps	1524 m (5,000 ft)	16
Belden 9463	230.4 Kbps	762 m (2,500 ft)	32

Figure 2 Connecting Powermonitor 3000 to Computer Communications Port

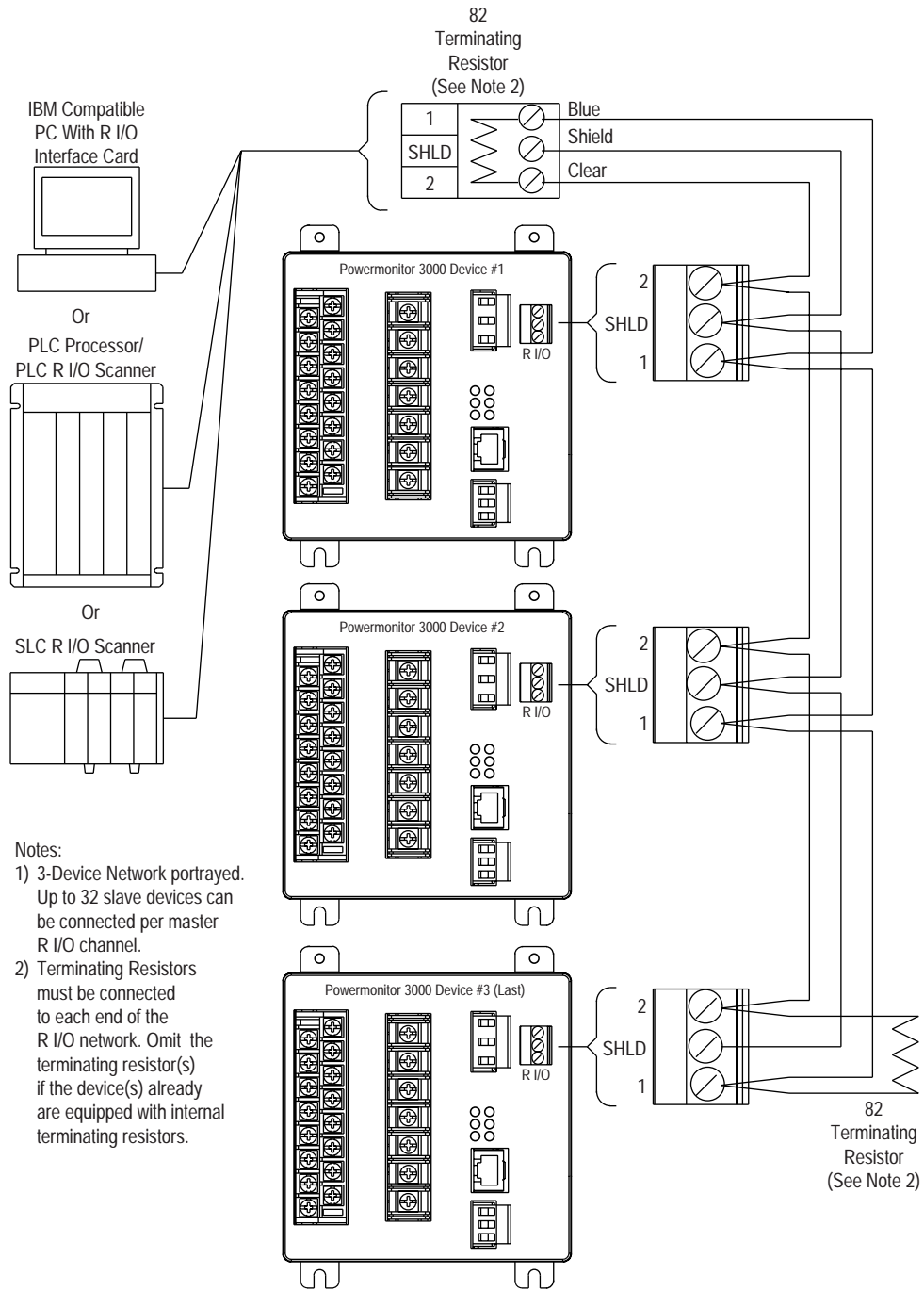

Field Service Considerations

If the module requires service, please contact your nearest Allen-Bradley Sales Office. To minimize your inconvenience, the initial installation should be performed in a manner which makes removal easy.

General Operation

Communication Port Set-Up

All communication port options such as communications rack address, group, last rack and baud rate are listed in Table 3. For help in configuration through the Display Module, refer to *Powermonitor 3000 Base Unit and Display Module Installation Instructions*, publication 1404-IN001A-US-P, Chapter 4.

Indicators

The Powermonitor 3000 is equipped with six light emitting diodes (LED's). See Figure 3.

Figure 3 LED Indicators

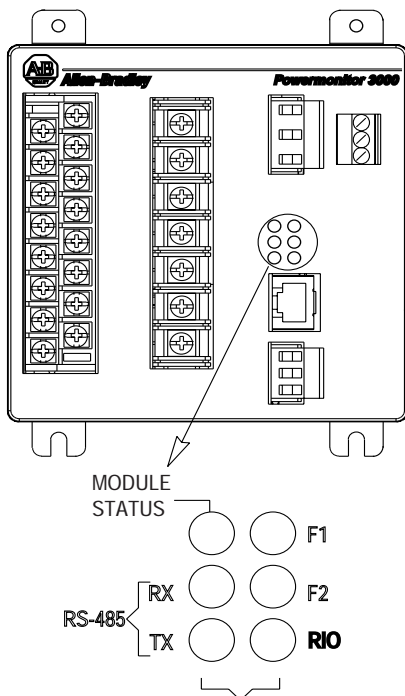

Table 2 LED Indicators

LED	LED Color	LED State and Communications Condition
Module Status	Off	Insufficient power is applied to the control power input for the Powermonitor 3000 to operate
	Solid Red	The device did not pass internal self tests and service is needed
	Solid Green	The device is operating normally
RS-485 RX	Off	The RS-485 bus is idle; no active data is present on the RS-485 bus
	Flashing Green	Active data is present on the RS-485 bus
RS-485 TX	Off	The Powermonitor 3000 is not transmitting any data onto the RS-485
	Flashing Green	The Powermonitor 3000 is transmitting data onto the RS-485
RIO	Off	Communications not established
	Flashing Green	Communications established with errors
	Solid Green	Communications established
F1	Off	Not Used
F2	Off	Not Used

Configuration Items Communication

Table 3 Remote I/O Communication Configuration Items

Parameter	Description	Range	Default	User Setting
R I/O Rack Address	Specifies the logical rack of the communication card.	0 to 63	1	
R I/O Group Number	Determines the group number of the logical rack.	0 = First Quarter 2 = Second Quarter 4 = Third Quarter 6 = Fourth Quarter	0 = First Quarter	
R I/O Last Rack	Defines whether or not the configured rack is the last rack.	0 = No 1 = Yes	0 = No	
R I/O	Specifies the baud rate of the RIO network.	0 = 57.6k 1 = 115k 2 = 230k	0 = 57.6k	

NOTE

Application Considerations:

- Block Transfer Programming**
 Block transfers can only be performed on the first slot of the first module group (group zero) of the logical rack address assigned to this RIO device. Do not select group number 2, 4 or 6 if block transfers are desired with the Powermonitor 3000
- Rack Address Programming**
 When using a rack address of 63, do not use group number 2, 4 or 6.
- Last Rack**
 Set this option if the Powermonitor 3000 is assigned the highest module group number in the rack.

Catalog Number Explanation

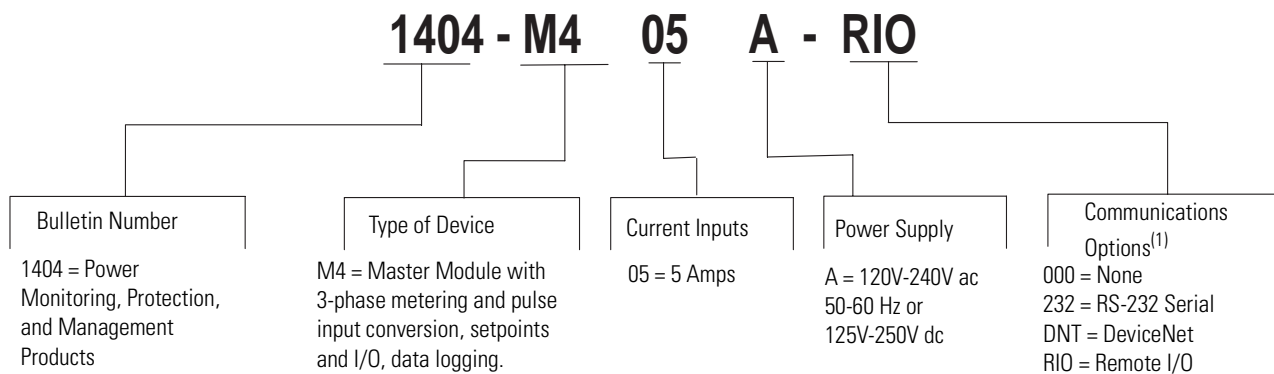

(1) In addition to DF1 via RS-485 port.

Data Tables

Table B.1 Summary of Powermonitor 3000 Data Tables for RS-485 and Remote I/O Communication Protocols

Name of Data Table	PLC Write	PLC Read	R I/O BT # ⁽¹⁾	Number of Words	Refer to
Remote I/O Messaging Discrete Data Provided by Powermonitor 3000 (Master Input Data)	•	•	I/O	-	See Table B.2 on page B-2
Remote I/O Messaging Discrete Data Accepted by Powermonitor 3000 (Master Output Data)	•	•	I/O	-	See Table B.3 on page B-2
Discrete Data (BT# 10)		•	10	6	See Table B.4 on page B-3
Basic Device Configuration (BT# 20)	•	•	20	16	See Table B.5 on page B-3
Date and Time (BT# 12)	•	•	12	8	See Table B.6 on page B-4
Advanced Device Configuration (BT# 26)	•	•	26	22	See Table B.7 on page B-4
RS-485 Communication Configuration (BT# 11)	•	•	11	6	See Table B.8 on page B-6
Remote I/O Communication Configuration (BT# 24)	•	•	24	20	See Table B.9 on page B-7
Metering Voltage, Current and Frequency Results (BT# 38)		•	38	28	See Table B.10 on page B-7
Metering Sequence Voltage and Current Results (BT# 27)		•	27	22	See Table B.11 on page B-8
Metering Power Results (BT# 31)		•	31	26	See Table B.12 on page B-9
Metering Demand Results (BT# 25)		•	25	20	See Table B.13 on page B-10
Metering Power Factor Results (BT# 33)		•	33	26	See Table B.14 on page B-10
Metering Real and Apparent Energy Results (BT# 29)	•	•	29	23	See Table B.15 on page B-11
Metering Reactive Energy and Amp-Hour Results (BT# 30)	•	•	30	23	See Table B.16 on page B-12
Selftest/Diagnostic Results (BT# 36)		•	36	27	See Table B.17 on page B-12
Setpoint Setup/Readback Select and Status (BT# 22)	•	•	22	16	See Table B.18 on page B-14
Trend Log Configuration/Readback Record Select (BT# 34)	•	•	34	26	See Table B.21 on page B-17
Trend Log Data (Large Read) (BT# 48)		•	48	44	See Table B.22 on page B-18
Min/Max Log Configuration/Readback Element Select (BT# 13)	•	•	13	9	See Table B.23 on page B-19
Min/Max Log Results (BT# 28)		•	28	22	See Table B.25 on page B-20
Event Log Configuration/Readback Record Select (BT# 9)	•	•	9	5	See Table B.26 on page B-21
Event Log Results (BT# 21)		•	21	14	See Table B.27 on page B-21
User Configured Table Setup (BT# 35)	•	•	35	26	See Table B.29 on page B-23
User-Configured Table Results (BT# 6, 32, 62)		•	6, 32, 62 ⁽²⁾	6, 32, 62	See Table B.30 on page B-24
Write Error Status (BT# 4)		•	4	2	See Table B.31 on page B-24
Harmonic Analysis Configuration/Readback Data Select (BT# 14)	•	•	14	9	See Table B.32 on page B-25
Harmonic Results; THD, Crest Factor, and more (BT# 23)		•	23	18	See Table B.33 on page B-25

⁽¹⁾ The differences between Remote I/O and the actual data table size are reserved table entries (data table padding).

⁽²⁾ Since Remote I/O protocol does not support partial reads of block transfers, three configurable table were created so that the user can choose which table size best fits the data.

NOTE

With the Powermonitor 3000 configured for Rack 1, starting quarter 1, the two words of discrete data appear in words I:2.8 and I:2.9 of the SLC input data file.

Table B.2 Remote I/O Messaging Discrete Data Provided by Powermonitor 3000 (Master Input Data)

R I/O Word #	Element Name	Range	Default Value	Comment
1	Relay, KYZ and alarm bits	-	-	Bits 0 to 7 = Reserved. Used internally for BT information. Bit 8 = State of the form-C relay (Alarm output #1) 0 = De-energized (normally open contacts are open) and not forced 1 = Energized (normally open contacts are closed) and not forced Bit 9 = Status of the form-C KYZ solid-state output (Alarm output #2) 0 = De-energized (KZ is "open", KY is "closed") and not forced 1 = Energized (KZ is "closed", KY is "open") and not forced Bit 10 = Status of Alarm output #3 Bit 11 = Status of Alarm output #4 Bit 12 = Status of Alarm output #5 Bit 13 = Status of Alarm output #6 Bit 14 = Status of Alarm output #7 Bit 15 = Status of Alarm output #8 For Bits 10 through 15: 0 = Inactive, 1 = Active
2	Status Input Bits	-	-	Bit 00 = State of status input #1 Bit 01 = State of status input #2 Bit 02 through Bit 11 = Reserved, returns a 0. Bit 12 through Bit 14 = Reserved; used internally for BT information Bit 15 = Reserved, returns a 0.

Table B.3 Remote I/O Messaging Discrete Data Accepted by Powermonitor 3000 (Master Output Data)

R I/O Word #	Element Name	Range	Default Value	Comment
1	Relay Control	0 to 1	-	An external R I/O Master device can control this output directly on scans if enabled by the "Force Relay Output" parameter in Table B.7 on page B-4. 0 = De-energize the relay 1 = Energize the relay
2	KYZ Control	0 to 1	-	An external R I/O Master device can control this output directly on scans if enabled by the "Force Solid-State KYZ Output" parameter in Table B.7 on page B-4. 0 = De-energize the KYZ solid-state output 1 = Energize the KYZ solid-state output

Table B.4 Discrete Data (BT# 10)

R I/O Word #	Element Name	Range	Default Value	Comment
1	Relay Output Status	0 to 3	-	Indicates state of the form-C relay 0=De-energized (normally open contacts are open) and not forced 1=Energized (normally open contacts are closed) and not forced 2=Force de-energized 3=Force energized
2	Solid-State KYZ Output Status	0 to 3	-	Indicates status of the form-C KYZ solid-state output 0=De-energized (KZ is open, KY is closed) and not forced 1=Energized (KZ is closed, KY is open) and not forced 2=Force de-energized 3=Force energized
3	Alarm Output Word	0 to FFFF	-	Indicates state of the 16 alarm output flags A 0 in a bit position indicates released, 1 indicates asserted. Bit 0=relay/setpoint output flag 1 Bit 1=KYZ/setpoint output flag 2 Bit 2=setpoint output flag 3 Bit 3 through 15=setpoint output flag 4 through 16
4	Status Inputs State	0 to 3	-	Indicates state of the 2 status inputs Bit 0=status input #1; 0=open, 1=contact closure detected Bit 1=status input #2; 0=open, 1=contact closure detected Bits 2-15=unused (always 0)
5	Status Input #1 Counter	0 to 32767	-	The number of times status input #1 has gone active since last reset of this counter. This count rolls over to 0 after a maximum count of 32767 is reached. This counter can be cleared to 0 (See Table B.7 on page B-4)
6	Status Input #2 Counter	0 to 32767	-	The number of times status input #2 has gone active since last reset of this counter. This count rolls over to 0 after a maximum count of 32767 is reached. This counter can be cleared to 0 (See Table B.7 on page B-4)

Table B.5 Basic Device Configuration (BT# 20)

R I/O Word #	Element Name	Range	Default Value	Comment
1 2	Password	0 to 9999	0	On a write, the correct password is required to change the basic device configuration. On a read, -1 is returned.
3 4	Voltage Mode (Wiring Configuration)	0 to 8	6 = Wye	Should match the external electrical system and how it is wired to the Powermonitor 3000's voltage and current input terminals. Refer to publication 1404-IN001A-US-P for wiring descriptions. 0 = Delta 3 CT 1 = Delta 2 CT 2 = Direct Delta 3 CT 3 = Direct Delta 2 CT 4 = Open Delta 3 CT 5 = Open Delta 2 CT 6 = Wye 7 = Single Phase 8 = Demo
5 6	PT Primary	1.0 to 10,000,000	480.0	The first value of the PT ratio (xxx:xxx) indicating the nominal voltage present at the high end of the transformer. If no transformer is used (for direct connect of up to 347V L-N or 600V L-L), set the PT ratio to any valid 1:1 ratio (480:480, etc).
7 8	PT Secondary	1.0 to 600	480.0	The second value of the PT ratio (xxx:xxx) indicating the nominal voltage present at the low end of the transformer.
9 10	I1/I2/I3 CT Primary	1.0 to 10,000,000	5.0	The first value of the CT ratio (xxx:xxx) indicating the nominal current at the high end of the transformer.
11 12	I1/I2/I3 CT Secondary	1.0 to 5.0	5.0	The second value of the CT ratio (xxx:xxx) indicating the nominal current at the low end of the transformer.
13 14	I4 CT Primary	1.0 to 10,000,000	5.0	The first value of the CT ratio (xxx:xxx) indicating the nominal current at the high end of the transformer.
15 16	I4 CT Secondary	1.0 to 5.0	5.0	The second value of the CT ratio (xxx:xxx) indicating the nominal current at the low end of the transformer.

Table B.6 Date and Time (BT# 12)

R I/O Word #	Element Name	Range	Default Value ⁽²⁾	Comment
1	Password	0 to 9999	0	On a write, the correct password is required to change the basic device configuration. On a read, -1 is returned.
2	Date: Year	1998 to 2097	1999	A write sets the current 4-digit year. A read returns the current 4-digit year.
3	Date: Month	1 to 12	1	A write sets the current month. A read returns the current month. 1=January, 2=February,... 12=December
4	Date: Day	1 to 31 ⁽¹⁾	1	A write sets the current day of the month. A read returns the current day of the month. The internal real-time clock adjusts the date for leap-year.
5	Time: Hour	0 to 23	0	A write sets the current hour. A read returns the current hour. 0=12am, 1=1am,...23=11pm The internal real-time clock does not adjust for daylight savings time.
6	Time: Minute	0 to 59	0	A write sets the minutes. A read returns the current minutes.
7	Time: Seconds	0 to 59	0	A write sets the seconds. A read returns the current seconds.
8	Time: Hundredths of seconds	0 to 99	0	A write sets the hundredths of seconds. A read returns the current hundredths of seconds.

⁽¹⁾ On a write, the maximum value for "day" depends on the values written to "month" and "year".

⁽²⁾ The date and time default values are set if one of the following three conditions occur: When the device is first powered-up at the factory, a device power-up following the depletion of the real-time clock power source, or in the event of an abnormal condition which may cause the real-time clock to contain values which are not in the valid range. The date and time are not set to the default values when "Restore factory defaults" is performed via the Display Module or communications port.

Table B.7 Advanced Device Configuration (BT# 26)

Element #	Element Name	Range	Default Value	Comment
1	Password	0 to 9999	0	On a write, the correct password is required to change configuration data. On a read, -1 is returned.
2	New Password	0 to 9999	-1	A write changes the value of the password for subsequent writes. If you do not wish to change the password, set this to -1. On a read, -1 is always returned.
3	Demand Period Length	-99 to +99	1	Specifies the desired period for a demand calculations. When set from 1 to 99, the internal clock is used to measure the period (in minutes) for both the actual and predicted demand values. When set to 0, an external pulse connected to status input #2 is required to define the period for the actual demand values while disabling the predicted demand values. When set from -1 to -99, an external pulse connected to status input #2 is required to define the period for the actual demand values while using the internal clock for the predicted demand values.
4	Number of Demand Periods	1 to 15	1	Specifies the number of demand periods to average for demand measurement.
5	Predicted Demand Type	0 to 2	0	Indicates the type of predicted demand calculation that is performed. 0=instantaneous, 1=1st order, 2=2nd order
6	KYZ Pulse Output Parameter	0 to 6	0	Indicates which parameter is used to control the KYZ pulse output. 0=Disabled (KYZ output not controlled by an energy parameter) 1=Wh Forward 2=Wh Reverse 3=VARh Forward 4=VARh Reverse 5=Vah 6=Ah
7	KYZ Pulse Output Scale	1 to 32767	10	Defines how many increments of the specified energy parameter must occur before the output is pulsed or transitions. For example, if "Wh" is selected as the "KYZ Pulse Output Parameter", a selection of "1" causes a pulse every 1 Wh (1000 causes a pulse every 1kWh, 5000 causes a pulse every 5kWh, etc.).

Table B.7 Advanced Device Configuration (BT# 26)

Element #	Element Name	Range	Default Value	Comment
8	KYZ Pulse Output Width	0 to 2000	0	Set as 1 to 2000 to indicate the duration of the pulse in milliseconds, or set to 0 for KYZ-style transition output.
9	Relay Pulse Output Parameter	0 to 6	0	Indicates which parameter is used to control the relay pulse output. 0=Disabled (relay output not controlled by an energy parameter) 1=Wh Forward 2=Wh Reverse 3=VARh Forward 4=VARh Reverse 5=Vah 6=Ah
10	Relay Pulse Output Scale	1 to 32767	10	Defines how many increments of the specified energy parameter must occur before the output is pulsed or transitions.
11	Relay Pulse Output Width	0, 40 to 2000	0	Set as 40 to 2000 to indicate the duration of the pulse in milliseconds, or set to 0 for KYZ-style transition output.
12	RMS Resolution	0 to 1	1	0=Nominal; allows for faster update rates. 1=High; provides more accurate RMS results when significant level of harmonics are present.
13	RMS Result Averaging	0 to 1	1	Number of consecutive RMS results to average together. This affects the "average frequency" result in Table B.11 on page B-8. 0=No averaging. Provides the fastest response to signal change. 1=Each RMS result is the average of the last 8 calculations. Useful for providing a more "steady" reading.
14	Frequency Averaging	0 to 1	1	Number of consecutive frequency results to average 0=No averaging; frequency is based on the last cycle calculated 1=Frequency result is the average of the last 8 cycles calculated
15	Restore Factory Default Configuration	0 to 1	0	Set this to 1 to cause all configuration data to be restored to factory default setting, otherwise set this to 0. Note: This overrides any changes to any configuration data in this table during the same write.
16	Clear Status Input Counters	0 to 3	0	Allows you to clear one or both status input counters. 0=Do not clear either counter 1=Clear status input counter #1 2=Clear status input counter #2 3=Clear both status input counters
17	Reserved	0	0	Reserved
18	Force Relay Output	0 to 3	0	Allows forcing of the relay output. This will over-ride any setpoint or pulse output control of the relay until the force is released. 0=No force of relay (release force) 1=Force energize the relay (close the normally open contacts) 2=Force de-energize the relay (open the normally open contacts) 3=Allow DeviceNet or RI/O scanner exclusive control of the relay output.
19	Force Solid-State KYZ Output	0 to 3	0	Allows forcing of the solid-state KYZ output. This over-ride any setpoint or pulse output control of the output until the force is release. 0=No force of solid-state output (release force) 1=Force energize the solid-state output; "close" the normally open KZ "contacts" 2=Force de-energize the solid-state ("open" the normally open contacts) 3=Allow DeviceNet or RI/O scanner exclusive control of the KYZ output

Table B.7 Advanced Device Configuration (BT# 26)

Element #	Element Name	Range	Default Value	Comment
20	Default Relay State in Event of Communication Loss ⁽¹⁾	0 to 3	0	Specifies the action to take on the relay or solid-state output if the output was forced or controlled via a communication port and there was a loss of communication ⁽²⁾ . 0=Last state/resume; Hold the output in its last state during a comm loss and resume the output control when communication recovers. 1=Last state/freeze; Hold the output in its last state during a comm loss and freeze the output in this state when communication recovers. The freeze can be cleared by changing this parameter to last state/resume. 2=De-energize/resume; De-energize the output during communication loss and resume output control when communication recovers. 3=De-energize/freeze; De-energize the output during comm loss and freeze the output in this state when communication recovers. The freeze can be cleared by changing this parameter to De-energize/resume.
21	Default KYZ State in Event of Communication Loss ⁽¹⁾	0 to 3	0	
22	DM Text Scroll Rate	0 to 1	1	Selects the text scroll rate for messages on the Display Module. 0=Slow 1=Fast

- ⁽¹⁾ Safety item. If the relay and/or solid-state KYZ output are used to control a device, the customer must determine which default output state results in the safest condition in the event of a communications loss.
- ⁽²⁾ The definition of “loss of communications” for the purpose of default output state varies based on the protocol. For DF1, the Powermonitor internally flags a loss of communications when it has not received a valid poll, or write within 1 minute.

Table B.8 RS-485 Communication Configuration (BT# 11)

R I/O Word #	Element Name	Range	Default Value	Comment
1	Password	0-9999	0	The correct password is required on a write to change native communication configuration data. Always returns -1 on a read.
2	Protocol	0	0	Selects the communication protocol for the native communications port. 0=DF1 half-duplex slave (Powermonitor 3000 currently only support DF1 half-duplex slave)
3	Delay	0 to 15	2 (10ms)	Indicates the amount of time in milliseconds multiplied by 5 that the powermonitor delays between the reception of an external request and a response. This can be used with slow external devices (such as RF modems).
4	Baud Rate	0-4	3	Communications bit rate 0=1200 baud 1=2400 baud 2=4800 baud 3=9600 baud 4=19200 baud
5	Device Address	0-255	⁽¹⁾	Uniquely identifies a Powermonitor 3000 device on a multi-drop network. The address 0 is typically used by the DF1 master. The address 255 is used by the master for broadcasting to all devices.
6	Data Format	0-1	0	Parity, number of data bits, number of stop bits 0=No parity, 8 data bits, 1 stop bit 1=Even parity, 8 data bits, no stop bits.

- ⁽¹⁾ The default address is the same as the “Device (D)”, which is assigned at the factory and can be found printed on the white label on the side of the master module. The device ID is incremented for each device on the production line. This allows a customer to connect several power monitor devices onto an RS-485 network “right out of the box” and get all of the devices communicating.

Table B.9 Remote I/O Communication Configuration (BT# 24)

R I/O Word #	Element Name	Range	Default Value	Comment
1	Password	0-9999	0	The correct password is required on a write to change Remote I/O configuration data. Always returns -1 on a read.
2	Logical Rack Address	1 to 63	63	Indicates the logical rack address of the power monitor adapter (slave) device on the R I/O network. Rack address 0 is used by the master.
3	Logical Starting Quarter	1 to 4	1	Indicates the starting quarter within the logical rack. 1 = 1st quarter (acts like the first 4 rack slots) 2 = 2nd quarter 3 = 3rd quarter 4 = 4th quarter
4	Last Rack	0 to 1	0	Indicates to the scanner that this device is the last device to be scanned. 0 = No 1 = Yes
5	Baud Rate	0-2	0	Specifies the baud rate of the R I/O network. All devices on the R I/O network need to be configured for the same baud rate. 0 = 57.6k baud (up to 16 nodes, up to 10,000 ft, use 150-Ohm 1/4 W) 1 = 115.2k baud (up to 16 nodes, up to 5,000 ft, use 150-Ohm 1/4 W) 2 = 230.4k baud (up to 32 nodes, up to 2,500 ft, use 82-Ohm 1/4 W)
6	Reserved	0	0	Reserved for future use. On a write, set to 0 for compatibility with future firmware revisions. On a read, these integers always return a 0.
7	Reserved	0	0	
8	Reserved	0	0	
9	Reserved	0	0	
10	Reserved	0	0	
11	Reserved	0	0	
12	Reserved	0	0	
13	Reserved	0	0	
14	Reserved	0	0	
15	Reserved	0	0	
16	Reserved	0	0	
17	Reserved	0	0	
18	Reserved	0	0	
19	Reserved	0	0	
20	Reserved	0	0	

Table B.10 Metering Voltage, Current and Frequency Results (BT# 38)

R I/O Word #	Element Name	Range	Default Value	Comment
1 2	L1 Current	0.0 to 999.9×10^{21}	-	Phase 1 RMS current. Scaled using I1/I2/I3 CT Primary/Secondary ratio to represent the current on the primary side of the I1 CT.
3 4	L2 Current	0.0 to 999.9×10^{21}	-	Phase 2 RMS current.
5 6	L3 Current	0.0 to 999.9×10^{21}	-	Phase 3 RMS current.
7 8	Avg Current	0.0 to 999.9×10^{21}	-	Average of phase 1, phase 2, and phase 3 RMS current.
9 10	L1-N Voltage	0.0 to 999.9×10^{21}	--	Phase 1 to neutral RMS voltage (returns 0 for delta wiring modes). Scaled using PT Primary/Secondary ratio to represent the voltage on the primary side of the PT.
11 12	L2-N Voltage	0.0 to 999.9×10^{21}	-	Phase 2 to neutral RMS voltage (returns 0 for delta wiring modes).
13 14	L3-N Voltage	0.0 to 999.9×10^{21}	-	Phase 3 to neutral RMS voltage (returns 0 for delta and single phase wiring modes).

Table B.10 Metering Voltage, Current and Frequency Results (BT# 38)

R I/O Word #	Element Name	Range	Default Value	Comment
15 16	Avg L-N Voltage	0.0 to 999.9x10 ²¹	-	Average of phase 1 to neutral, phase 2 to neutral, and phase 3 to neutral RMS voltages in all wiring modes except single phase (where this parameter is the average of line 1 to neutral and line 2 to neutral).
17 18	L1-L2 Voltage	0.0 to 999.9x10 ²¹	-	RMS line to line voltage between phase 1 and 2.
19 20	L2-L3 Voltage	0.0 to 999.9x10 ²¹	-	RMS line to line voltage between phase 2 and 3.
21 22	L3-L1 Voltage	0.0 to 999.9x10 ²¹	-	RMS line to line voltage between phase 3 and 1.
23 24	Avg L-L Voltage	0.0 to 999.9x10 ²¹	-	Average RMS line to line voltage between phase 1, 2 and 3.
25 26	Frequency, Last Cycle	40.0 to 75.0	-	Frequency of the last cycle measured. Returns 0 if below 40Hz or if voltage magnitude on all 3 voltage inputs too low. Returns 999.0 if above 75Hz.
27 28	Metering Iteration	0 to 32767	-	Increments by 1 for each new iteration of metering results. Counts from 0 to 32767, then rolls over to 0. Can be used by an external device to determine if the current read of this table contains newer metering data than the previous read of this table.

Table B.11 Metering Sequence Voltage and Current Results (BT# 27)

R I/O Word #	Element Name	Range	Default Value	Comment
1 2	I4 Current	0.0 to 999.9x10 ²¹	-	RMNS current scaled using I4 CT primary/secondary ratio to represent the current on primary side of the I4 CT. This is the zero-sequence current on a Wye system when neutral current is connected to the I4 current input and is the zero-sequence current in Delta systems when an external zero sequence transformer is connected to the I4 input.
3 4	Positive Sequence Current	0.0 to 999.9x10 ²¹	-	Magnitude of positive sequence current in a 3-phase system. Represents that portion of the current supplied to a rotating load that is capable of doing work. See publication 1403-1.0.2 for additional information.
5 6	Negative Sequence Current	0.0 to 999.9x10 ²¹	-	Magnitude of a negative sequence current in a 3-phase system. Represents that portion of the current supplied to a rotating load that result in system losses due to the unbalance.
7 8	% Current Unbalance	0.0 to 100.0	-	The ratio between the negative and positive current sequence in a 3-phase system. This is the most accurate measurement of current unbalance because it takes into account the magnitude of the individual currents and the relative phase displacement.
9 10	Positive Sequence Voltage	0.0 to 999.9x10 ²¹	-	Magnitude of positive sequence voltage in a 3-phase system. Represents that portion of the voltage supplied to a rotating load that is capable of doing work.
11 12	Negative Sequence Voltage	0.0 to 999.9x10 ²¹	-	Magnitude of negative sequence voltage in a 3-phase system. Represents that portion of the voltage supplied to a rotating load that result in system losses due to the unbalance.
13 14	% Voltage Unbalance	0.0 to 100.0	-	The ratio between the negative and positive voltage sequence in a 3-phase system. This is the most accurate measurement of voltage unbalance because is takes into account the magnitude of the individual voltages and the relative phase displacement.
15 16	Phase Rotation	0 to 2	-	The phase rotation of a 3-phase system. 0=No rotation 1=ABC rotation 2=ACB rotation
17 18	Average Frequency	40.0 to 75.0	-	An average of the last (x) frequency calculations from one of the three voltage inputs. The number of consecutive 1-cycle frequency results that are averaged depend on the "Frequency averaging" parameter in Table B.7 on page B-4. Returns 0 if below 40Hz or if voltage magnitude on all three voltage inputs too low. Returns 999.0 if above 75Hz.

Table B.11 Metering Sequence Voltage and Current Results (BT# 27)

R I/O Word #	Element Name	Range	Default Value	Comment
19 20	Frequency Source	0 to 2	-	Indicates which voltage channel was used for frequency calculation. The Powermonitor automatically switches to another voltage input in the event of a phase loss and continues to provide metering results. 0=V1 1=V2 2=V3
21 22	Metering Iteration	0 to 32767	-	Increments by 1 for each new iteration of metering results. Counts from 0 to 32767, then rolls over to 0. Can be used by an external device to determine if the current read of this table contains newer metering data than the previous read of this table.

Table B.12 Metering Power Results (BT# 31)

R I/O Word #	Element Name	Range	Default Value	Comment
1 2	L1 Real Power	0.0 to 999.9x10 ²¹	-	Power of phase 1 signed to show direction.
3 4	L2 Real Power	0.0 to 999.9x10 ²¹	-	Power of phase 2 signed to show direction.
5 6	L3 Real Power	0.0 to 999.9x10 ²¹	-	Power of phase 3 signed to show direction. Returns 0 in single phase.
7 8	Total Real Power	0.0 to 999.9x10 ²¹	-	Total power of phase 1, 2, and 3 signed to show direction.
9 10	L1 Reactive Power	0.0 to 999.9x10 ²¹	-	Reactive power of phase 1 signed to show direction.
11 12	L2 Reactive Power	0.0 to 999.9x10 ²¹	-	Reactive power of phase 2 signed to show direction.
13 14	L3 Reactive Power	0.0 to 999.9x10 ²¹	-	Reactive power of phase 3 signed to show direction. Returns 0 in single phase mode.
15 16	Total Reactive Power	0.0 to 999.9x10 ²¹	-	Total reactive power of phase 1, 2, and 3 signed to show direction.
17 18	L1 Apparent Power	0.0 to 999.9x10 ²¹	-	Apparent power of phase 1.
19 20	L2 Apparent Power	0.0 to 999.9x10 ²¹	-	Apparent power of phase 2.
21 22	L3 Apparent Power	0.0 to 999.9x10 ²¹	-	Apparent power of phase 3. Returns 0 in single phase mode.
23 24	Total Apparent Power	0.0 to 999.9x10 ²¹	-	Total apparent power of phase 1, 2, and 3 (phase 1 and 2 in single phase mode).
25 26	Metering Iteration	0 to 32767	-	Increments by 1 for each new iteration of metering results. Counts from 0 to 32767, then rolls over to 0. Can be used by an external device to determine if the current read of this table contains newer metering data than the previous read of this table.

Table B.13 Metering Demand Results (BT# 25)

R I/O Word #	Element Name	Range	Default Value	Comment
1 2	Demand Current	0.0 to 999.9x10 ²¹	-	The calculated demand for average current.
3 4	Demand Power	0.0 to 999.9x10 ²¹	-	The calculated demand for total real power.
5 6	Demand Reactive Power	0.0 to 999.9x10 ²¹	-	The calculated demand for total reactive power.
7 8	Demand Apparent Power	0.0 to 999.9x10 ²¹	-	The calculated demand for total apparent power.
9 10	Projected Demand I	0.0 to 999.9x10 ²¹	-	Projected demand for average current. The method of projection is determined by the "Predicted Demand Type" element in Table B.7 on page B-4.
11 12	Projected Demand W	0.0 to 999.9x10 ²¹	-	Projected demand for total real power. The method of projection is determined by the "Predicted Demand Type" element in Table B.7 on page B-4.
13 14	Projected Demand VAR	0.0 to 999.9x10 ²¹	-	Projected demand for total reactive power. The method of projection is determined by the "Predicted Demand Type" element in Table B.7 on page B-4.
15 16	Projected Demand VA	0.0 to 999.9x10 ²¹	-	Projected demand for total apparent power. The method of projection is determined by the "Predicted Demand Type" element in Table B.7 on page B-4.
17 18	Elapsed Demand Period Time	0.0 to 99.0	-	The amount of time (in minutes) that has elapsed within the current demand period.
19 20	Metering Iteration	0 to 32767	-	Increments by 1 for each new iteration of metering results. Counts from 0 32767, then rolls over to 0. Can be used by an external device to determine if the current read of this table contains newer metering data than the previous read of this table.

Table B.14 Metering Power Factor Results (BT# 33)

R I/O Word #	Element Name	Range	Default Value	Comment
1 2	L1 True Power Factor	-100 to 100	-	The ratio between the power and apparent power for phase 1 (in %). This value is signed to show lead (+) or lag (-).
3 4	L2 True Power Factor	-100 to 100	-	The ratio between the power and apparent power for phase 2 (in %). This value is signed to show lead (+) or lag (-).
5 6	L3 True Power Factor	-100 to 100	-	The ratio between the power and apparent power for phase 3 (in %). This value is signed to show lead (+) or lag (-).
7 8	3-Phase True Power Factor	-100 to 100	-	The ratio between the total true power and total apparent power (in %). This value is signed to show lead (+) or lag (-).
9 10	L1 Displacement Power Factor	-100 to 100	-	The cosine of the difference between the phase angle of the fundamental voltage and current for phase 1 (in %). This value is signed to show lead (+) or lag (-).
11 12	L2 Displacement Power Factor	-100 to 100	-	The cosine of the difference between the phase angle of the fundamental voltage and current for phase 2 (in %). This value is signed to show lead (+) or lag (-).
13 14	L3 Displacement Power Factor	-100 to 100	-	The cosine of the difference between the phase angle of the fundamental voltage and current for phase 3 (in %). This value is signed to show lead (+) or lag (-).
15 16	3-Phase Displacement Power Factor	-100 to 100	-	The cosine of the difference between the phase angle between the phase angle of the fundamental voltage and current for phase 1, 2, and 3 (in %). This value is signed to show lead (+) or lag (-).
17 18	L1 Distortion Power Factor	0 to 100	-	The ratio between the magnitude of the fundamental and the sum of the magnitudes for all of the current harmonics for phase 1 (in %).
19 20	L2 Distortion Power Factor	0 to 100	-	The ratio between the magnitude of the fundamental and the sum of the magnitudes for all of the current harmonics for phase 2 (in %).

Table B.14 Metering Power Factor Results (BT# 33)

R I/O Word #	Element Name	Range	Default Value	Comment
21 22	L3 Distortion Power Factor	0 to 100	-	The ratio between the magnitude of the fundamental and the sum of the magnitudes for all of the current harmonics for phase 3 (in %).
23 24	3-Phase Distortion Power Factor	-100 to 100	-	The ratio between the magnitude of the fundamental and the sum of the magnitudes for all of the current harmonics for phase 1, 2, and 3 (in %).
25 26	Metering iteration	0 to 32767	-	Increments by 1 for each iteration of metering results. Counts from 0 to 32767, then rolls over to 0. Can be used by an external device to determine if the current read of this table contains newer metering data than the previous read of this table.

Table B.15 Metering Real and Apparent Energy Results (BT# 29)

R I/O Word #	Element Name	Range	Default Value	Comment
1	Password	0 to 9999	0	The correct password is required during a write to clear or preset one or more of the energy counters. Read always returns -1.
2	Parameter select	0 to 7 (bitfield)	0	Read always returns 0. On a write, this selects which parameter(s) are affected: If bit 0 = 1, a valid value written into kWh forward is saved. If bit 1 = 1, a valid value written into kWh reverse is saved. If bit 2 = 1, a valid value written into kVAh is saved. Set all three bits (a value of 7) to clear/set all three results at the same time.
3 4 5 6 7	kWh Forward ### x 10 ⁹ ### x 10 ⁶ ### x 10 ³ ### x 10 ⁰ ### x 10 ⁻³	0 to 999	0	Accumulated real energy forward. (15 digits, 3 per word) A read returns amount of real energy in the forward direction. A write clears (or presets) this result.
8 9 10 11 12	kWh Reverse ### x 10 ⁹ ### x 10 ⁶ ### x 10 ³ ### x 10 ⁰ ### x 10 ⁻³	0 to -999	0	Accumulated real energy reverse. (15 digits, 3 per word) A read returns amount of real energy in the reverse direction. A write clears (or presets) this result.
13 14 15 16 17	kWh Net ### x 10 ⁹ ### x 10 ⁶ ### x 10 ³ ### x 10 ⁰ ### x 10 ⁻³	-999 to 999	0	Net real energy. This is the sum of kWh forward and kWh reverse. (15 digits, 3 per word) A positive value indicates real energy forward. A negative value indicates real energy reverse. A write has no effect.
18 19 20 21 22	kVAh ### x 10 ⁹ ### x 10 ⁶ ### x 10 ³ ### x 10 ⁰ ### x 10 ⁻³	0 to 999	0	Accumulated apparent energy. (15 digits, 3 per word) A write clears (or presets) this result.
23	Metering Iteration	0 to 32767	0	Increments by 1 for each new iteration of metering results. Counts from 0 to 32767, then rolls over to 0. Can be used by an external device to determine if the current read of this table contains newer metering data than the previous read of this table.

Table B.16 Metering Reactive Energy and Amp-Hour Results (BT# 30)

R I/O Word #	Element Name	Range	Default Value	Comment
1	Password	0 to 9999	0	The correct password is required during a write to clear or preset one or more of the energy counters. Read always returns -1.
2	Parameter select	0 to 3	0	Read always returns 0. On a write, this selects which parameter(s) are affected: If bit 0 = 1, a valid value written into kVARh forward is saved. If bit 1 = 1, a valid value written into kVARh reverse is saved. If bit 2 = 1, a valid value written into Ah is saved. Set all 3 bits (a value of 7) to clear/set all three results at the same time.
3	kVARh Forward ### x 10 ⁹	0 to 999	0	Accumulated reactive energy forward. (15 digits, 3 per word) A read returns amount of reactive energy in the forward direction. A write clears (or presets) this result.
4	### x 10 ⁶			
5	### x 10 ³			
6	### x 10 ⁰			
7	### x 10 ⁻³			
8	kVARh Reverse ### x 10 ⁹	0 to -999	0	Accumulated reactive energy reverse. (15 digits, 3 per word) A read returns amount of reactive energy in the reverse direction. A write clears (or presets) this result.
9	### x 10 ⁶			
10	### x 10 ³			
11	### x 10 ⁰			
12	### x 10 ⁻³			
13	kVARh Net ### x 10 ⁹	-999 to 999	0	Net reactive energy. This is the sum of kVARh forward and kVARh reverse. (15 digits, 3 per word) A positive value indicates reactive energy forward. A negative value indicates reactive energy reverse. A write has no effect.
14	### x 10 ⁶			
15	### x 10 ³			
16	### x 10 ⁰			
17	### x 10 ⁻³			
18	Ah ### x 10 ⁹	0 to 999	0	Accumulated amp-hours. (15 digits, 3 per word) A write clears (or presets) this result.
19	### x 10 ⁶			
20	### x 10 ³			
21	### x 10 ⁰			
22	### x 10 ⁻³			
23	Metering Iteration	0 to 32767	0	Increments by 1 for each new iteration of metering results. Counts from 0 to 32767, then rolls over to 0. Can be used by an external device to determine if the current read of this table contains newer metering data than the previous read of this table.

Table B.17 Selftest/Diagnostic Results (BT# 36)

R I/O Word #	Element Name	Range	Default Value	Comment
1	Bulletin Number	1404	-	Always returns 1404.
2	Series	0 to 8	-	Indicates the series of the product (can also be found printed on the label). 0=A 1=B
3	Overall Status	-	-	0 indicates healthy status (normal operation).
4	ASIC Status	-	-	0 indicates healthy status (normal operation).
5	Data FLASH Status	-	-	0 indicates healthy status (normal operation).
6	Real-Time Clock Status	-	-	0 indicates healthy status (normal operation).
7	RTC NVRAM Status	-	-	0 indicates healthy status (normal operation). Non-zero indicates corruption of non-volatile memory. This does not cause product to shutdown. The error is cleared on a reset/power cycle. If this error is detected, date/time, and energy values are reset.

Table B.17 Selftest/Diagnostic Results (BT# 36)

R I/O Word #	Element Name	Range	Default Value	Comment
8	Option Communication Status	-	-	0 indicates healthy status (normal operation). Also returns 0 if no optional communication present.
9	Display Module Status	-	-	0 indicates healthy status (normal operation). Also returns 0 if no display module is connected.
10	Watchdog Status	-	-	0 indicates healthy status (normal operation).
11	VCO Lock Status	-	-	Indicates the status of the voltage-controlled oscillator within the processor located on the master module digital board. 0 = Healthy status (normal operation) 1 = Could not lock-in.
12	Reserved	-	-	Reserved.
13	Application FRN	0 to 9999	-	Firmware revision number of the main application code which resides in a FLASH part on the master module digital board. 100 indicates V1.00, 103 indicates V1.03, etc.
14	Boot Code FRN	0 to 9999	-	Firmware revision number of the boot loader code which resides in a FLASH part on the master module digital board. 100 indicates V1.00, 101 indicates V1.01, etc.
15	ASIC Build Number	0 to 9999	-	Revision number of the "code" which was used to fabricate the ASIC.
16	Optional Communication FRN	0 to 9999	-	Revision of the firmware that resides on the optional communications card (DeviceNet). Returns 0 if no optional communication is present or if the communication card does not contain firmware (RS-232, Remote I/O).
17	Display Module FRN	0 to 9999	-	Revision of the firmware that resides in the Display Module. 104 indicates V1.04, 105 indicates V1.05, etc. Returns 0 if no display module connected.
18	Reserved	0 to 9999	-	Reserved
19	Digital Board Revision	0 to 7	-	Revision of the digital board within the master module. 0 = 02A 1 = 03A, etc.
20	Analog Board Revision	0 to 7	-	Revision of the analog board within the master module. 0 = 02A 1 = 03A, etc.
21	Optional Communication Board Revision	0 to 9999	-	Revision of the optional communications board. Returns 0 if no optional communication board is present.
22	Reserved	0 to 9999	-	Reserved.
23	MM Device ID	0 to 255	-	A unique number assigned to a device at time it is manufactured. This number is used by some communication options to form a factory default network address. This allows multiple devices to be connected to a network "out of the box" and not conflict. The device ID cannot be changed.
24	Reserved	0	-	Reserved
25	Display Module Type	0 to 1	-	Indicates the type of display module connected to the master module. 00 = No display module connected. 01 = 1404-DM connected to master module.
26	Optional Communication Type	See Comment	-	Indicates the type of optional communication card contained in the master module. 00 = No optional communication card present (native RS-485 only) 01 or 09 = RS-232 with handshaking 40 = DeviceNet 02 = Remote I/O
27	Reserved	0	-	Reserved

Table B.18 Setpoint Setup/Readback Select and Status (BT# 22)

R I/O Word #	Element Name	Range	Default Value	Comment
1	Password	0 to 9999	-	Correct password is required to configure a setpoint, but is not required to select setpoint configuration/result information to be read back. If you wish to select setpoint information to readback without performing a write of setpoint configuration data, set password to -1
2	Setpoint Number	1 to 10	-	On a write, this selects the setpoint configuration data to be returned during the next read... and if the password is not set to -1, this also indicates the setpoint number associated with the configuration data being written. On a read, this indicates the setpoint number associated with the configuration and result information is being returned.
3	Readback Mode	0 to 1	0	Selects the readback mode for this table. 0 = Automatically increments the setpoint number after a read of this table (allows for all setpoint information to be read with successive reads). 1 = Setpoint number not incremented after a read (allows for monitoring of information on an individual setpoint with successive reads). DeviceNet does not support the "auto-increment" mode (this value is ignored for the DeviceNet port and always acts as if set to 1).
4	Setpoint Type	0 to 44	0	Indicates which parameter value is being evaluated against high and low limits. See Table B.19 on page B-15 for a list of setpoint types
5	Evaluation Condition	0 to 5	0	Indicates how the setpoint type is evaluated against the limit(s). 0 = Over high limit for positive values. 1 = Over high limit for negative values. 2 = Under low limit for positive values. 3 = Under low limit for negative values. 4 = Equal to high limit (low limit not used). 5 = Not equal to high limit (low limit not used).
6	High Limit Integer	0 to 9999	0	The magnitude of the evaluated parameter must remain above this value for the specified action delay to activate an "over" setpoint. The magnitude of the evaluated parameter must remain above this value for the specified release delay to de-activate an "under" setpoint. High limit = integer x 10 ^{exponent} Example: If Integer = 1350 and exponent = 1, then high limit value = 1,350 x 10 ¹ = 13,500.
7	High Limit Exponent	0 to 21	0	
8	Low Limit Integer	0 to 9999	0	The magnitude of the evaluated parameter must remain below this value for the specified release delay to de-activate an "over" setpoint. The magnitude of the evaluated parameter must remain below this value for the specified action delay to activate an "under" setpoint. Low limit = integer x 10 ^{exponent} Example: If Integer = 1350 and exponent = 1, then high limit value = 1,350 x 10 ¹ = 13,500.
9	Low Limit Exponent	0 to 21	0	
10	Action Delay	0 to 3600	0	Specifies the amount of time in seconds that the setpoint limit must be at before the output action is taken.
11	Release Delay	0 to 3600	0	Specifies the amount of time in seconds that the setpoint parameter must sustain the evaluation criteria before the output action is taken.
12	Output Action	0 to 32	0	Specifies the output action taken when the setpoint conditions have been met. See Table B.20 on page B-16 for a list of setpoint output actions.
13	Status	0 to 1	0	Indicates the current status of this setpoint. 0 = not triggered 1 = triggered
14	Accumulated Time Integer	0 to 9999	-	The total accumulated time (in seconds) that the setpoint was triggered. Accumulated time - integer x 10 ^{exponent} Example: If integer = 326 and exponent = -1, then Accumulated time = 326 x 10 ⁻¹ =32.6 seconds.
15	Accumulated Time Exponent	-1 to 21	-	
16	Clear Time Accumulator Command	0 to 1	0	Write a 1 to clear the time accumulator for this setpoint. Write a 0 to leave the accumulated time for this setpoint unaffected. On a read, always returns a 0.

Table B.19 List of Setpoint Types

Element #	Element Name	Comment
1	Not used	Disables the setpoint
2	Voltage ⁽¹⁾	See Table B.10, "Metering Voltage, Current and Frequency Results (BT# 38)," on page B-7
3	Current ⁽¹⁾	See Table B.10, "Metering Voltage, Current and Frequency Results (BT# 38)," on page B-7
4	Voltage Unbalance	See Table B.11, "Metering Sequence Voltage and Current Results (BT# 27)," on page B-8
5	Current Unbalance	See Table B.11, "Metering Sequence Voltage and Current Results (BT# 27)," on page B-8
6	Neutral Current	See Table B.11, "Metering Sequence Voltage and Current Results (BT# 27)," on page B-8
7	KW	See Table B.12, "Metering Power Results (BT# 31)," on page B-9
8	KVAR	See Table B.12, "Metering Power Results (BT# 31)," on page B-9
9	KVA	See Table B.12, "Metering Power Results (BT# 31)," on page B-9
10	Total True PF	See Table B.14, "Metering Power Factor Results (BT# 33)," on page B-10
11	Total Disp PF	See Table B.14, "Metering Power Factor Results (BT# 33)," on page B-10
12	Total Dist PF	See Table B.14, "Metering Power Factor Results (BT# 33)," on page B-10
13	KW Demand	See Table B.13, "Metering Demand Results (BT# 25)," on page B-10
14	KVAR Demand	See Table B.13, "Metering Demand Results (BT# 25)," on page B-10
15	KVA Demand	See Table B.13, "Metering Demand Results (BT# 25)," on page B-10
16	Amp Demand	See Table B.13, "Metering Demand Results (BT# 25)," on page B-10
17	Projected KW Demand	See Table B.13, "Metering Demand Results (BT# 25)," on page B-10
18	Projected KVAR Demand	See Table B.13, "Metering Demand Results (BT# 25)," on page B-10
19	Projected KVA Demand	See Table B.13, "Metering Demand Results (BT# 25)," on page B-10
20	Projected KVA Demand	See Table B.13, "Metering Demand Results (BT# 25)," on page B-10
21	Frequency	See Table B.10, "Metering Voltage, Current and Frequency Results (BT# 38)," on page B-7
22	Phase Rotation	See Table B.11, "Metering Sequence Voltage and Current Results (BT# 27)," on page B-8
23	Crest Factor Voltage	See Table B.33, "Harmonic Results; THD, Crest Factor, and more (BT# 23)," on page B-25
24	Crest Factor Current	See Table B.33, "Harmonic Results; THD, Crest Factor, and more (BT# 23)," on page B-25
25	Crest Factor I	See Table B.33, "Harmonic Results; THD, Crest Factor, and more (BT# 23)," on page B-25
26	IEEE THD Voltage ⁽¹⁾	See Table B.33, "Harmonic Results; THD, Crest Factor, and more (BT# 23)," on page B-25
27	IEEE THD Current ⁽¹⁾	See Table B.33, "Harmonic Results; THD, Crest Factor, and more (BT# 23)," on page B-25
28	IEEE THD I4	See Table B.33, "Harmonic Results; THD, Crest Factor, and more (BT# 23)," on page B-25
29	IEC THD Voltage ⁽¹⁾	See Table B.33, "Harmonic Results; THD, Crest Factor, and more (BT# 23)," on page B-25
30	IEC THD Current ⁽¹⁾	See Table B.33, "Harmonic Results; THD, Crest Factor, and more (BT# 23)," on page B-25
31	IEC THD I4	See Table B.33, "Harmonic Results; THD, Crest Factor, and more (BT# 23)," on page B-25
32	Status Input 1	See Table B.4, "Discrete Data (BT# 10)," on page B-3
33	Status Input 2	See Table B.4, "Discrete Data (BT# 10)," on page B-3
34	Any Status Input ⁽¹⁾	See Table B.4, "Discrete Data (BT# 10)," on page B-3
35	Setpoint #1 Time Accumulator	See Table B.20, "Setpoint Output Actions," on page B-16
36	Setpoint #2 Time Accumulator	See Table B.20, "Setpoint Output Actions," on page B-16
37	Setpoint #3 Time Accumulator	See Table B.20, "Setpoint Output Actions," on page B-16
38	Setpoint #4 Time Accumulator	See Table B.20, "Setpoint Output Actions," on page B-16
39	Setpoint #5 Time Accumulator	See Table B.20, "Setpoint Output Actions," on page B-16
40	Setpoint #6 Time Accumulator	See Table B.20, "Setpoint Output Actions," on page B-16
41	Setpoint #7 Time Accumulator	See Table B.20, "Setpoint Output Actions," on page B-16
42	Setpoint #8 Time Accumulator	See Table B.20, "Setpoint Output Actions," on page B-16
43	Setpoint #9 Time Accumulator	See Table B.20, "Setpoint Output Actions," on page B-16
44	Setpoint #10 Time Accumulator	See Table B.20, "Setpoint Output Actions," on page B-16

⁽¹⁾ For an "over" setpoint evaluation, the magnitude of any one of the phases over the high limit triggers the output action, but the magnitude of all phases must drop below the low limit for the setpoint to release. For "under" setpoint evaluation, the magnitude of any one of the phases under the low limit triggers the output action, but the magnitude of all phases must rise above the high limit to release the setpoint.

Table B.20 Setpoint Output Actions

Element #	Element Name	Comment
0	None	No output action is taken when the setpoint is asserted, however it is still recorded into the even log and status of the assertion can be detected by reading the "setpoint status" parameter via Table B.18 on page B-14 or Table B.30 on page B-24.
1	Energize Relay (and alarm flag 1)	Energize the relay and set a bit in the output alarm word. See Table B.4 on page B-3 for more information on the relay and alarm output word.
2	Energize KYZ (and alarm flag 2)	energize the solid-state KYZ output and set a bit in the alarm output word.
3	Set Alarm Flag 3	Set a bit (flag) in the alarm output word. Occurrence of the setpoint can be easily detected by an external program by reading the alarm word from Table B.4 on page B-3.
4	Set Alarm Flag 4	
5	Set Alarm Flag 5	
6	Set Alarm Flag 6	
7	Set Alarm Flag 7	
8	Set Alarm Flag 8	
9	Set Alarm Flag 9	
10	Set Alarm Flag 10	
11	Set Alarm Flag 11	
12	Set Alarm Flag 12	
13	Set Alarm Flag 13	
14	Set Alarm Flag 14	
15	Set Alarm Flag 15	
16	Set Alarm Flag 16	
17	Save a Trend Log Record	Causes a record to be recorded immediately into the trend log.
18	Clear kWh Result	Clears the kWh result.
19	Clear kVARh Result	Clears the kVARh result.
20	Clear kVAh Result	Clears the kVAh result.
21	Clear Ah Result	Clears the Ah result.
22	Clear all Energy Results	Clears all energy results (kWh, kVARh, kVAh, Ah)
23	Clear Setpoint #1 Time Accumulator	Clears the time accumulator associated with setpoint #1.
24	Clear Setpoint #2 Time Accumulator	Clears the time accumulator associated with setpoint #2.
25	Clear Setpoint #3 Time Accumulator	Clears the time accumulator associated with setpoint #3.
26	Clear Setpoint #4 Time Accumulator	Clears the time accumulator associated with setpoint #4.
27	Clear Setpoint #5 Time Accumulator	Clears the time accumulator associated with setpoint #5.
28	Clear Setpoint #6 Time Accumulator	Clears the time accumulator associated with setpoint #6.
29	Clear Setpoint #7 Time Accumulator	Clears the time accumulator associated with setpoint #7.
30	Clear Setpoint #8 Time Accumulator	Clears the time accumulator associated with setpoint #8.
31	Clear Setpoint #9 Time Accumulator	Clears the time accumulator associated with setpoint #9.
32	Clear Setpoint #10 Time Accumulator	Clears the time accumulator associated with setpoint #10.

Table B.21 Trend Log Configuration/Readback Record Select (BT# 34)

R I/O Word #	Element Name	Range	Default Value	Comment
1	Password	0 to 9999	-	On a write, the correct password is required to configure/reconfigure trend log functionality, but not required to select a trend log record to be read back. If you are only selecting a trend log record to be read back, set password to -1. On a read, this returns -1.
2	Record Number to Read x 1000	0 to 999	-	On a write, these two words indicate the next record to be read back on a subsequent read of Table B.22. Examples: To read record #1, set the first word to 0 and the second word to 1. To read record #2,345 set the first word to 2 and the second word to 345. The actual range of record numbers that can be requested is based on the number of records that are currently contained in the trend log. On a read, these two integers return the value that was previously written.
3	Record Number to Read x 1	1 to 999	-	
4	Readback Mode	0 to 1	0	Selects the readback mode for Table B.22 "Trend Log Data (Large Read) (BT# 48)". 0 = Automatically increment the record number after a read of Table B.22. 1 = Points to same record after a read of Table B.22.
5	Logging Interval	0 to 3600	900 (15 Min)	Selects how often a record is logged (in seconds). A value of 0 disables periodic logging of records, however a setpoint can still be used to trigger logging of a record. Changing the logging interval does not clear the trend log.
6	Logging Mode	0 to 1	0	Selects how records are saved in the trend log. 0 = Overwrite: When the log is full, a new record is logged and the oldest record is lost. 1 = Fill and hold: Records are logged until the log is full, then logging stops.
7	Clear Trend Log Command	0 to 1	0	On a write, a value of 1 clears the trend log. A value of 0 has no effect on the trend log. On a read, this always returns 0.
8	Total Records Logged Record Number x 1000	0 to 999	-	Indicates total number of records currently contained in the trend log. # records = word 1 x 1000 + word 2 Example: If word 1 = 23 and word 2 = 183, then # records = 23,183
9	Total Records Logged Record Number x 1	0 to 999	-	
10	Reserved	0	-	Reserved for future use. For compatibility with future firmware, always write a 0 here. On a read, this returns 0.
11	Parameter #1 Selection	0 to 294	122 kWh net	Selects the first parameter logged into each record. See Table B.34 for a list of parameters to choose from. A value of 0 selects no parameter. The number of parameters in a record is determined by the last parameter selection that contains a non-zero value. The trend log is cleared when any of the parameter selections are changed.
12	Parameter #2 Selection	0 to 294	126 kVARh net	Selects the 2nd parameter logged into each record.
13	Parameter #3 Selection	0 to 294	100 Demand W	Selects the 3rd parameter logged into each record.
14	Parameter #4 Selection	0 to 294		Selects the 4th parameter logged into each record.
15	Parameter #5 Selection	0 to 294		Selects the 5th parameter logged into each record.
16	Parameter #6 Selection	0 to 294		Selects the 6th parameter logged into each record.
17	Parameter #7 Selection	0 to 294		Selects the 7th parameter logged into each record.
18	Parameter #8 Selection	0 to 294		Selects the 8th parameter logged into each record.
19	Parameter #9 Selection	0 to 294		Selects the 9th parameter logged into each record.
20	Parameter #10 Selection	0 to 294		Selects the 10th parameter logged into each record.
21	Parameter #11 Selection	0 to 294		Selects the 11th parameter logged into each record.
22	Parameter #12 Selection	0 to 294		Selects the 12th parameter logged into each record.
23	Parameter #13 Selection	0 to 294		Selects the 13th parameter logged into each record.
24	Parameter #14 Selection	0 to 294		Selects the 14th parameter logged into each record.
25	Parameter #15 Selection	0 to 294		Selects the 15th parameter logged into each record.
26	Parameter #16 Selection	0 to 294		Selects the 16th parameter logged into each record.

Table B.22 Trend Log Data (Large Read) (BT# 48)

R I/O Word #	Element Name	Range	Default Value	Comment
1 2	Trend Log Record Number Being Returned	1 to 45,867 ⁽¹⁾	1	Indicates the trend log record number being returned in this table. Record #1 is the oldest record and the largest record number is the most recent record.
3 4	Internal Identifier	0 to 15	-	Each record is stored with a number that counts from 0 up to 15 and then starts over. This is used to make sure that multiple reads of this table contain a continuous sequence of records.
4 5	Timestamp; Year	1998 to 2097	-	The year when the record was logged.
7 8	Month/Date	0101 to 1231	-	The month and day when the record was logged. Number/100 = Month, remainder = Date (Ex: 215 = February 15)
9 10	Hour/Minute	0000 to 2359	-	The hour and minute when the record was logged. Number/100 = Hour, remainder = Minutes (Ex: 1331 = 1:31 pm)
11 12	Seconds/Hundreths	0000 to 5999	-	Seconds and hundredths of seconds when the record was logged. Number/100 = Seconds, remainder = hSec (Ex: 5999 = 59.99 seconds)
13 14	User Selected Element #1	-	-	The value of the parameter which was previously configured as parameter #1 during a write to Table B.21.
15 16	User Selected Element #2	-	-	The value of the parameter which was previously configured as parameter #2 during a write to Table B.21.
17 18	User Selected Element #3	-	-	The value of the parameter which was previously configured as parameter #3 during a write to Table B.21.
19 20	User Selected Element #4	-	-	The value of the parameter which was previously configured as parameter #4 during a write to Table B.21.
21 22	User Selected Element #5	-	-	The value of the parameter which was previously configured as parameter #5 during a write to Table B.21.
23 24	User Selected Element #6	-	-	The value of the parameter which was previously configured as parameter #6 during a write to Table B.21.
25 26	User Selected Element #7	-	-	The value of the parameter which was previously configured as parameter #7 during a write to Table B.21.
27 28	User Selected Element #8	-	-	The value of the parameter which was previously configured as parameter #8 during a write to Table B.21.
29 30	User Selected Element #9	-	-	The value of the parameter which was previously configured as parameter #9 during a write to Table B.21.
31 32	User Selected Element #10	-	-	The value of the parameter which was previously configured as parameter #10 during a write to Table B.21.
33 34	User Selected Element #11	-	-	The value of the parameter which was previously configured as parameter #11 during a write to Table B.21.
35 36	User Selected Element #12	-	-	The value of the parameter which was previously configured as parameter #12 during a write to Table B.21.
37 38	User Selected Element #13	-	-	The value of the parameter which was previously configured as parameter #13 during a write to Table B.21.
39 40	User Selected Element #14	-	-	The value of the parameter which was previously configured as parameter #14 during a write to Table B.21.
41 42	User Selected Element #15	-	-	The value of the parameter which was previously configured as parameter #15 during a write to Table B.21.
43 44	User Selected Element #16	-	-	The value of the parameter which was previously configured as parameter #16 during a write to Table B.21.

⁽¹⁾ The maximum record number depends on the number of parameters per record, the number of records currently in the trend log and if the log is configured in "fill and stop" or "overwrite" mode.

Table B.23 Min/Max Log Configuration/Readback Element Select (BT# 13)

R I/O Word #	Element Name	Range	Default Value	Comment
1	Password	0 to 9999	-	Correct password is required to enable/disable or clear min/max log, but not required to select a min/max record to be read back. If you are only selecting a min/max record to be read, set password to -1.
2	Min/Max Element Record to Read	1 to 53	1	On a write, this selects which min/max parameter information is returned during a subsequent read of Table B.25 "Min/Max Log Results (BT# 28)". Refer to TABLE 25 for a list of min/max parameters. On a read, this indicates the value written here during the last write.
3	Readback Mode	0 to 1	0	Selects the readback mode for Table B.25. 0 = Automatically increments to the next parameter record after a read of Table B.25. 1 = Points to same record after a read of Table B.25.
4	Enable/Disable Min/Max Log	0 to 1	1	0 = Disable min/max log. 1 = Enable min/max log.
5	Clear Min/Max Log	0 to 1	0	Write a 1 here to clear the min/max log, otherwise write a 0.
6	Timestamp of Last Min/Max Clear; Year	1998 to 2097	-	Indicates the last time the min/max log was cleared. Value = year
7	Timestamp of Last Min/Max Clear; Month/Day	0101 to 1231	-	Value/100 = Month, remainder = Day (Example: 1230 = December 30)
8	Timestamp of Last Min/Max Clear; Hour/Minute	0000 to 2359	-	Value/100 = Hour, remainder = minute (Example: 1108 = 11:08am)
9	Timestamp of Last Min/Max Clear; Second/Hsec	0000 to 5999	-	Value/100 = seconds, remainder = hundredths of seconds (Example: 5947 = 59.47 seconds)

Table B.24 Min/Max Log Parameter List

Element #	Element Name	Comment
1	L1 Current	See Table B.10, "Metering Voltage, Current and Frequency Results (BT# 38)," on page B-7
2	L2 Current	See Table B.10, "Metering Voltage, Current and Frequency Results (BT# 38)," on page B-7
3	L3 Current	See Table B.10, "Metering Voltage, Current and Frequency Results (BT# 38)," on page B-7
4	Average Current	See Table B.10, "Metering Voltage, Current and Frequency Results (BT# 38)," on page B-7
5	L1-N Voltage	See Table B.10, "Metering Voltage, Current and Frequency Results (BT# 38)," on page B-7
6	L2-N Voltage	See Table B.10, "Metering Voltage, Current and Frequency Results (BT# 38)," on page B-7
7	L3-N Voltage	See Table B.10, "Metering Voltage, Current and Frequency Results (BT# 38)," on page B-7
8	Average L-N Voltage	See Table B.10, "Metering Voltage, Current and Frequency Results (BT# 38)," on page B-7
9	L1-L2 Voltage	See Table B.10, "Metering Voltage, Current and Frequency Results (BT# 38)," on page B-7
10	L2-L3 Voltage	See Table B.10, "Metering Voltage, Current and Frequency Results (BT# 38)," on page B-7
11	L3-L1 Voltage	See Table B.10, "Metering Voltage, Current and Frequency Results (BT# 38)," on page B-7
12	Average L-L Voltage	See Table B.10, "Metering Voltage, Current and Frequency Results (BT# 38)," on page B-7
13	Frequency, Last Cycle	See Table B.10, "Metering Voltage, Current and Frequency Results (BT# 38)," on page B-7
14	L4 Current	See Table B.11, "Metering Sequence Voltage and Current Results (BT# 27)," on page B-8
15	Positive Sequence Current	See Table B.11, "Metering Sequence Voltage and Current Results (BT# 27)," on page B-8
16	Negative Sequence Current	See Table B.11, "Metering Sequence Voltage and Current Results (BT# 27)," on page B-8
17	Percent Current Unbalance	See Table B.11, "Metering Sequence Voltage and Current Results (BT# 27)," on page B-8
18	Positive Sequence Voltage	See Table B.11, "Metering Sequence Voltage and Current Results (BT# 27)," on page B-8
19	Negative Sequence Voltage	See Table B.11, "Metering Sequence Voltage and Current Results (BT# 27)," on page B-8
20	Percent Voltage Unbalance	See Table B.11, "Metering Sequence Voltage and Current Results (BT# 27)," on page B-8
21	Average Frequency	See Table B.11, "Metering Sequence Voltage and Current Results (BT# 27)," on page B-8
22	L1 Real Power	See Table B.12, "Metering Power Results (BT# 31)," on page B-9
23	L2 Real Power	See Table B.12, "Metering Power Results (BT# 31)," on page B-9
24	L3 Real Power	See Table B.12, "Metering Power Results (BT# 31)," on page B-9

Table B.24 Min/Max Log Parameter List

Element #	Element Name	Comment
25	Total Real Power	See Table B.12, "Metering Power Results (BT# 31)," on page B-9
26	L1 Reactive Power	See Table B.12, "Metering Power Results (BT# 31)," on page B-9
27	L2 Reactive Power	See Table B.12, "Metering Power Results (BT# 31)," on page B-9
28	L3 Reactive Power	See Table B.12, "Metering Power Results (BT# 31)," on page B-9
29	Total Reactive Power	See Table B.12, "Metering Power Results (BT# 31)," on page B-9
30	L1 Apparent Power	See Table B.12, "Metering Power Results (BT# 31)," on page B-9
31	L2 Apparent Power	See Table B.12, "Metering Power Results (BT# 31)," on page B-9
32	L3 Apparent Power	See Table B.12, "Metering Power Results (BT# 31)," on page B-9
33	Total Apparent Power	See Table B.12, "Metering Power Results (BT# 31)," on page B-9
34	L1 True Power Factor	See Table B.14, "Metering Power Factor Results (BT# 33)," on page B-10
35	L2 True Power Factor	See Table B.14, "Metering Power Factor Results (BT# 33)," on page B-10
36	L3 True Power Factor	See Table B.14, "Metering Power Factor Results (BT# 33)," on page B-10
37	3-Phase True Power Factor	See Table B.14, "Metering Power Factor Results (BT# 33)," on page B-10
38	L1 Displacement Power Factor	See Table B.14, "Metering Power Factor Results (BT# 33)," on page B-10
39	L2 Displacement Power Factor	See Table B.14, "Metering Power Factor Results (BT# 33)," on page B-10
40	L3 Displacement Power Factor	See Table B.14, "Metering Power Factor Results (BT# 33)," on page B-10
41	3-Phase Displacement Power Factor	See Table B.14, "Metering Power Factor Results (BT# 33)," on page B-10
42	L1 Distortion Power Factor	See Table B.14, "Metering Power Factor Results (BT# 33)," on page B-10
43	L2 Distortion Power Factor	See Table B.14, "Metering Power Factor Results (BT# 33)," on page B-10
44	L3 Distortion Power Factor	See Table B.14, "Metering Power Factor Results (BT# 33)," on page B-10
45	3-Phase Distortion Power Factor	See Table B.14, "Metering Power Factor Results (BT# 33)," on page B-10
46	Demand Current	See Table B.15, "Metering Real and Apparent Energy Results (BT# 29)," on page B-11
47	Demand Power	See Table B.15, "Metering Real and Apparent Energy Results (BT# 29)," on page B-11
48	Demand Reactive Power	See Table B.15, "Metering Real and Apparent Energy Results (BT# 29)," on page B-11
49	Demand Apparent Power	See Table B.15, "Metering Real and Apparent Energy Results (BT# 29)," on page B-11
50	Projected Demand I	See Table B.15, "Metering Real and Apparent Energy Results (BT# 29)," on page B-11
51	Projected Demand W	See Table B.15, "Metering Real and Apparent Energy Results (BT# 29)," on page B-11
52	Projected Demand VAR	See Table B.15, "Metering Real and Apparent Energy Results (BT# 29)," on page B-11
53	Projected Demand VA	See Table B.15, "Metering Real and Apparent Energy Results (BT# 29)," on page B-11

Table B.25 Min/Max Log Results (BT# 28)

R I/O Word #	Element Name	Range	Default Value	Comment
1 2	Parameter Being Returned	1 to 53	-	Indicates the min/max parameter number returned in this table. See Table B.24 on page B-19 for a list of min/max parameters.
3 4	MIN Value for Element	-999.9x10 ² ₁ to 999.9x10 ²¹	-	The minimum value recorded for the parameter since the last clear of the min/max log.
5 6	MAX Value for Element	-999.9x10 ² ₁ to 999.9x10 ²¹	-	The maximum value recorded for the parameter since the last clear of the main/max log.
7 8	Timestamp When MIN Occurred: Year	1998 to 2097	-	Indicates when the minimum value was recorded for the parameter. Value = year
9 10	Timestamp When MIN Occurred: Month/Day	0101 to 1231	-	Indicates when the minimum value was recorded for the parameter. Value/100 = Month, remainder = Day (Example: 1230 = December 30)

Table B.25 Min/Max Log Results (BT# 28)

R I/O Word #	Element Name	Range	Default Value	Comment
11 12	Timestamp When MIN Occurred: Hour/Minute	0000 to 2359	-	Indicates when the minimum value was recorded for the parameter. Value/100 = Hour, remainder = Minute (Example: 1108 = 11:08am)
13 14	Timestamp When MIN Occurred: Second/Hundredths of Seconds	0000 to 5999	-	Indicates when the minimum value was recorded for the parameter. Value/100 = seconds, remainder = hundredths of seconds (Example: 5947 = 59.47 seconds)
15 16	Timestamp When MAX Occurred: Year	1998 to 2097	-	Indicates when the maximum value was recorded for the parameter. Value = year
17 18	Timestamp When MAX Occurred: Month/Day	0101 to 1231	-	Indicates when the maximum value was recorded for the parameter. Value/100 = Month, remainder = Day
19 20	Timestamp When MAX Occurred: Hour/Minute	0000 to 2359	-	Indicates when the maximum value was recorded for the parameter. Value/100 = Hour, remainder = Minute
21 22	Timestamp When MAX Occurred: Second/Hundredths of Seconds	0000 to 5999	-	Indicates when the maximum value was recorded for the parameter. Value/100 = seconds, remainder = hundredths of seconds

Table B.26 Event Log Configuration/Readback Record Select (BT# 9)

R I/O Word #	Element Name	Range	Default Value	Comment
1	Password	0 to 9999	-	The correct password is required to configure the event log, but is not required to select an event log record to be read back. If you are only selecting an event log record to be read, set password to -1.
2	Event Log Record to be Read	1 to 50	-	Specifies an event log record to be read. 1 = oldest event 50 = most recent record (if event log is full)
3	Readback Mode	0 to 1	0	Selects the readback mode for Table B.24 "Min/Max Log Parameter List". 0 = Even log record # is incremented after a read of Table B.24. 1 = Same event log record returned on successive reads of Table B.24.
4	Enable/Disable Save of Status Input Changes to Event Log	0 to 1	1	0 = Disable recording of status input changes into the event log. 1 = Enable recording of status input changes into the event log.
5	Number of Events in the Event Log	1 to 50	-	Returns the number of events currently in the event log. If the event log is full, this value returns 50.

Table B.27 Event Log Results (BT# 21)

R I/O Word #	Element Name	Range	Default Value	Comment
1	Record Number being Returned	1 to 50	-	Indicates the number of the event log record returned in this table.
2	Internal Identifier	0 to 32768	-	An incremental number assigned to each new event record in the event log. This can be used to make sure that multiple reads of this table contain a continuous sequence of records.
3	Timestamp of Event: Year	1998 to 2097	-	Indicates the time when the event was logged. Value = year
4	Timestamp of event: Month/Day	0101 to 1231	-	Indicates the time when the event was logged. Value/100 = Month, remainder = Day (Example: 1230 = December 30)
5	Timestamp of event: Hour/Minute	0000 to 2359	-	Indicates the time when the event was logged. Value/100 = Hour, remainder = Minute (Example: 1108 = 11:08am)
6	Timestamp of event: Second/ Hundredths of Seconds	0000 to 5999	-	Indicates the time when the event was logged. Value/100 = seconds, remainder = hundredths of seconds (Example: 5947 = 59.47 seconds)
7	Event Type	1 to 15	-	Indicates the type of event that has occurred. SEE TABLE OF EVENT LIST TYPES
8	Event Code	-	-	Indicates additional information about the event that has occurred. If the event was a setpoint, this indicates the setpoint number.

Table B.27 Event Log Results (BT# 21)

R I/O Word #	Element Name	Range	Default Value	Comment
9	Setpoint Type	0 to 44	-	Indicates additional information about the event that has occurred. If the event was a setpoint, this indicates the type of setpoint that triggered the event.
10	Setpoint Evaluation Condition	0 to 5	-	Indicates additional information about the event that has occurred. If the event was a setpoint, this indicates the "evaluation condition" that was part of the setpoint configuration. See Table B.18 on page B-14.
11	Setpoint Level - Integer	0 to 9999	-	Indicates additional information about the event that has occurred. If the event was a setpoint, this indicates the setpoint limit that was crossed to cause the setpoint to trigger. Setpoint limit = integer x 10 ^{exponent} (Example: if integer = 1440 and exponent = 1, limit value = 14,400)
12	Setpoint Level - Exponent	0 to 21	-	
13	Setpoint Action/Release Delay	0 to 3600	-	Indicates additional information about the event that has occurred. If the event was a setpoint, and the setpoint was asserted, this indicates the previously configured assert delay (if the setpoint was released, this indicates the previously configured release delay).
14	Setpoint Action	0 to 32	-	Indicates additional information about the event that has occurred. If the event was a setpoint, this indicates the type of output action that was performed.

Table B.28 List of Event Types

Element #	Element Name	Comment
1	No Event	Effectively disables the setpoint.
2	Setpoint Triggered	A setpoint has been triggered.
3	Setpoint Released	A previously triggered setpoint is now released.
4	Relay Force Energized	The relay was forced energized via the display module or a communication port.
5	Relay Force De-energized	The relay was force de-energized via the display module or a communication port.
6	Relay Force Released	The relay force was released via the display module or communication port.
7	Status Input Set	One of the status inputs detected an external closed contact.
8	Status Input Cleared	One of the status inputs detected an opening of external contacts.
9	Command Received	A command was issued via the display module or communication port (clear log, force relay, etc).
10	Power-up/Reset	The device was restarted.
11	Power-Down	The device lost external control power or was reset internally.
12	Selftest Failure	An internal condition was detected that required shut-down of most powermonitor functions.
13	Date/Time Set	The date and/or time was altered via the display module or communications port.
14	Change of Non-Setpoint Configuration Data	Some configuration data other than setpoint configuration data was altered via the display module or communication port.
15	Change of Setpoint Configuration Data	Setpoint configuration was altered via the display module or communication port.

Table B.29 User Configured Table Setup (BT# 35)

R I/O Word #	Element Name	Range	Default Value	Comment
1	Present Unit Password	0 to 9999	-	The correct password is required to change the contents of a user-configurable table.
2	DF1 File Number to Configure	See Comment	DF1=31	Specifies which configurable table to configure. For DF1, the only valid file selection is 31 (File F31)
3	Reserved	0	0	Reserved. On a write, place a 0 here to ensure compatibility with future firmware revisions.
4	Selection for Element #1	0 to 294	71 (L1-L2 V)	On a write, this specifies the parameter that is returned as parameter #1 in subsequent reads from the user-configurable table.
5	Selection for Element #2	0 to 294	72 (L2-L3 V)	On a write, this specifies the parameter that is returned as parameter #2 in subsequent reads from the user-configurable table.
6	Selection for Element #3	0 to 294	73 (L3-L1 V)	Save as above, except for parameter #3.
7	Selection for Element #4	0 to 294	63 (I1)	Save as above, except for parameter #4.
8	Selection for Element #5	0 to 294	64 (I2)	Save as above, except for parameter #5.
9	Selection for Element #6	0 to 294	65 (I3)	Save as above, except for parameter #6.
10	Selection for Element #7	0 to 294	90 (w)	Save as above, except for parameter #7.
11	Selection for Element #8	0 to 294	98 (VA)	Save as above, except for parameter #8.
12	Selection for Element #9	0 to 294	94 (VAR)	Save as above, except for parameter #9.
13	Selection for Element #10	0 to 294	111 (PF)	Save as above, except for parameter #10.
14	Selection for Element #11	0 to 294	100 (Dmd W)	Save as above, except for parameter #11.
15	Selection for Element #12	0 to 294	122 (kWh)	Save as above, except for parameter #12.
16	Selection for Element #13	0 to 294	130 (Status)	Save as above, except for parameter #13.
17	Selection for Element #14	0 to 294	14 (Year)	Save as above, except for parameter #14.
18	Selection for Element #15	0 to 294	21 (Mo/Dy)	Save as above, except for parameter #15.
19	Selection for Element #16	0 to 294	22 (Hr/min)	Save as above, except for parameter #16.
20	Selection for Element #17	0 to 294	23 (Sec/hsc)	Save as above, except for parameter #17.
21	Selection for Element #18	0 to 294	0	Save as above, except for parameter #18.
22	Selection for Element #19	0 to 294	0	Save as above, except for parameter #19.
23	Selection for Element #20	0 to 294	0	Save as above, except for parameter #20.
24	Selection for Element #21	0 to 294	0	Save as above, except for parameter #21.
25	Selection for Element #22	0 to 294	0	Save as above, except for parameter #22.
26	Selection for Element #23	0 to 294	0	Save as above, except for parameter #23.

Table B.30 User-Configured Table Results (BT# 6, 32, 62)

R I/O Word #	Element Name	Range	Default Value	Comment
1	User-Defined #1	0 to 294	-	Returns the value of the parameter that was previously setup as Parameter #1 during a write to Table B.29.
2	User-Defined #2	0 to 294	-	Returns the value of the parameter that was previously setup as Parameter #2 during a write to Table B.29.
3	User-Defined #3	0 to 294	-	Returns the value of the parameter that was previously setup as Parameter #3 during a write to Table B.29.
4	User-Defined #4	0 to 294	-	Returns the value of the parameter that was previously setup as Parameter #4 during a write to Table B.29.
5	User-Defined #5	0 to 294	-	Returns the value of the parameter that was previously setup as Parameter #5 during a write to Table B.29.
6	User-Defined #6	0 to 294	-	Returns the value of the parameter that was previously setup as Parameter #6 during a write to Table B.29.
7	User-Defined #7	0 to 294	-	Returns the value of the parameter that was previously setup as Parameter #7 during a write to Table B.29.
8	User-Defined #8	0 to 294	-	Returns the value of the parameter that was previously setup as Parameter #8 during a write to Table B.29.
9	User-Defined #9	0 to 294	-	Returns the value of the parameter that was previously setup as Parameter #9 during a write to Table B.29.
10	User-Defined #10	0 to 294	-	Returns the value of the parameter that was previously setup as Parameter #10 during a write to Table B.29.
.
N	User-Defined #N	0 to 294	-	Returns the value of the parameter that was previously setup as Parameter #N during a write to Table B.29.

Table B.31 Write Error Status (BT# 4)

R I/O Word #	Element Name	Range	Default Value	Comment
1	DF1 File Number	(1)	-	Indicates the DF1 file number that was written to last.
2	Offending Parameter	(2)	-	If most recent write was successful, this returns -1. If the write was unsuccessful, this indicates the first parameter that was not acceptable. If there were no offending parameter values, this returns a 0.

(1) Refer to Table B.1 for a list of tables for various communication protocols that can be written.

(2) Refer to the appropriate write table for a range of parameter numbers.

Table B.32 Harmonic Analysis Configuration/Readback Data Select (BT# 14)

R I/O Word #	Element Name	Range	Default Value	Comment
1	Password	0 to 9999	-	The correct password or -1 can be used to select harmonic channel data to be read back during subsequent reads from Table B.33.
2	Channel	1 to 7	1	On a write, this specifies the channel associated with the data returned in a subsequent read of Table B.33.
3	Readback Mode	0 to 1	0	Selects the readback mode for Table B.33 "Harmonic Results; THD, Crest Factor, and more (BT# 23)". 0 = Channel number is incremented after each read of Table B.33 1 = Same channel data returned on successive reads of Table B.33.
4	Reserved	0	0	Reserved for future use.
5	Reserved	0	0	
6	Reserved	0	0	
7	Reserved	0	0	
8	Reserved	0	0	
9	Reserved	0	0	

Table B.33 Harmonic Results; THD, Crest Factor, and more (BT# 23)

R I/O Word #	Element Name	Range	Default Value	Comment
1 2	Channel Number Returned	1 to 7	-	Indicates the channel associated with the data in this table. 1=V1, 2=I1, 3=V2, 4=I2, 5=V3, 6=I3, 7=I4
3 4	Percent IEEE THD	0.0 to 1000.0	-	Total harmonic distortion based on the IEEE definition. An indications of harmonic content relative to the fundamental.
5 6	Percent IEC THD (DIN)	0.0 to 1000.0	-	Total harmonic distortion (Distortion Index) based on IEC/DIN definition. An indication of the harmonic content relative to the fundamental.
7 8	Crest Factor	0.0 to 10.0	-	The ratio of the peak to the RMS for this channel. An indication of the amount of harmonic distortion present in a waveform.
9 10	THD and Crest Iteration	0 to 32767	-	Increments by 1 for each new iteration of THD and Crest Factor results. Counts from 0 to 32767, then rolls over to 0. Can be used by an external device to determine if the current read of THD and Crest Factor results in this table contains newer data than the previous read of the same results from this table.
11 12	Reserved	0	-	Reserved for future use. A read returns 0.
13 14	Reserved	0	-	
15 16	Reserved	0	-	
17 18	Reserved	0	-	

Table B.34 List of Parameters for Trend Log and Configurable Table

Param #	Element Name	Comment
0	None	No parameter. If this is selected, a 0 is returned for that parameter on a read of the user-configurable table.
1	Relay output status	See Table B.4, "Discrete Data (BT# 10)," on page B-3
2	Solid-state KYZ output status	See Table B.4, "Discrete Data (BT# 10)," on page B-3
3	Alarm output word	See Table B.4, "Discrete Data (BT# 10)," on page B-3
4	Status inputs state	See Table B.4, "Discrete Data (BT# 10)," on page B-3
5	Status input #1 counter	See Table B.4, "Discrete Data (BT# 10)," on page B-3
6	Status input #2 counter	See Table B.4, "Discrete Data (BT# 10)," on page B-3
7	Voltage Mode (Wiring Configuration)	See Table B.5, "Basic Device Configuration (BT# 20)," on page B-3
8	PT Primary	See Table B.5, "Basic Device Configuration (BT# 20)," on page B-3
9	PT Secondary	See Table B.5, "Basic Device Configuration (BT# 20)," on page B-3
10	I1/I2/I3 CT Primary	See Table B.5, "Basic Device Configuration (BT# 20)," on page B-3
11	I1/I2/I3 CT Secondary	See Table B.5, "Basic Device Configuration (BT# 20)," on page B-3
12	I4 CT Primary	See Table B.5, "Basic Device Configuration (BT# 20)," on page B-3
13	I4 CT Secondary	See Table B.5, "Basic Device Configuration (BT# 20)," on page B-3
14	Date: Year	See Table B.6, "Date and Time (BT# 12)," on page B-4
15	Date: Month	See Table B.6, "Date and Time (BT# 12)," on page B-4
16	Date: Day	See Table B.6, "Date and Time (BT# 12)," on page B-4
17	Time: Hour	See Table B.6, "Date and Time (BT# 12)," on page B-4
18	Time: Minute	See Table B.6, "Date and Time (BT# 12)," on page B-4
19	Time: Seconds	See Table B.6, "Date and Time (BT# 12)," on page B-4
20	Time: Hundredths of seconds	See Table B.6, "Date and Time (BT# 12)," on page B-4
21	Date: Month/day	See Table B.6, "Date and Time (BT# 12)," on page B-4
22	Time: Hour/minute	See Table B.6, "Date and Time (BT# 12)," on page B-4
23	Time Second/hsec	See Table B.6, "Date and Time (BT# 12)," on page B-4
24	Demand Period Length	See Table B.7, "Advanced Device Configuration (BT# 26)," on page B-4
25	Number of Demand Periods	See Table B.7, "Advanced Device Configuration (BT# 26)," on page B-4
26	Predicted Demand Type	See Table B.7, "Advanced Device Configuration (BT# 26)," on page B-4
27	KYZ Pulse Output Parameter	See Table B.7, "Advanced Device Configuration (BT# 26)," on page B-4
28	KYZ Pulse Output Scale	See Table B.7, "Advanced Device Configuration (BT# 26)," on page B-4
29	KYZ Pulse Output Width	See Table B.7, "Advanced Device Configuration (BT# 26)," on page B-4
30	Relay Pulse Output Parameter	See Table B.7, "Advanced Device Configuration (BT# 26)," on page B-4
31	Relay Pulse Output Scale	See Table B.7, "Advanced Device Configuration (BT# 26)," on page B-4
32	Relay Pulse Output Width	See Table B.7, "Advanced Device Configuration (BT# 26)," on page B-4
33	RMS Resolution	See Table B.7, "Advanced Device Configuration (BT# 26)," on page B-4
34	RMS result averaging	See Table B.7, "Advanced Device Configuration (BT# 26)," on page B-4
35	Frequency averaging	See Table B.7, "Advanced Device Configuration (BT# 26)," on page B-4
36	Default relay state in event of comm loss	See Table B.7, "Advanced Device Configuration (BT# 26)," on page B-4
37	Default KYZ state in event of comm loss	See Table B.7, "Advanced Device Configuration (BT# 26)," on page B-4
38	DM text scroll rate	See Table B.7, "Advanced Device Configuration (BT# 26)," on page B-4
39	Protocol	See Table B.8, "RS-485 Communication Configuration (BT# 11)," on page B-6
40	Delay	See Table B.8, "RS-485 Communication Configuration (BT# 11)," on page B-6
41	Baud rate	See Table B.8, "RS-485 Communication Configuration (BT# 11)," on page B-6

Table B.34 List of Parameters for Trend Log and Configurable Table

Param #	Element Name	Comment
42	Device address	See Table B.8, "RS-485 Communication Configuration (BT# 11)," on page B-6
43	Data format	See Table B.8, "RS-485 Communication Configuration (BT# 11)," on page B-6
44	Comm parameter #1	See Table B.9, "Remote I/O Communication Configuration (BT# 24)," on page B-7
45	Comm parameter #2	See Table B.9, "Remote I/O Communication Configuration (BT# 24)," on page B-7
46	Comm parameter #3	See Table B.9, "Remote I/O Communication Configuration (BT# 24)," on page B-7
47	Comm parameter #4	See Table B.9, "Remote I/O Communication Configuration (BT# 24)," on page B-7
48	Comm parameter #5	See Table B.9, "Remote I/O Communication Configuration (BT# 24)," on page B-7
49	Comm parameter #6	See Table B.9, "Remote I/O Communication Configuration (BT# 24)," on page B-7
50	Comm parameter #7	See Table B.9, "Remote I/O Communication Configuration (BT# 24)," on page B-7
51	Comm parameter #8	See Table B.9, "Remote I/O Communication Configuration (BT# 24)," on page B-7
52	Comm parameter #9	See Table B.9, "Remote I/O Communication Configuration (BT# 24)," on page B-7
53	Comm parameter #10	See Table B.9, "Remote I/O Communication Configuration (BT# 24)," on page B-7
54	Comm parameter #11	See Table B.9, "Remote I/O Communication Configuration (BT# 24)," on page B-7
55	Comm parameter #12	See Table B.9, "Remote I/O Communication Configuration (BT# 24)," on page B-7
56	Comm parameter #13	See Table B.9, "Remote I/O Communication Configuration (BT# 24)," on page B-7
57	Comm parameter #14	See Table B.9, "Remote I/O Communication Configuration (BT# 24)," on page B-7
58	Comm parameter #15	See Table B.9, "Remote I/O Communication Configuration (BT# 24)," on page B-7
59	Comm parameter #16	See Table B.9, "Remote I/O Communication Configuration (BT# 24)," on page B-7
60	Comm parameter #17	See Table B.9, "Remote I/O Communication Configuration (BT# 24)," on page B-7
61	Comm parameter #18	See Table B.9, "Remote I/O Communication Configuration (BT# 24)," on page B-7
62	Comm parameter #19	See Table B.9, "Remote I/O Communication Configuration (BT# 24)," on page B-7
63	L1 Current	See Table B.10, "Metering Voltage, Current and Frequency Results (BT# 38)," on page B-7
64	L2 Current	See Table B.10, "Metering Voltage, Current and Frequency Results (BT# 38)," on page B-7
65	L3 Current	See Table B.10, "Metering Voltage, Current and Frequency Results (BT# 38)," on page B-7
66	Avg Current	See Table B.10, "Metering Voltage, Current and Frequency Results (BT# 38)," on page B-7
67	L1-N Voltage	See Table B.10, "Metering Voltage, Current and Frequency Results (BT# 38)," on page B-7
68	L2-N Voltage	See Table B.10, "Metering Voltage, Current and Frequency Results (BT# 38)," on page B-7
69	L3-N Voltage	See Table B.10, "Metering Voltage, Current and Frequency Results (BT# 38)," on page B-7
70	Avg L-N Voltage	See Table B.10, "Metering Voltage, Current and Frequency Results (BT# 38)," on page B-7
71	L1-L2 Voltage	See Table B.10, "Metering Voltage, Current and Frequency Results (BT# 38)," on page B-7
72	L2-L3 Voltage	See Table B.10, "Metering Voltage, Current and Frequency Results (BT# 38)," on page B-7
73	L3-L1 Voltage	See Table B.10, "Metering Voltage, Current and Frequency Results (BT# 38)," on page B-7
74	Avg L-L Voltage	See Table B.10, "Metering Voltage, Current and Frequency Results (BT# 38)," on page B-7
75	Frequency, last cycle	See Table B.10, "Metering Voltage, Current and Frequency Results (BT# 38)," on page B-7
76	Metering iteration	See Table B.10, "Metering Voltage, Current and Frequency Results (BT# 38)," on page B-7
77	L4 Current	See Table B.11, "Metering Sequence Voltage and Current Results (BT# 27)," on page B-8
78	Positive Sequence Current	See Table B.11, "Metering Sequence Voltage and Current Results (BT# 27)," on page B-8
79	Negative Sequence Current	See Table B.11, "Metering Sequence Voltage and Current Results (BT# 27)," on page B-8
80	% Current unbalance	See Table B.11, "Metering Sequence Voltage and Current Results (BT# 27)," on page B-8
81	Positive Sequence Voltage	See Table B.11, "Metering Sequence Voltage and Current Results (BT# 27)," on page B-8
82	Negative Sequence Voltage	See Table B.11, "Metering Sequence Voltage and Current Results (BT# 27)," on page B-8
83	% Voltage unbalance	See Table B.11, "Metering Sequence Voltage and Current Results (BT# 27)," on page B-8
84	Phase rotation	See Table B.11, "Metering Sequence Voltage and Current Results (BT# 27)," on page B-8
85	Average frequency	See Table B.11, "Metering Sequence Voltage and Current Results (BT# 27)," on page B-8

Table B.34 List of Parameters for Trend Log and Configurable Table

Param #	Element Name	Comment
86	Frequency source	See Table B.11, "Metering Sequence Voltage and Current Results (BT# 27)," on page B-8
87	L1 Real Power	See Table B.12, "Metering Power Results (BT# 31)," on page B-9
88	L2 Real Power	See Table B.12, "Metering Power Results (BT# 31)," on page B-9
89	L3 Real Power	See Table B.12, "Metering Power Results (BT# 31)," on page B-9
90	Total Real Power	See Table B.12, "Metering Power Results (BT# 31)," on page B-9
91	L1 Reactive Power	See Table B.12, "Metering Power Results (BT# 31)," on page B-9
92	L2 Reactive Power	See Table B.12, "Metering Power Results (BT# 31)," on page B-9
93	L3 Reactive Power	See Table B.12, "Metering Power Results (BT# 31)," on page B-9
94	Total Reactive Power	See Table B.12, "Metering Power Results (BT# 31)," on page B-9
95	L1 Apparent Power	See Table B.12, "Metering Power Results (BT# 31)," on page B-9
96	L2 Apparent Power	See Table B.12, "Metering Power Results (BT# 31)," on page B-9
97	L3 Apparent Power	See Table B.12, "Metering Power Results (BT# 31)," on page B-9
98	Total Apparent Power	See Table B.12, "Metering Power Results (BT# 31)," on page B-9
99	Demand Current	See Table B.13, "Metering Demand Results (BT# 25)," on page B-10
100	Demand Power	See Table B.13, "Metering Demand Results (BT# 25)," on page B-10
101	Demand Reactive Power	See Table B.13, "Metering Demand Results (BT# 25)," on page B-10
102	Demand Apparent Power	See Table B.13, "Metering Demand Results (BT# 25)," on page B-10
103	Projected Demand I	See Table B.13, "Metering Demand Results (BT# 25)," on page B-10
104	Projected Demand W	See Table B.13, "Metering Demand Results (BT# 25)," on page B-10
105	Projected Demand VAR	See Table B.13, "Metering Demand Results (BT# 25)," on page B-10
106	Projected Demand VA	See Table B.13, "Metering Demand Results (BT# 25)," on page B-10
107	Elapsed demand period time	See Table B.13, "Metering Demand Results (BT# 25)," on page B-10
108	L1 True Power Factor	See Table B.14, "Metering Power Factor Results (BT# 33)," on page B-10
109	L2 True Power Factor	See Table B.14, "Metering Power Factor Results (BT# 33)," on page B-10
110	L3 True Power Factor	See Table B.14, "Metering Power Factor Results (BT# 33)," on page B-10
111	3-phase True PF	See Table B.14, "Metering Power Factor Results (BT# 33)," on page B-10
112	L1 Displacement Power Factor	See Table B.14, "Metering Power Factor Results (BT# 33)," on page B-10
113	L2 Displacement Power Factor	See Table B.14, "Metering Power Factor Results (BT# 33)," on page B-10
114	L3 Displacement Power Factor	See Table B.14, "Metering Power Factor Results (BT# 33)," on page B-10
115	3-phase Displacement PF	See Table B.14, "Metering Power Factor Results (BT# 33)," on page B-10
116	L1 Distortion Power Factor	See Table B.14, "Metering Power Factor Results (BT# 33)," on page B-10
117	L2 Distortion Power Factor	See Table B.14, "Metering Power Factor Results (BT# 33)," on page B-10
118	L3 Distortion Power Factor	See Table B.14, "Metering Power Factor Results (BT# 33)," on page B-10
119	3-phase Distortion PF	See Table B.14, "Metering Power Factor Results (BT# 33)," on page B-10
120	KWh forward	See Table B.15, "Metering Real and Apparent Energy Results (BT# 29)," on page B-11
121	KWh reverse	See Table B.15, "Metering Real and Apparent Energy Results (BT# 29)," on page B-11
122	Kwh net	See Table B.15, "Metering Real and Apparent Energy Results (BT# 29)," on page B-11
123	KVAh	See Table B.15, "Metering Real and Apparent Energy Results (BT# 29)," on page B-11
124	KVARh forward	See Table B.16, "Metering Reactive Energy and Amp-Hour Results (BT# 30)," on page B-12
125	KVARh reverse	See Table B.16, "Metering Reactive Energy and Amp-Hour Results (BT# 30)," on page B-12
126	KVARh net	See Table B.16, "Metering Reactive Energy and Amp-Hour Results (BT# 30)," on page B-12
127	Ah	See Table B.16, "Metering Reactive Energy and Amp-Hour Results (BT# 30)," on page B-12
128	Bulletin number	See Table B.17, "Selftest/Diagnostic Results (BT# 36)," on page B-12
129	Series	See Table B.17, "Selftest/Diagnostic Results (BT# 36)," on page B-12

Table B.34 List of Parameters for Trend Log and Configurable Table

Param #	Element Name	Comment
130	Overall status	See Table B.17, "Selftest/Diagnostic Results (BT# 36)," on page B-12
131	ASIC status	See Table B.17, "Selftest/Diagnostic Results (BT# 36)," on page B-12
132	Data FLASH status	See Table B.17, "Selftest/Diagnostic Results (BT# 36)," on page B-12
133	Real-time clock status	See Table B.17, "Selftest/Diagnostic Results (BT# 36)," on page B-12
134	RTC NVRAM status	See Table B.17, "Selftest/Diagnostic Results (BT# 36)," on page B-12
135	Option comm status	See Table B.17, "Selftest/Diagnostic Results (BT# 36)," on page B-12
136	Display module status	See Table B.17, "Selftest/Diagnostic Results (BT# 36)," on page B-12
137	Watchdog status	See Table B.17, "Selftest/Diagnostic Results (BT# 36)," on page B-12
138	VCO lock status	See Table B.17, "Selftest/Diagnostic Results (BT# 36)," on page B-12
139	Reserved Option slot card status	See Table B.17, "Selftest/Diagnostic Results (BT# 36)," on page B-12
140	Application FRN	See Table B.17, "Selftest/Diagnostic Results (BT# 36)," on page B-12
141	Boot code FRN	See Table B.17, "Selftest/Diagnostic Results (BT# 36)," on page B-12
142	ASIC 'FRN'	See Table B.17, "Selftest/Diagnostic Results (BT# 36)," on page B-12
143	Option comm FRN	See Table B.17, "Selftest/Diagnostic Results (BT# 36)," on page B-12
144	Display module FRN	See Table B.17, "Selftest/Diagnostic Results (BT# 36)," on page B-12
145	Reserved Option slot card FRN	See Table B.17, "Selftest/Diagnostic Results (BT# 36)," on page B-12
146	Digital board revision	See Table B.17, "Selftest/Diagnostic Results (BT# 36)," on page B-12
147	Analog board revision	See Table B.17, "Selftest/Diagnostic Results (BT# 36)," on page B-12
148	Option comm board revision	See Table B.17, "Selftest/Diagnostic Results (BT# 36)," on page B-12
149	Reserved Option slot card revision	See Table B.17, "Selftest/Diagnostic Results (BT# 36)," on page B-12
150	MM Device ID	See Table B.17, "Selftest/Diagnostic Results (BT# 36)," on page B-12
151	MM RAM type	See Table B.17, "Selftest/Diagnostic Results (BT# 36)," on page B-12
152	Display module type	See Table B.17, "Selftest/Diagnostic Results (BT# 36)," on page B-12
153	Option comm type	See Table B.17, "Selftest/Diagnostic Results (BT# 36)," on page B-12
154	Reserved Option slot card type	See Table B.17, "Selftest/Diagnostic Results (BT# 36)," on page B-12
155	Setpoint #1 type	See Table B.18, "Setpoint Setup/Readback Select and Status (BT# 22)," on page B-14
156	Setpoint #2 type	See Table B.18, "Setpoint Setup/Readback Select and Status (BT# 22)," on page B-14
157	Setpoint #3 type	See Table B.18, "Setpoint Setup/Readback Select and Status (BT# 22)," on page B-14
158	Setpoint #4 type	See Table B.18, "Setpoint Setup/Readback Select and Status (BT# 22)," on page B-14
159	Setpoint #5 type	See Table B.18, "Setpoint Setup/Readback Select and Status (BT# 22)," on page B-14
160	Setpoint #6 type	See Table B.18, "Setpoint Setup/Readback Select and Status (BT# 22)," on page B-14
161	Setpoint #7 type	See Table B.18, "Setpoint Setup/Readback Select and Status (BT# 22)," on page B-14
162	Setpoint #8 type	See Table B.18, "Setpoint Setup/Readback Select and Status (BT# 22)," on page B-14
163	Setpoint #9 type	See Table B.18, "Setpoint Setup/Readback Select and Status (BT# 22)," on page B-14
164	Setpoint #10 type	See Table B.18, "Setpoint Setup/Readback Select and Status (BT# 22)," on page B-14
165	Setpoint #1 evaluation condition	See Table B.18, "Setpoint Setup/Readback Select and Status (BT# 22)," on page B-14
166	Setpoint #2 evaluation condition	See Table B.18, "Setpoint Setup/Readback Select and Status (BT# 22)," on page B-14
167	Setpoint #3 evaluation condition	See Table B.18, "Setpoint Setup/Readback Select and Status (BT# 22)," on page B-14
168	Setpoint #4 evaluation condition	See Table B.18, "Setpoint Setup/Readback Select and Status (BT# 22)," on page B-14
169	Setpoint #5 evaluation condition	See Table B.18, "Setpoint Setup/Readback Select and Status (BT# 22)," on page B-14
170	Setpoint #6 evaluation condition	See Table B.18, "Setpoint Setup/Readback Select and Status (BT# 22)," on page B-14
171	Setpoint #7 evaluation condition	See Table B.18, "Setpoint Setup/Readback Select and Status (BT# 22)," on page B-14
172	Setpoint #8 evaluation condition	See Table B.18, "Setpoint Setup/Readback Select and Status (BT# 22)," on page B-14
173	Setpoint #9 evaluation condition	See Table B.18, "Setpoint Setup/Readback Select and Status (BT# 22)," on page B-14

Table B.34 List of Parameters for Trend Log and Configurable Table

Param #	Element Name	Comment
218	Setpoint #4 action type	See Table B.18, "Setpoint Setup/Readback Select and Status (BT# 22)," on page B-14
219	Setpoint #5 action type	See Table B.18, "Setpoint Setup/Readback Select and Status (BT# 22)," on page B-14
220	Setpoint #6 action type	See Table B.18, "Setpoint Setup/Readback Select and Status (BT# 22)," on page B-14
221	Setpoint #7 action type	See Table B.18, "Setpoint Setup/Readback Select and Status (BT# 22)," on page B-14
222	Setpoint #8 action type	See Table B.18, "Setpoint Setup/Readback Select and Status (BT# 22)," on page B-14
223	Setpoint #9 action type	See Table B.18, "Setpoint Setup/Readback Select and Status (BT# 22)," on page B-14
224	Setpoint #10 action type	See Table B.18, "Setpoint Setup/Readback Select and Status (BT# 22)," on page B-14
225	Setpoint #1 status	See Table B.18, "Setpoint Setup/Readback Select and Status (BT# 22)," on page B-14
226	Setpoint #2 status	See Table B.18, "Setpoint Setup/Readback Select and Status (BT# 22)," on page B-14
227	Setpoint #3 status	See Table B.18, "Setpoint Setup/Readback Select and Status (BT# 22)," on page B-14
228	Setpoint #4 status	See Table B.18, "Setpoint Setup/Readback Select and Status (BT# 22)," on page B-14
229	Setpoint #5 status	See Table B.18, "Setpoint Setup/Readback Select and Status (BT# 22)," on page B-14
230	Setpoint #6 status	See Table B.18, "Setpoint Setup/Readback Select and Status (BT# 22)," on page B-14
231	Setpoint #7 status	See Table B.18, "Setpoint Setup/Readback Select and Status (BT# 22)," on page B-14
232	Setpoint #8 status	See Table B.18, "Setpoint Setup/Readback Select and Status (BT# 22)," on page B-14
233	Setpoint #9 status	See Table B.18, "Setpoint Setup/Readback Select and Status (BT# 22)," on page B-14
234	Setpoint #10 status	See Table B.18, "Setpoint Setup/Readback Select and Status (BT# 22)," on page B-14
235	Setpoint #1 accumulated active time	See Table B.18, "Setpoint Setup/Readback Select and Status (BT# 22)," on page B-14
236	Setpoint #2 accumulated active time	See Table B.18, "Setpoint Setup/Readback Select and Status (BT# 22)," on page B-14
237	Setpoint #3 accumulated active time	See Table B.18, "Setpoint Setup/Readback Select and Status (BT# 22)," on page B-14
238	Setpoint #4 accumulated active time	See Table B.18, "Setpoint Setup/Readback Select and Status (BT# 22)," on page B-14
239	Setpoint #5 accumulated active time	See Table B.18, "Setpoint Setup/Readback Select and Status (BT# 22)," on page B-14
240	Setpoint #6 accumulated active time	See Table B.18, "Setpoint Setup/Readback Select and Status (BT# 22)," on page B-14
241	Setpoint #7 accumulated active time	See Table B.18, "Setpoint Setup/Readback Select and Status (BT# 22)," on page B-14
242	Setpoint #8 accumulated active time	See Table B.18, "Setpoint Setup/Readback Select and Status (BT# 22)," on page B-14
243	Setpoint #9 accumulated active time	See Table B.18, "Setpoint Setup/Readback Select and Status (BT# 22)," on page B-14
244	Setpoint #10 accumulated active time	See Table B.18, "Setpoint Setup/Readback Select and Status (BT# 22)," on page B-14
245	Logging interval	See Table B.21, "Trend Log Configuration/Readback Record Select (BT# 34)," on page B-17
246	Logging mode	See Table B.21, "Trend Log Configuration/Readback Record Select (BT# 34)," on page B-17
247	Total records logged	See Table B.21, "Trend Log Configuration/Readback Record Select (BT# 34)," on page B-17
248	Trend log param #1	See Table B.21, "Trend Log Configuration/Readback Record Select (BT# 34)," on page B-17
249	Trend log param #2	See Table B.21, "Trend Log Configuration/Readback Record Select (BT# 34)," on page B-17
250	Trend log param #3	See Table B.21, "Trend Log Configuration/Readback Record Select (BT# 34)," on page B-17
251	Trend log param #4	See Table B.21, "Trend Log Configuration/Readback Record Select (BT# 34)," on page B-17
252	Trend log param #5	See Table B.21, "Trend Log Configuration/Readback Record Select (BT# 34)," on page B-17
253	Trend log param #6	See Table B.21, "Trend Log Configuration/Readback Record Select (BT# 34)," on page B-17
254	Trend log param #7	See Table B.21, "Trend Log Configuration/Readback Record Select (BT# 34)," on page B-17
255	Trend log param #8	See Table B.21, "Trend Log Configuration/Readback Record Select (BT# 34)," on page B-17
256	Trend log param #9	See Table B.21, "Trend Log Configuration/Readback Record Select (BT# 34)," on page B-17
257	Trend log param #10	See Table B.21, "Trend Log Configuration/Readback Record Select (BT# 34)," on page B-17
258	Trend log param #11	See Table B.21, "Trend Log Configuration/Readback Record Select (BT# 34)," on page B-17
259	Trend log param #12	See Table B.21, "Trend Log Configuration/Readback Record Select (BT# 34)," on page B-17
260	Trend log param #13	See Table B.21, "Trend Log Configuration/Readback Record Select (BT# 34)," on page B-17
261	Trend log param #14	See Table B.21, "Trend Log Configuration/Readback Record Select (BT# 34)," on page B-17

Table B.34 List of Parameters for Trend Log and Configurable Table

Param #	Element Name	Comment
262	Trend log param #15	See Table B.21, "Trend Log Configuration/Readback Record Select (BT# 34)," on page B-17
263	Trend log param #16	See Table B.21, "Trend Log Configuration/Readback Record Select (BT# 34)," on page B-17
264	Enable/disable Min/max log	See Table B.23, "Min/Max Log Configuration/Readback Element Select (BT# 13)," on page B-19
265	Timestamp of last min/max clear; year	See Table B.23, "Min/Max Log Configuration/Readback Element Select (BT# 13)," on page B-19
266	Timestamp of last min/max clear; Month/day	See Table B.23, "Min/Max Log Configuration/Readback Element Select (BT# 13)," on page B-19
267	Timestamp of last min/max clear; Hour/min	See Table B.23, "Min/Max Log Configuration/Readback Element Select (BT# 13)," on page B-19
268	Timestamp of last min/max clear; Second/hsec	See Table B.23, "Min/Max Log Configuration/Readback Element Select (BT# 13)," on page B-19
269	Enable/disable save status input changes to Event log	See Table B.26, "Event Log Configuration/Readback Record Select (BT# 9)," on page B-21
270	Number of events in the event log	See Table B.26, "Event Log Configuration/Readback Record Select (BT# 9)," on page B-21
271	Write error status File/BT/Instance number	See Table B.31, "Write Error Status (BT# 4)," on page B-24
272	Write error status Parameter number	See Table B.31, "Write Error Status (BT# 4)," on page B-24
273	V1 % IEEE THD	See Table B.33, "Harmonic Results; THD, Crest Factor, and more (BT# 23)," on page B-25
274	I1 % IEEE THD	See Table B.33, "Harmonic Results; THD, Crest Factor, and more (BT# 23)," on page B-25
275	V2 % IEEE THD	See Table B.33, "Harmonic Results; THD, Crest Factor, and more (BT# 23)," on page B-25
276	I2 % IEEE THD	See Table B.33, "Harmonic Results; THD, Crest Factor, and more (BT# 23)," on page B-25
277	V3 % IEEE THD	See Table B.33, "Harmonic Results; THD, Crest Factor, and more (BT# 23)," on page B-25
278	I3 % IEEE THD	See Table B.33, "Harmonic Results; THD, Crest Factor, and more (BT# 23)," on page B-25
279	I4 % IEEE THD	See Table B.33, "Harmonic Results; THD, Crest Factor, and more (BT# 23)," on page B-25
280	V1 % IEC THD (DIN)	See Table B.33, "Harmonic Results; THD, Crest Factor, and more (BT# 23)," on page B-25
281	I1 % IEC thd (DIN)	See Table B.33, "Harmonic Results; THD, Crest Factor, and more (BT# 23)," on page B-25
282	V2% IEC thd (DIN)	See Table B.33, "Harmonic Results; THD, Crest Factor, and more (BT# 23)," on page B-25
283	I2 % IEC thd (DIN)	See Table B.33, "Harmonic Results; THD, Crest Factor, and more (BT# 23)," on page B-25
284	V3 % IEC thd (DIN)	See Table B.33, "Harmonic Results; THD, Crest Factor, and more (BT# 23)," on page B-25
285	I3 % IEC thd (DIN)	See Table B.33, "Harmonic Results; THD, Crest Factor, and more (BT# 23)," on page B-25
286	I4 % IEC thd (DIN)	See Table B.33, "Harmonic Results; THD, Crest Factor, and more (BT# 23)," on page B-25
287	V1 Crest Factor	See Table B.33, "Harmonic Results; THD, Crest Factor, and more (BT# 23)," on page B-25
288	I1 Crest Factor	See Table B.33, "Harmonic Results; THD, Crest Factor, and more (BT# 23)," on page B-25
289	V2 Crest Factor	See Table B.33, "Harmonic Results; THD, Crest Factor, and more (BT# 23)," on page B-25
290	I2 Crest Factor	See Table B.33, "Harmonic Results; THD, Crest Factor, and more (BT# 23)," on page B-25
291	V3 Crest Factor	See Table B.33, "Harmonic Results; THD, Crest Factor, and more (BT# 23)," on page B-25
292	I3 Crest Factor	See Table B.33, "Harmonic Results; THD, Crest Factor, and more (BT# 23)," on page B-25
293	I4 Crest Factor	See Table B.33, "Harmonic Results; THD, Crest Factor, and more (BT# 23)," on page B-25
294	THD & Crest iteration	See Table B.33, "Harmonic Results; THD, Crest Factor, and more (BT# 23)," on page B-25

Remote I/O Communications Ladder Diagrams

Ladder Program Description

This appendix contains a sample ladder program that interfaces to the Powermonitor 3000.

PLC-5 R I/O Operation

During initialization of Run mode, the sequencer input file is loaded with the numbers corresponding to the block transfers to be performed. Once Run mode has begun, the ladder program remains in this mode.

NOTE

The speed at which the processor performs the messages may be altered by resetting the On-Delay timer that is located within the sequencer output rung. However the availability of new data values is controlled by the Powermonitor 3000 table update rate.

PLC-5 R I/O Data Files Used

Data File Address	Block Transfer Size	Description
N9	1	N9:0 Sequencer Output
N10	Variable	N10:0 Sequencer Input
R6:0		Sequencer Control
Message Read Data Table Locations		
(Control/Data)		
N20 / F30	38	Voltage/Current Data
N21 / F31	31	Real-Time Power
N22 / F32	33	Power Factor
N23 / N33	29	KWh and KVAh
N24 / N34	30	KVarh
N25 / F35	25	Demand
N26 / N36	36	Diagnostic

The reset word for the sequencer is N10:0. The first word in the rotation of the sequencer is N10:1. The value in N10:0 must be the same as that in N10:1. The size of file N10 is equal to the size of the largest sequencer input file. This size depends on the number of block transfers to be performed. The sequencer length may be expanded or reduced for run mode. It is imperative that the corresponding file that serves as the source of the sequencer's input file, N10, must be modified accordingly.

IMPORTANT Failure to modify the length of file N10 for a modification of either the Configuration or Run sequence results in improper operation of the ladder program, and possible FAULT of the processor due to invalid indirect offsets.

File Data Values

Prior to running the sample ladder, the sequencer initialization file needs to be loaded with the numbers that correspond to the block transfer sequence. The following is a list of each mode's initialization file and the required/possible numbers to be stored in each. The first value of a block transfer sequence must be duplicated in both position 0 and 1 of an initialization file.

N10 - Run Mode

Required numbers are 20, 20, 21, 22, 23, 24, 25, and 26.

Sample Ladder Listing

This example ladder program shows a way to configure the block transfer for the Powermonitor 3000.

ATTENTION



Proper operation of the ladder program is the responsibility of the user. No warranty is expressed or implied by using these ladder configurations.

This ladder is subject to change.

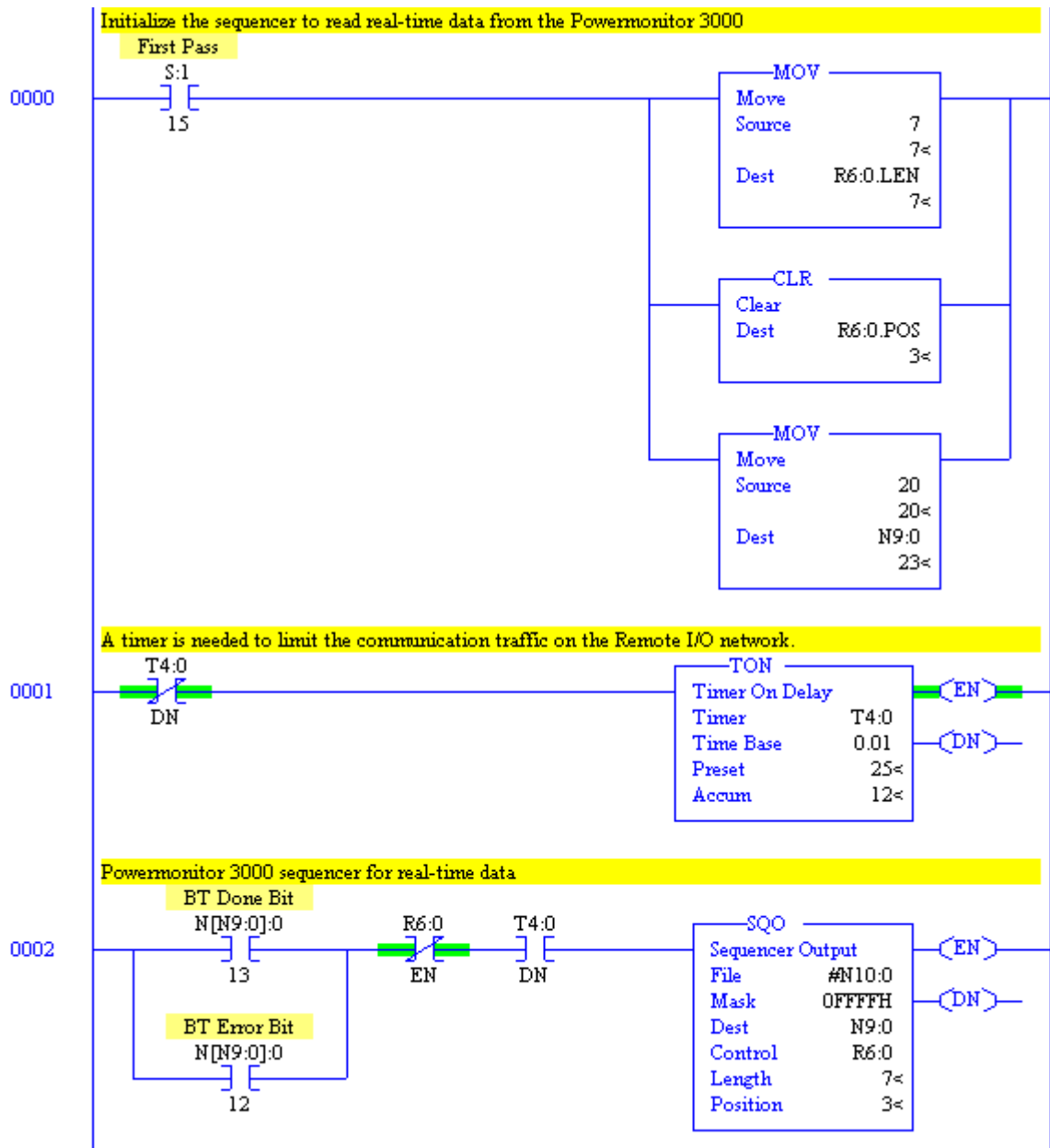

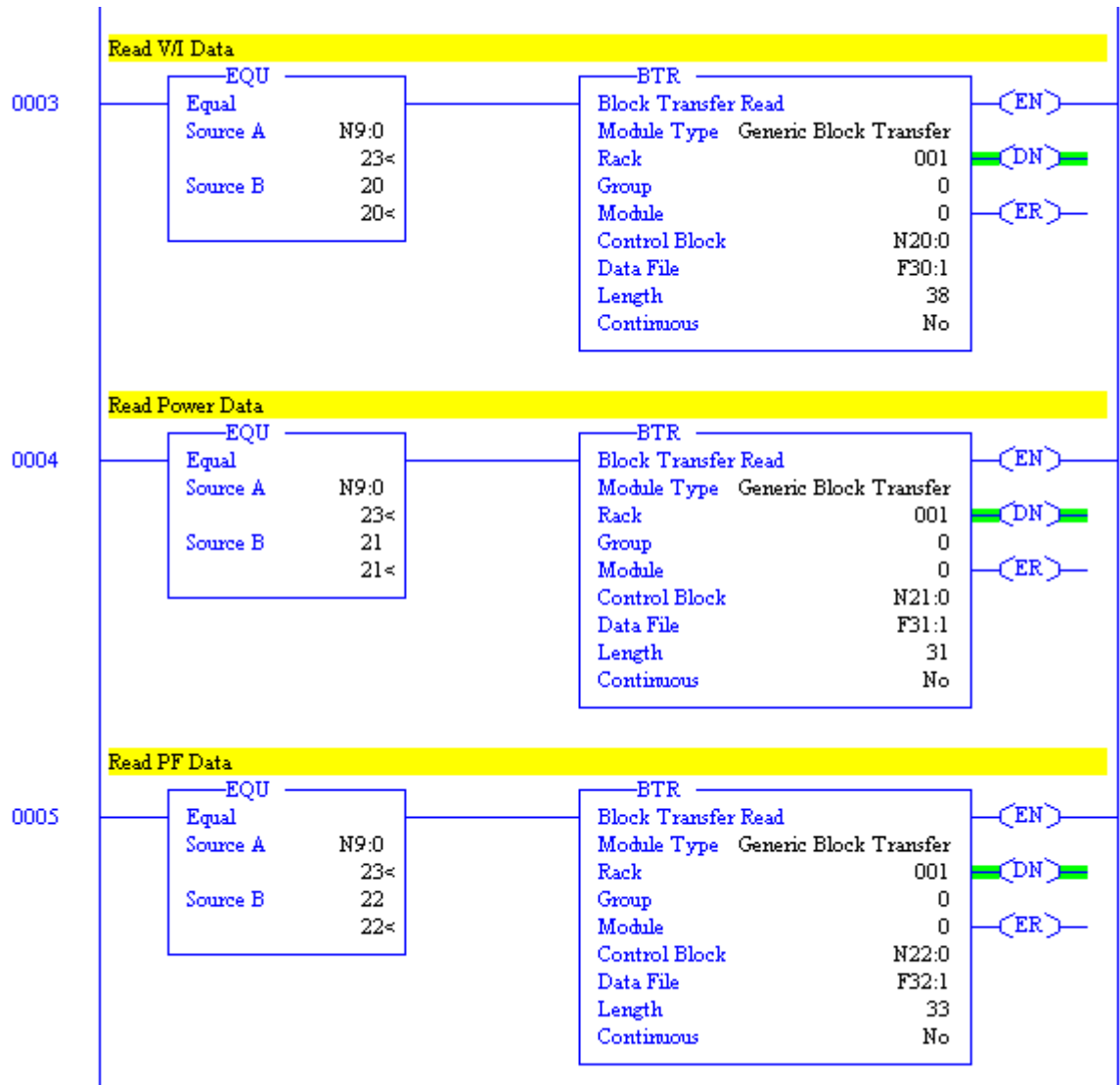

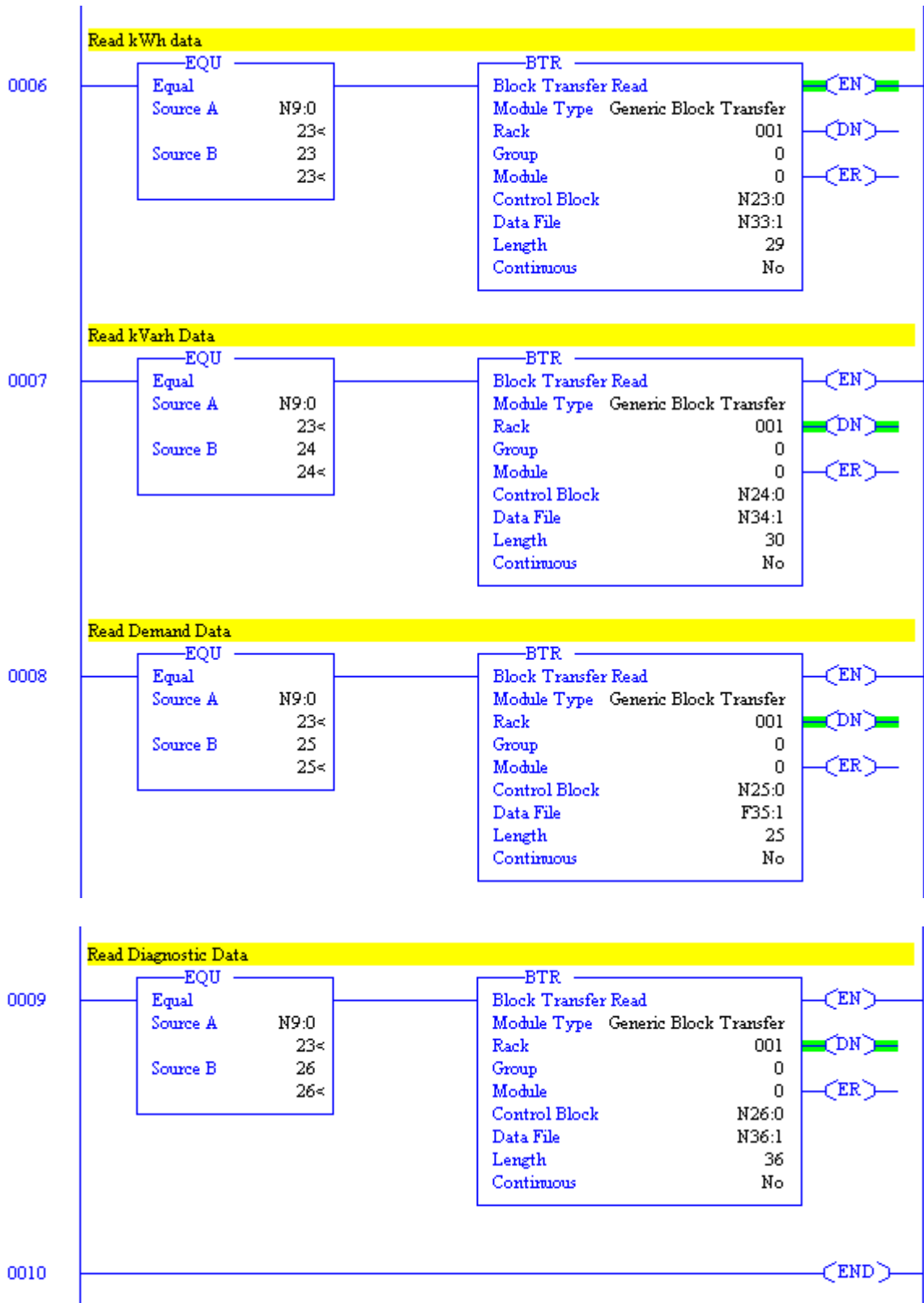

C

catalog number explanation *A-1*
chapter objectives *1*
configuration items *6*
 communication *6*

D

data tables *B-1*

E

electrostatic discharge *3*

F

field service considerations *5*
file data values *C-2*

G

general operation *5*

communication card set-up *5*
led indicators *5*

I

introduction *1*

L

ladder diagrams *C-1*
ladder program description *C-1*

M

mounting *2*
 master module *2*

P

performance features *1*
product description *1*

W

wiring *3*



Reach us now at www.rockwellautomation.com

Wherever you need us, Rockwell Automation brings together leading brands in industrial automation including Allen-Bradley controls, Reliance Electric power transmission products, Dodge mechanical power transmission components, and Rockwell Software. Rockwell Automation's unique, flexible approach to helping customers achieve a competitive advantage is supported by thousands of authorized partners, distributors and system integrators around the world.



Americas Headquarters, 1201 South Second Street, Milwaukee, WI 53204, USA, Tel: (1) 414 382-2000, Fax: (1) 414 382-4444

European Headquarters SA/NV, avenue Herrmann Debroux, 46, 1160 Brussels, Belgium, Tel: (32) 2 663 06 00, Fax: (32) 2 663 06 40

Asia Pacific Headquarters, 27/F Citicorp Centre, 18 Whitfield Road, Causeway Bay, Hong Kong, Tel: (852) 2887 4788, Fax: (852) 2508 1846

Publication 1404-IN004A-US-P - November 1999

**Rockwell
Automation**

PN 40055-205-01(A)

© (1999) Rockwell International Corporation. Printed in the U.S.A.