

Allen-Bradley Bulletin 150 SMC Dialog Plus™ Controller—Getting Started

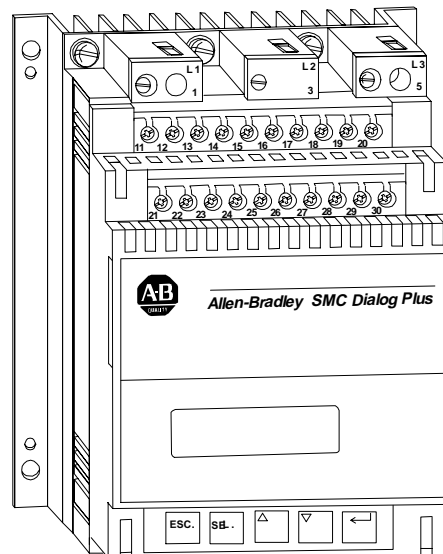

Introduction

This guide provides you with the basic information required to start up your SMC Dialog Plus™ controller. Factory default settings and information regarding installing, programming, and calibrating the controller are described here. For detailed information on specific product features or configurations, refer to the *SMC Dialog Plus User Manual*, Publication 150-5.3.

This guide is intended for qualified service personnel responsible for setting up and servicing these devices. You must have previous experience with and a basic understanding of electrical terminology, configuration procedures, required equipment, and safety precautions.

SMC Dialog Plus is a trademark of Rockwell Automation.

Installation

The open-style design of the SMC Dialog Plus controller requires that it be installed in an enclosure. **The internal temperature of the enclosure must be kept within 0...5 °C (32...122 °F).**

The controller is convection cooled. It is important to mount the controller in a position that allows air to flow vertically through the power structure. Allow for a minimum of six inches (15 cm) of free space around all sides of the controller.

Wiring

Power Wiring

Refer to the product nameplate for power lug termination information including:

- Lug wire capacity
- Tightening torque requirements
- Lug kit catalog numbers (97...1000 A)

Control Wiring

Refer to the product nameplate for control terminal wire capacity and tightening torque requirements. Each control terminal will accept a maximum of two wires.

The SMC Dialog Plus controller accepts control power input of either 100...240V AC, (+10/–15%) single-phase, 50/60 Hz or 24V AC/DC. Refer to the product nameplate prior to applying control power. Connect control power to the controller at terminals 11 and 12. The control power requirement for the control module is 40 VA. For controllers rated 97...1000 A, control power is also required for the heatsink fans as defined in Table C. Depending on the specific application, additional control circuit transformer VA capacity may be required.

Table A
Heatsink Fan Power Requirements

SMC Rating	Heatsink Fan VA
97...360 A	45
500 A	145
650...1000 A	320

Control Terminals

Figure 1
SMC Dialog Plus Controller Control Terminals

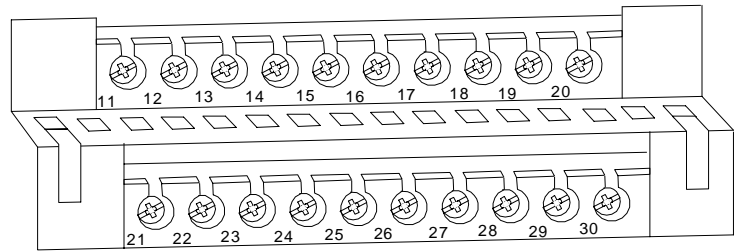
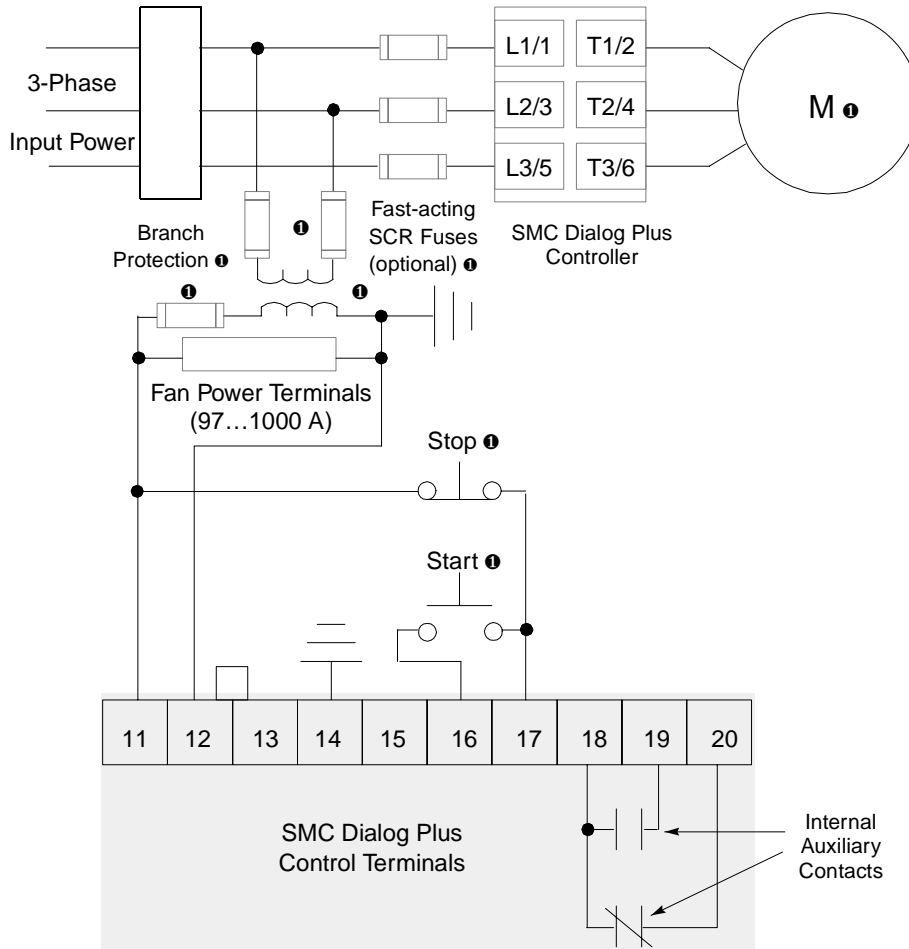

Table B
Control Terminal Designation

Terminal Number	Description
11	Control Power Input
12	Control Power Common
13	Controller Enable Input ❶
14	Logic Ground
15	Dual Ramp/Option Input ❶
16	Start Input ❶
17	Stop Input ❶
18	Auxiliary Relay Common
19	N.O. Auxiliary Contact #1
20	N.C. Auxiliary Contact #2
21	Not Used
22	Not Used
23	Not Used
24	Not Used
25	Converter Module Fanning Strip Connection ❶
26	Converter Module Fanning Strip Connection ❶
27	Converter Module Fanning Strip Connection ❶
28	Converter Module Fanning Strip Connection ❶
29	Auxiliary Contact #3
30	Auxiliary Contact #3

❶ Do not connect any additional loads to these terminals. These “parasitic” loads may cause problems with operation, which may result in false starting and stopping.

**Figure 2
Typical Wiring Diagram**



① Customer supplied.

**Figure 3
Heatsink Fan Wiring**

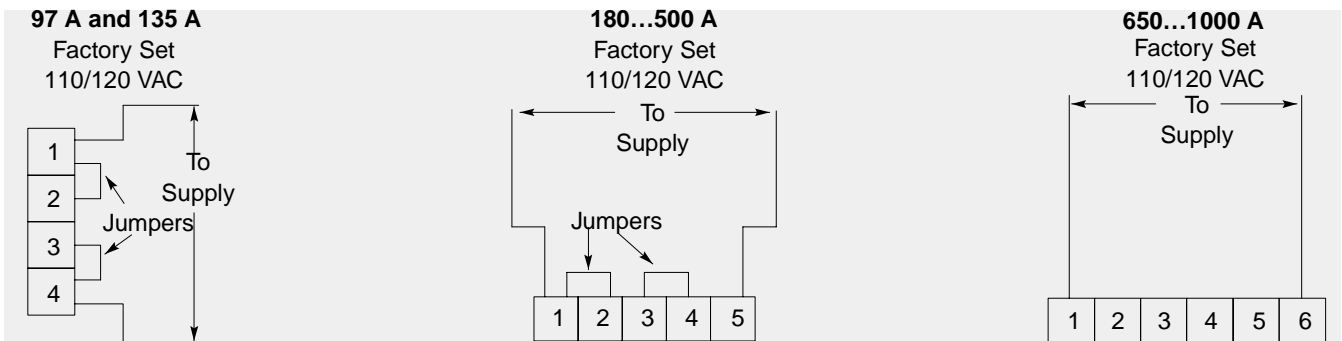





Refer to Chapter 3 of the *SMC Dialog Plus Controller User Manual* (Publication 150-5.3) for optional 220/240V AC fan power connections and other sample wiring diagrams. Chapter 7 of Publication 150-5.3 also provides typical wiring diagrams for the control options (for example, Pump Control).

Programming

The SMC Dialog Plus controller can be programmed with the built-in keypad and LCD display or with the optional Bulletin 1201 human interface modules. Parameters are organized in a four-level menu structure and divided into programming groups.

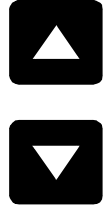
Keypad Description

	Escape	Pressing the <i>Escape</i> key causes the programming system to move up one level in the menu structure.
	Select	The <i>Select</i> key has two functions: <ul style="list-style-type: none"> Pressing the <i>Select</i> key alternately causes the top or bottom line of the display to become active (indicated by flashing first character). In parameter modification with series A FRN 3.00 or greater and series B human interface modules, <i>Select</i> moves the cursor from the least significant digit to the most significant.
	Up/ Down Arrows	These keys are used to increment and decrement a parameter value or to scroll through the different modes, groups, and parameters.
	Enter	When pressed, a mode or group will be selected, or a parameter value will be entered into memory. After a parameter value has been entered into memory, the top line of the display will automatically become active, allowing the user to scroll to the next parameter.

Programming (Cont.)

Figure 4
Menu Structure Hierarchy

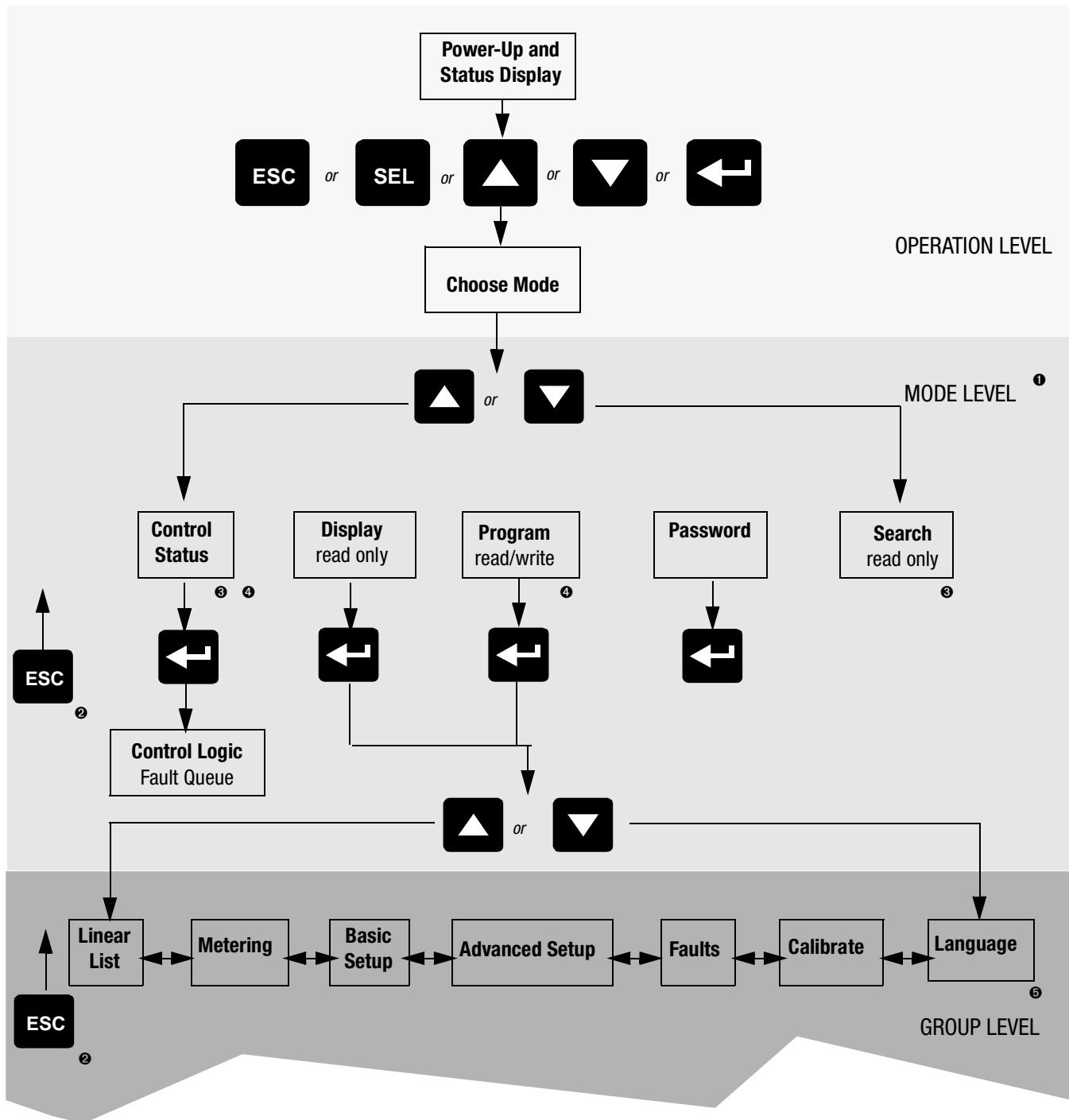

- ❶ The SMC Dialog Plus controller does not support EEPROM, Link, Process, or Start-up modes
- ❷ Steps back one level.
- ❸ Control Status and Search are only available when using a Series B Bulletin 1201 human interface module.
- ❹ Password protected.
- ❺ English is currently the only available language.

**Figure 4 (cont.)
Menu Structure Hierarchy**

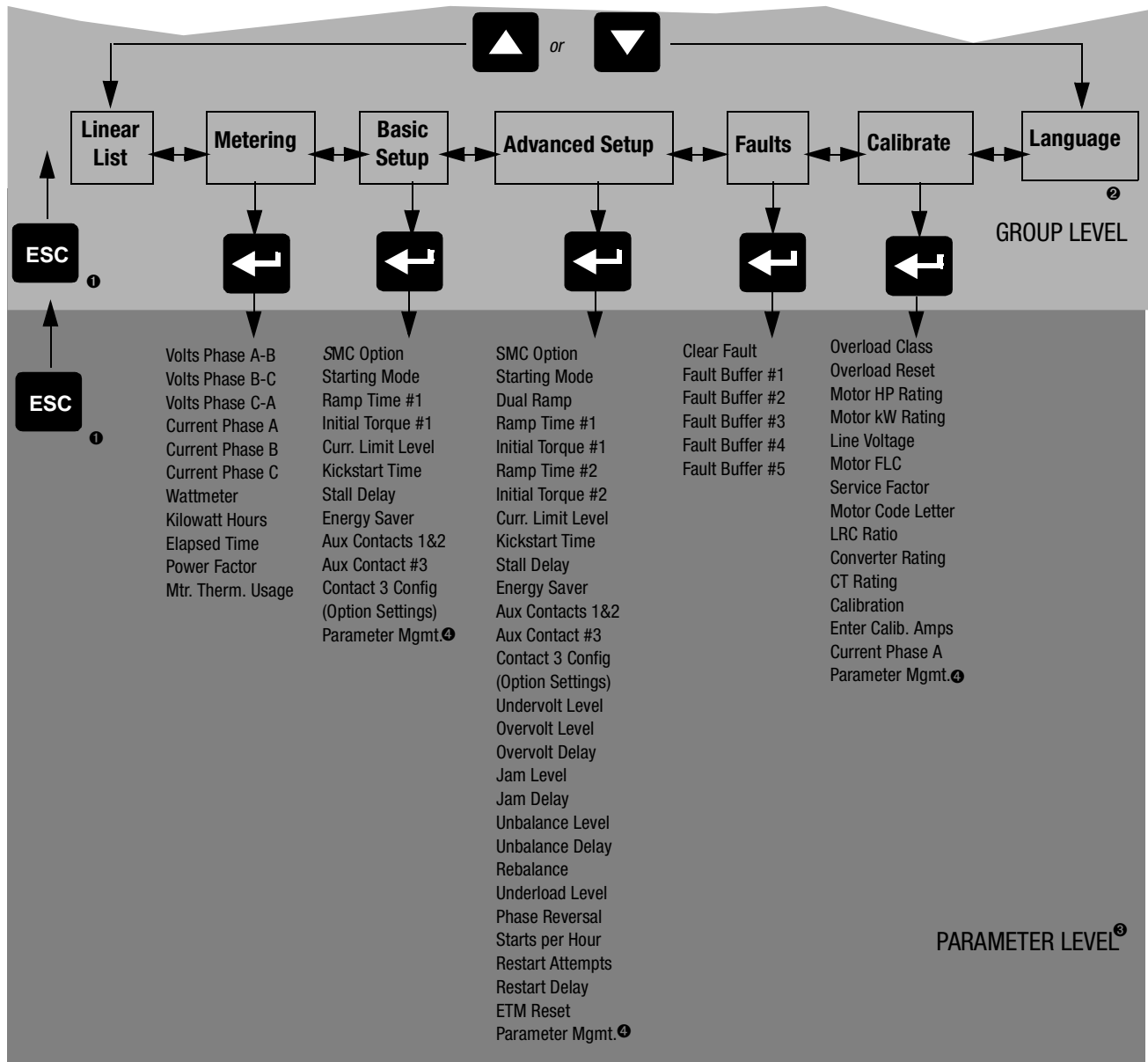

❶ Steps back one level.

❷ English is currently the only available language

❸ For further information on parameters, see Appendix B of the *SMC Dialog Plus User Manual*, Publication 150-5.3.

❹ For further information on parameter management, see page 8.

Programming (Cont.)

Factory Default Settings

The SMC Dialog Plus controller is pre-programmed with the settings listed in the table below.

Parameter	Setting
Starting Mode	Soft Start
Ramp Time	10 seconds
Initial Torque	70% of locked rotor torque
Kickstart	Off
Energy Saver	Off
Stall	Off
Phase Rebalance	Off
Auxiliary Contacts	Normal
Service Factor	1.15
Overload Class	Off
Line Voltage	480 volts
Motor FLC	1.0 amps
Motor HP Rating	0.0 HP
Motor Code Letter	G



ATTENTION: Overload protection in the SMC Dialog Plus controller is disabled from the factory. The user must program the desired overload trip class and motor full load current rating to achieve proper protection

Saving Programmed Values to Memory

After you have programmed the controller settings you **must** save them to the controller's memory. To do this, follow the steps below:

1. Scroll to Parameter Mgmt. This is the last parameter provided in the Basic Setup, Advanced Setup, and Calibrate programming groups.
2. Select the Store In EE option.
3. Press Enter.

Important: If control power is removed from the SMC Dialog Plus controller before you store the programmed values to memory, all programmed values will be lost.











Calibration

For current measurement accuracy, use the procedure below to calibrate the SMC Dialog Plus controller to the connected motor. A clamp-on ammeter, which provides a true rms measurement and has a published accuracy of $\pm 1\%$ (Fluke model 33 or equal), is required to perform this procedure.







Notes:

1. If you plan to use the Bulletin 825 converter module for current feedback to the SMC Dialog Plus controller, this calibration procedure is not necessary.
2. An unbalanced three-phase system may affect the accuracy of the calibration.
3. It is recommended that Parameter #36, Overload Class, is programmed to OFF during the calibration procedure.

Calibration requires the motor to be operated at full speed. Additionally, the motor must be connected to its load in order that the motor draw as near to its full load current (FLC) rating as possible. This is necessary so that maximum accuracy is achieved for current measurements at overload trip levels.

Description	Action	Display
1. Check all power and control wiring connections to the controller and motor. Apply a start command to the controller and check for motor rotation to full speed.	—	<div style="border: 1px solid black; padding: 2px; width: fit-content;"> AT SPEED ### AMPS </div>
2. Using the clamp-on ammeter, measure the three-phase motor currents. Place the ammeter around the phase with the largest current draw. ❶	—	<div style="border: 1px solid black; padding: 2px; width: fit-content;"> AT SPEED ### AMPS </div>
3. In the Calibrate group, scroll to the Calibration parameter.		<div style="border: 1px solid black; padding: 2px; width: fit-content;"> CALIBRATION OFF </div>
4. Monitor the clamp-on ammeter and verify that the motor current is stable. Press the Select key. Toggle the Up/Down keys to the Activate setting. Press the Enter key to accept. Monitor the ammeter display for the next 2 seconds and record the average value. During this time period, the SMC Dialog Plus controller samples motor response data.	   	<div style="border: 1px solid black; padding: 2px; width: fit-content;"> CALIBRATION ACTIVATE </div>
5. Access the next parameter using the Up key.		<div style="border: 1px solid black; padding: 2px; width: fit-content;"> ENTER CALIB. AMPS 0.0 AMPS </div>
6. Press the Select key. Enter the clamp-on meter value monitored in step 4. Press the Enter key to accept. The SMC Dialog Plus controller is now calibrated.	   	<div style="border: 1px solid black; padding: 2px; width: fit-content;"> ENTER CALIB. AMPS ### AMPS </div>

❶ The currents should measure a minimum of 70% of the motor's full load current rating in order to achieve the best results in accuracy.

Description	Action	Display
7. You can scroll to the next parameter to view the current measurement in phase A.		CURRENT PHASE A ###.# AMPS
8. Scroll to the next parameter to save the Calibrate group settings.		PARAMETER MGMT READY
9. Press the Select key. Scroll with the Up/Down keys to Store In EE selection. Press the Enter key to save the settings to EEPROM.	   	PARAMETER MGMT STORE IN EE



ATTENTION: After calibration is completed, program the desired overload class and save the setting to the controller's EEPROM.



ATTENTION: The method of current measurement is not applicable to the multi-motor installations or resistive heating loads. Utilization of the Bulletin 825 converter module is required for these applications if current measurement is required.

Communication

A serial interface port (called SCANport™) is provided as standard, and allows connection to a Bulletin 1201 human interface module or a variety of Bulletin 1203 communication modules.

Figure 5
SCANport Location

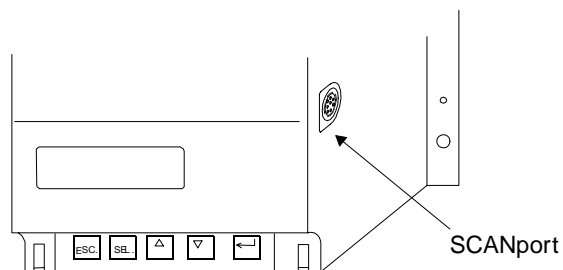

ATTENTION: Only one peripheral device can be connected to the SCANport. The maximum output current is 100 mA.

Human Interface Modules

The Bulletin 1201 human interface modules with control panels can start and stop the SMC Dialog Plus controller. However, the factory default settings disable control commands other than Stop through the serial communication port.

To enable motor control from a connected human interface module, you must take the following programming steps:

Series A

1. Enter into the Program mode.
2. Select the Linear List programming group.
3. Scroll to the Logic Mask parameter (number 85).
4. Program the Logic Mask parameter for a value of 4.
5. Press Enter.

Series B

1. Enter the Control Status mode.
2. Select the Enable option of Control Logic.
3. Press Enter.

Important: Control Logic must be disabled or the Logic Mask set to 0 prior to disconnecting a human interface module from the SMC Dialog Plus controller.

Reach us now at www.rockwellautomation.com

Wherever you need us, Rockwell Automation brings together leading brands in industrial automation including Allen-Bradley controls, Reliance Electric power transmission products, Dodge mechanical power transmission components, and Rockwell Software. Rockwell Automation's unique, flexible approach to helping customers achieve a competitive advantage is supported by thousands of authorized partners, distributors and system integrators around the world.

Americas Headquarters, 1201 South Second Street, Milwaukee, WI 53204, USA, Tel: (1) 414 382-2000, Fax: (1) 414 382-4444

European Headquarters SA/NV, avenue Herrmann Debroux, 46, 1160 Brussels, Belgium, Tel: (32) 2 663 06 00, Fax: (32) 2 663 06 40

Asia Pacific Headquarters, 27/F Citicorp Centre, 18 Whitfield Road, Causeway Bay, Hong Kong, Tel: (852) 2887 4788, Fax: (852) 2508 1846



**Rockwell
Automation**