



SLC 500™ Modular Chassis and Power Supplies

(Chassis Catalog Numbers: 1746-A4, -A7, -A10, -A13)

Power Supply Catalog Numbers: 1746-P1, -P2, -P3, -P4)

Product Data

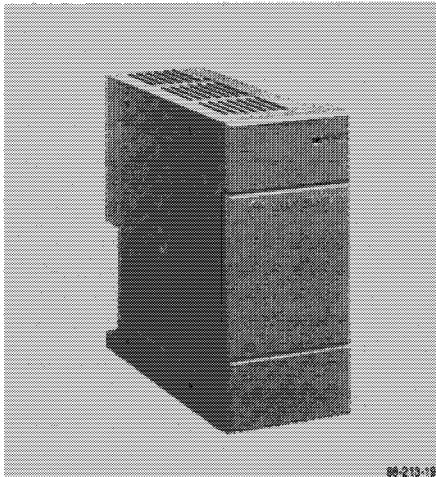

88-213-19

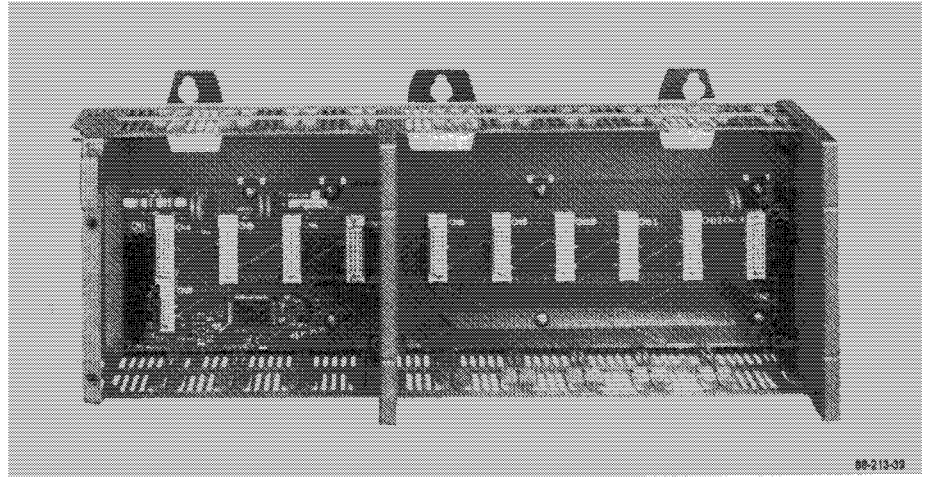

88-213-02

SLC 500™ modular chassis and power supplies provide flexibility in system configuration. By selecting the appropriate chassis, power supply, processor, and I/O modules you can create a controller system specifically designed for your application.

Four chassis sizes are available to suit your application needs. Choose from 4-slot, 7-slot, 10-slot, and 13-slot chassis based on your modular hardware component requirements.

Four power supplies are available to meet your system power requirements. There are three different AC power supplies and one DC power supply.

Features and Benefits of Chassis and Power Supplies

Chassis

The SLC™ 1746 modular chassis houses the processor and the I/O modules. Features and benefits of the modular chassis series include:

Feature	Benefit
Modules easily slide into chassis slots.	No tools are required for module installation.
Up to 3 chassis can be interconnected.	Locally the processor can address up to 30 slots.
Four chassis sizes are available to choose from.	Selection can be suited to your system I/O requirements.

Power Supplies

Each chassis requires a power supply to provide power to the processor and each I/O slot. You should consider future system expansion when selecting a power supply. Power supply features and benefits include:

Feature	Benefit
All power supplies have an LED that indicates proper supply power.	Monitoring this LED can tell you at a glance whether your supply is operating properly.
Supplies have a hold-up time (the time the system is operational during a brief power loss) typically between 20 milliseconds and 3 seconds.	Power supplies are designed to withstand brief power losses without affecting the operation of the system. Actual duration of the power supply hold-up time depends on the number, type, and state of the I/O modules.
On ac power supplies, you can select either 120V or 240V operation by setting a jumper.	No special wiring is required.

This product data supplies you with information you need to consider when setting up your control application. It provides specifications and dimension drawings for the SLC 1746 modular chassis and power supplies. It also provides worksheets that you can use to calculate the power supply best suited to your application and the amount of heat you can expect the components in your system to generate under normal operating conditions.

What's Inside...	Page
Hardware Overview	3
Specifications	5
System Layout Recommendations	9
Heat Dissipation	11
Dimension Drawings	15
Reference Table and Graphs	17
Allen-Bradley Support	20
Worksheets	21

Hardware Overview

Chassis Sizes

SLC modular chassis are available in the following slot sizes:

Description	Catalog Number	See Page
4-slot chassis	1746-A4	15
7-slot chassis	1746-A7	15
10-slot chassis	1746-A10	16
13-slot chassis	1746-A13	16

Chassis Interconnect Cables

You can connect up to three chassis using chassis interconnect cables. Chassis do not include interconnect cables. Below is a description of available cables:

Description	Catalog Number
152.4 mm (6 in.) Chassis Interconnect Cable – Use this ribbon cable when linking modular chassis up to 152.4 mm (6 in.) apart in an enclosure.	1746-C7
914.4 mm (36 in.) Chassis Interconnect Cable – Use this cable when linking modular chassis from 152.4 mm (6 in.) up to 914.4 mm (36 in.) apart in an enclosure.	1746-C9

Chassis Interconnect Cable Installation

Cables must exit the right side of the first chassis and enter the left side of the second chassis. Cables are keyed for proper installation.

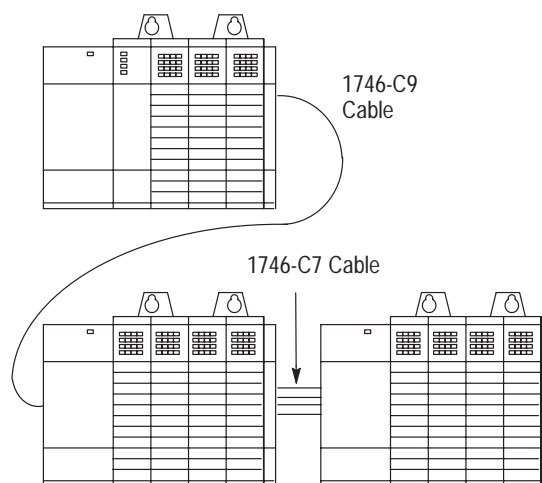

Power Supply Selection and Installation

When configuring a modular system, you must have an individual power supply for each chassis. The power supply provides power to the processor and each I/O card. Careful system configuration will result in the best performance. Excessive loading of the power supply can cause reduced power supply life or a power supply shutdown. The following pages can help you select the power supply best suited for each chassis in your modular SLC control system.

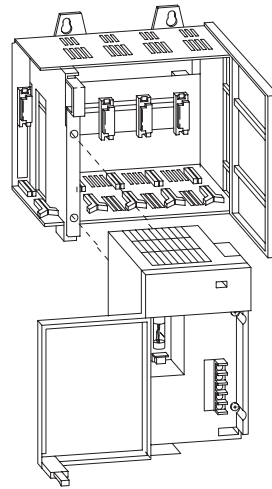

Note that the power supply does not occupy a slot in the chassis. It mounts on the left side with two screws.

Power Supply Specifications

Description	1746-P1	1746-P2	1746-P3	1746-P4	1746-P5
Line Voltage	85–132/ 170–265V ac 47–63 Hz	85–132/ 170–265V ac 47–63 Hz	19.2–28.8V dc	85–132/ 170–265V ac 47–63 Hz	90–146V dc
Typical Line Power Requirement	122 VA @ 120V ac 135 VA @ 240V ac	165 VA @ 120V ac 180 VA @ 240V ac	90 VA	190 VA @ 120V ac 230 VA @ 240V ac	85VA
Maximum Inrush Current	20A	20A	20A	45A	20A
Internal Current Capacity	2A at 5V dc 0.46A at 24V dc	5A at 5V dc 0.96A at 24V dc	3.6A at 5V dc 0.87A at 24V dc	10.0A at 5V dc 2.88A at 24V dc ^②	5A at 5V dc 0.96A at 24V dc
Fuse Protection ^①	1746-F1 or equivalent ^③	1746-F2 or equivalent ^④	1746-F3 or equivalent ^⑤	Non-replaceable fuse is soldered in place.	Non-replaceable fuse is soldered in place.
24V dc User Power Current Capacity	200 mA	200 mA	Not Applicable	1A ^②	200 mA
24V dc User Power Voltage Range	18–30V dc	18–30V dc	Not Applicable	20.4–27.6V dc	18–30V dc
Ambient Operating Temperature Rating	0°C to 60°C (32°F to 140°F) ^⑥			0°C to 60°C (32°F to 140°F) no derating	0°C to 60°C (32°F to 140°F) ^⑥
Storage Temperature	–40°C to 85°C (–40°F to 185°F)				
Humidity Rating	5–95% (non-condensing)				
Wiring	two #14 AWG wires per terminal (maximum)				
Certification	UL/CSA/CE				
Hazardous Environment Certification	Class I Division 2				

^① Power supply fuse is intended to guard against fire hazard due to short circuit conditions and may not protect the supply from damage under these conditions.

^② The combination of all output power (5 volt backplane, 24 volt backplane, and 24 volt user source) cannot exceed 70 Watts.

^③ Equivalent fuses: 250V-3A Fuse, Nagasawa ULCS-61ML-3, or BUSSMANN AGC 3

^④ Equivalent fuses: 250V-3A Fuse, SANO SOC SD4, or BUSSMANN AGC 3

^⑤ Equivalent fuses: 125V-5A Fuse, Nagasawa ULCS-61ML-5, or BUSSMAN AGC 5

^⑥ Current capacity derated 5% above 55°C.

Wiring, Input Voltage Selection, and Fuse Location

The power supply terminals accept two #14 AWG wires and are marked as shown in the figures on the following page. On ac power supplies, a jumper is provided to make the 120/240V selection. Place the jumper to match the input voltage. Note that the jumper location on the 1746-P4 supply is different from the jumper location on the P1 and P2 power supplies.

Fuse placement for 1746-P1, P2, and P3 supplies is shown below. Refer to the *Power Supply Specification* table on page 5 for fuse replacement information. Note that the 1746-P4 and -P5 power supplies fuse is non-replaceable.



ATTENTION: Make jumper selection before applying power. Hazardous voltage is present on exposed pins when power is applied.

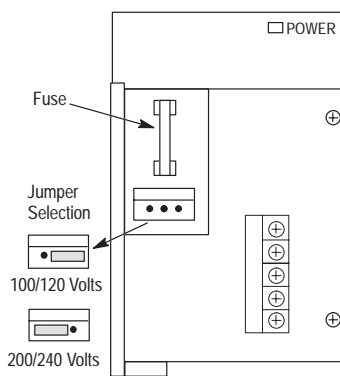

1746-P1 and -P2

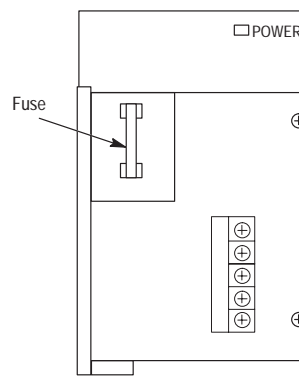
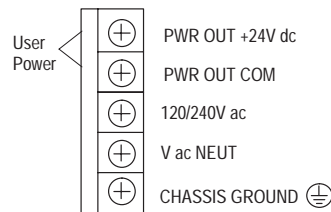

1746-P3

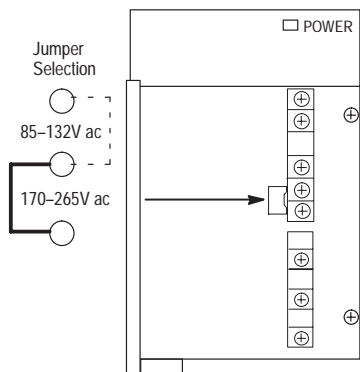
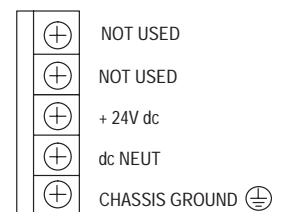

1746-P4

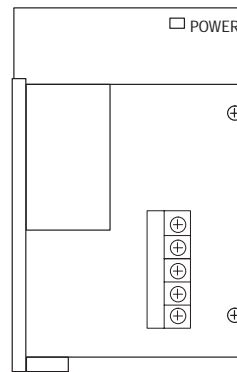
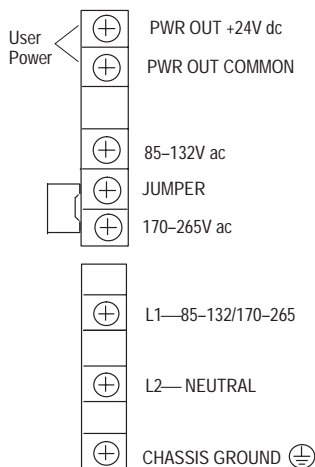

1746-P5

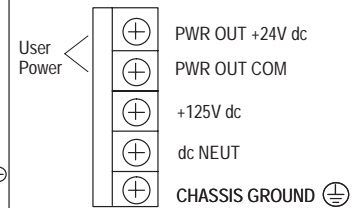

Power Supply Selection Example

Select a power supply for chassis 1 and chassis 2 in the control system below.
(The worksheet for this example is on page 8.)

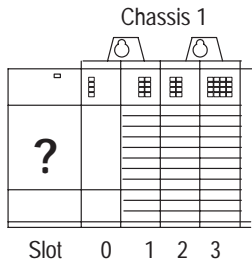
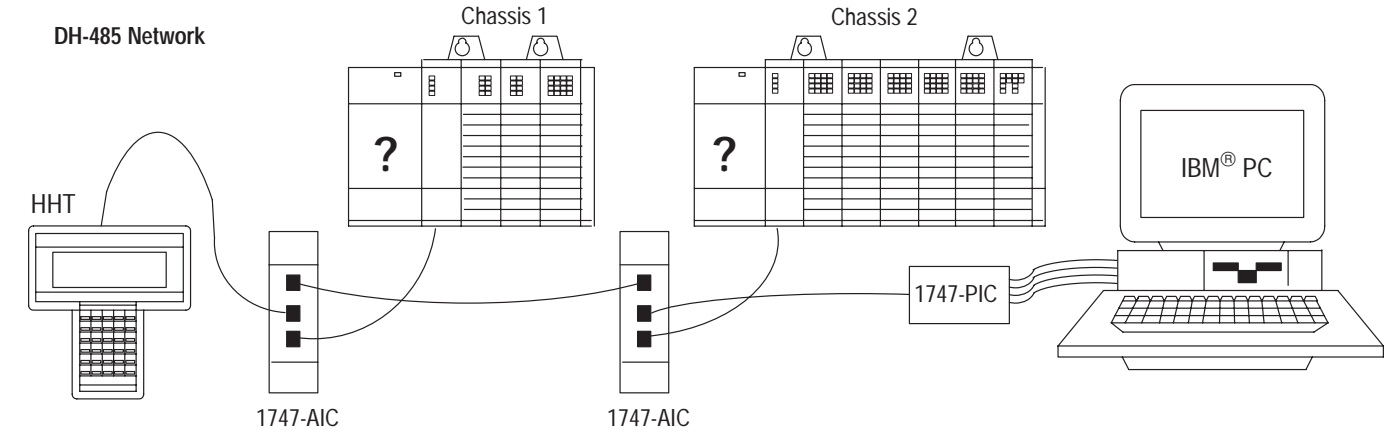

Slot Numbers	Description	Catalog Number	Power Supply at 5V dc (Amps)	Power Supply at 24V dc (Amps)
0	Processor Unit	1747-L511	0.35	0.105
1	Input Module	1747-IV8	0.05	NA
2	Transistor Output Module	1746-OB8	0.135	NA
3	Triac Output Module	1746-OA16	0.37	NA
Peripheral Device	Hand-Held Terminal	1747-PT1	NA	NA
Peripheral Device	Isolated Link Coupler	1747-AIC	NA	0.085
Total Current:			0.905	0.190 ^①

^① Power Supply 1746-P1 is sufficient for Chassis #1. The "Internal Current Capacity" for this power supply is 2 Amps at 5V dc, 0.46 Amps at 24V dc.

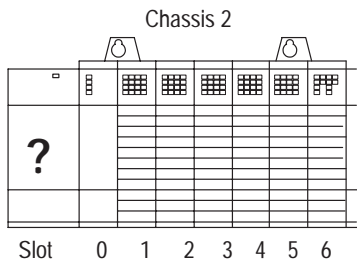

Slot Numbers	Description	Catalog Number	Power Supply at 5V dc (Amps)	Power Supply at 24V dc (Amps)
0	Processor Unit	1747-L514	0.35	0.105
1	Output Module	1746-OW16	0.17	0.180
2	Combination Module	1746-IO12	0.09	.07
3, 4, 5, 6	Analog Output Modules	1746-NO4I	0.22 (4 x 0.055)	0.780 (4 x 0.195)
Peripheral Device	Isolated Link Coupler	1747-AIC	NA	0.085
Peripheral Device	Interface Converter	1746-PIC	NA	NA
Total Current:			0.83	1.22 ^①

^① Power Supply 1746-P4 is sufficient for Chassis #2. The "Internal Current Capacity" for this power supply is 10 Amps at 5V dc, 2.88 Amps at 24V dc; not to exceed 70 Watts. (This configuration = 33.43 Watts, i.e., [5V x 0.83A] + [24V x 1.22A] = 33.43W)

Product Data

SLC 500™ Modular Chassis and Power Supplies

Example Worksheet for Selecting 1746 Power Supplies for the Example System

If you have a multiple chassis system, make copies of the *Worksheet for Selecting a Power Supply* found on page 21. For a detailed list of device load currents, refer to pages 17 and 18.

Procedure

- For each slot of the chassis that contains a module, list the slot number, the catalog number of the module, and its 5V and 24V maximum currents. Also include the power consumption of any peripheral devices that may be connected to the processor other than a DTAM™, HHT, or PIC — the power consumption of these devices is accounted for in the power consumption of the processor.

Chassis Number: 1

slot	Catalog Number	Maximum Currents	
		5V	24V
slot <u> 0 </u>	<u> L511 </u>	<u> 0.350 </u>	<u> 0.105 </u>
slot <u> 1 </u>	<u> IV8 </u>	<u> 0.050 </u>	<u> — </u>
slot <u> 2 </u>	<u> OB8 </u>	<u> 0.135 </u>	<u> — </u>
slot <u> 3 </u>	<u> OA16 </u>	<u> 0.370 </u>	<u> — </u>
slot <u> </u>	<u> </u>	<u> </u>	<u> </u>
slot <u> </u>	<u> </u>	<u> </u>	<u> </u>
slot <u> </u>	<u> </u>	<u> </u>	<u> </u>
slot <u> </u>	<u> </u>	<u> </u>	<u> </u>
Peripheral Device:	<u> AIC </u>	<u> — </u>	<u> 0.085 </u>

Chassis Number: 2

slot	Catalog Number	Maximum Currents	
		5V	24V
slot <u> 0 </u>	<u> L514 </u>	<u> 0.350 </u>	<u> 0.105 </u>
slot <u> 1 </u>	<u> OW16 </u>	<u> 0.170 </u>	<u> 0.180 </u>
slot <u> 2 </u>	<u> NO4I </u>	<u> 0.055 </u>	<u> 0.195 </u>
slot <u> 3 </u>	<u> NO4I </u>	<u> 0.055 </u>	<u> 0.195 </u>
slot <u> 4 </u>	<u> NO4I </u>	<u> 0.055 </u>	<u> 0.195 </u>
slot <u> 5 </u>	<u> NO4I </u>	<u> 0.055 </u>	<u> 0.195 </u>
slot <u> 6 </u>	<u> IO12 </u>	<u> 0.090 </u>	<u> 0.070 </u>
slot <u> </u>	<u> </u>	<u> </u>	<u> </u>
Peripheral Device:	<u> AIC </u>	<u> — </u>	<u> 0.085 </u>

- Add the power supply loading currents of all the system devices (at 5V and 24V).

Total Current: **0.905** | **0.190**

Total Current: **0.830** | **1.220**

When using the 1746-P4 power supply, use the formula below to calculate total power consumption of all the system devices (at 5V and 24V). Note that the 1746-P4 Chassis total power supply loading currents cannot exceed 70 Watts. If you are not using a 1746-P4 power supply, proceed to step 3.

The user current @ 24V listed below is for example only. The current required depends on the application.

<small>Total current @ 5V</small>	<small>Total current @ 24V</small>	<small>User Current @ 24V</small>	<small>Total Power</small>		<small>Total current @ 5V</small>	<small>Total current @ 24V</small>	<small>User Current @ 24V</small>	<small>Total Power</small>
(0.905)	(0.190)	(0.500)	= 21.085 W		(0.830)	(1.220)	(0.500)	= 45.43 W

- Compare the Total Current required for the chassis with the Internal Current Capacity of the power supplies. To select the proper power supply for your chassis, make sure that the power supply loading current for the chassis is *less than* the internal current capacity for the power supply, for both 5V and 24V loads.

Catalog Number	Internal Current Capacity	
	5V	24V
Catalog Number 1746-P1	2.0A	0.46A
Catalog Number 1746-P2	5.0A	0.96A
Catalog Number 1746-P3	3.6A	0.87A
Catalog Number 1746-P4	10.0A	2.88A (70 Watts maximum)
Catalog Number 1746-P5	5.0A	0.96A

Required Power Supply for this Chassis: 1746- P1

Required Power Supply for this Chassis: 1746- P4

Consider future system expansion when selecting a power supply.

System Layout Recommendations

Selecting Enclosures

The enclosure protects the equipment from atmospheric contamination. Standards established by the National Electrical Manufacturer's Association (NEMA) and International Electrotechnical Commission (IEC) define enclosure types based on the degree of protection an enclosure will provide. Select a NEMA- or IEC-rated enclosure that suits your application and environment. The enclosure should be equipped with a disconnect device. To calculate the heat dissipation of your controller, refer to *Calculating Heat Dissipation* on page 12.

Spacing Considerations

Follow the recommended minimum spacing shown below to allow for convection cooling within the enclosure. Cooling air in the enclosure must be kept within a range of 0°C to +60°C (+32°F to +140°F).

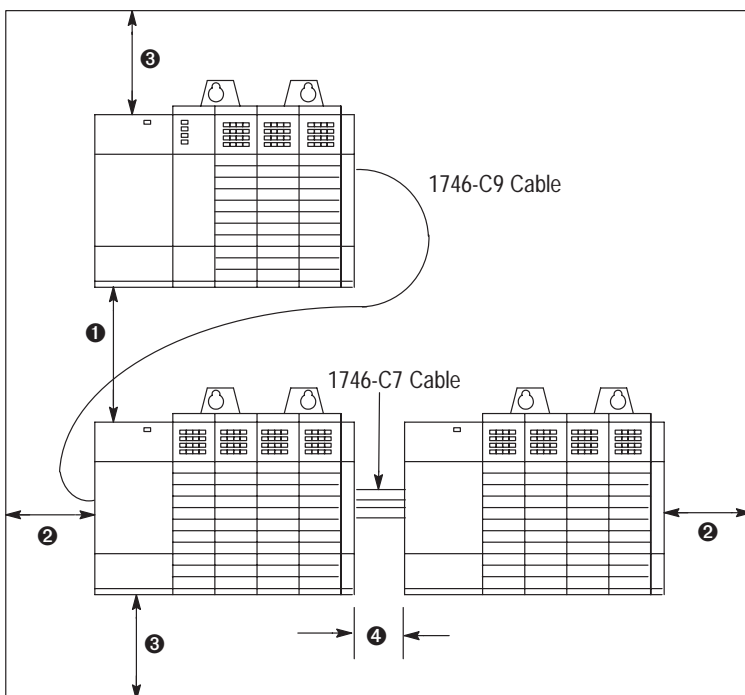

Recommended Spacing

- ❶ 15.3 to 20 cm (6 to 8 inches) when using the 1746-C9 cable
Note: When making a vertical connection between two A13 chassis with a 1746-C9 cable, you must limit the space to 15.3 cm (6 inches) for the C-9 cable to reach from chassis to chassis.
- ❷ Greater than 10.2 cm (4 inches)
- ❸ Greater than 15.3 cm (6 inches)
- ❹ 7.7 to 10.2 cm (3 to 4 inches) when using the 1746-C7 cable

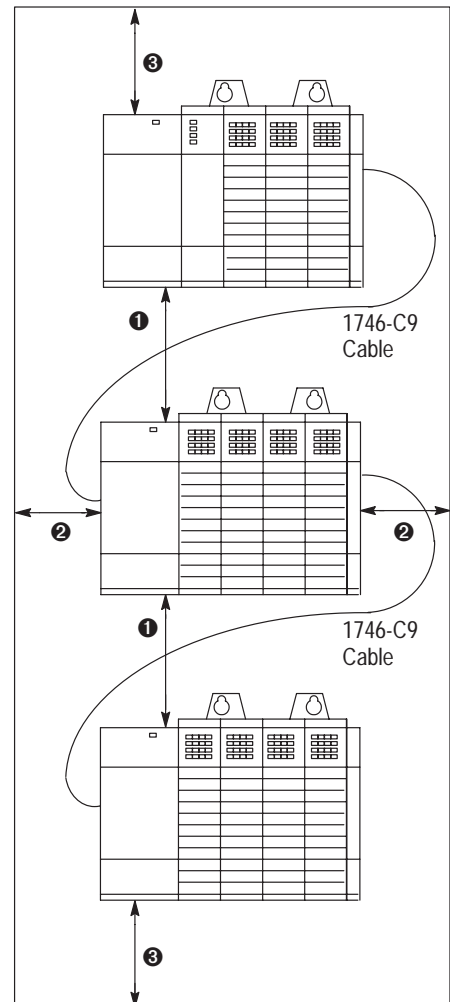

Grounding

In solid-state control systems, grounding helps limit the effects of noise due to electromagnetic interference (EMI). Ground connections should run from the chassis and power supply on each controller and expansion unit to the ground bus. Exact connections will differ between applications. An authoritative source on grounding requirements for most installations is the National Electrical Code. Also, refer to *Allen-Bradley Industrial Automation Grounding and Wiring Guidelines*, Publication Number 1770-4.1.

The figure below shows you how to run ground connections from the chassis to the ground bus. Each chassis in the figure uses a different grounding method. Both methods are acceptable, but we recommend use of the ground bus because it reduces the electrical resistance at the connection.

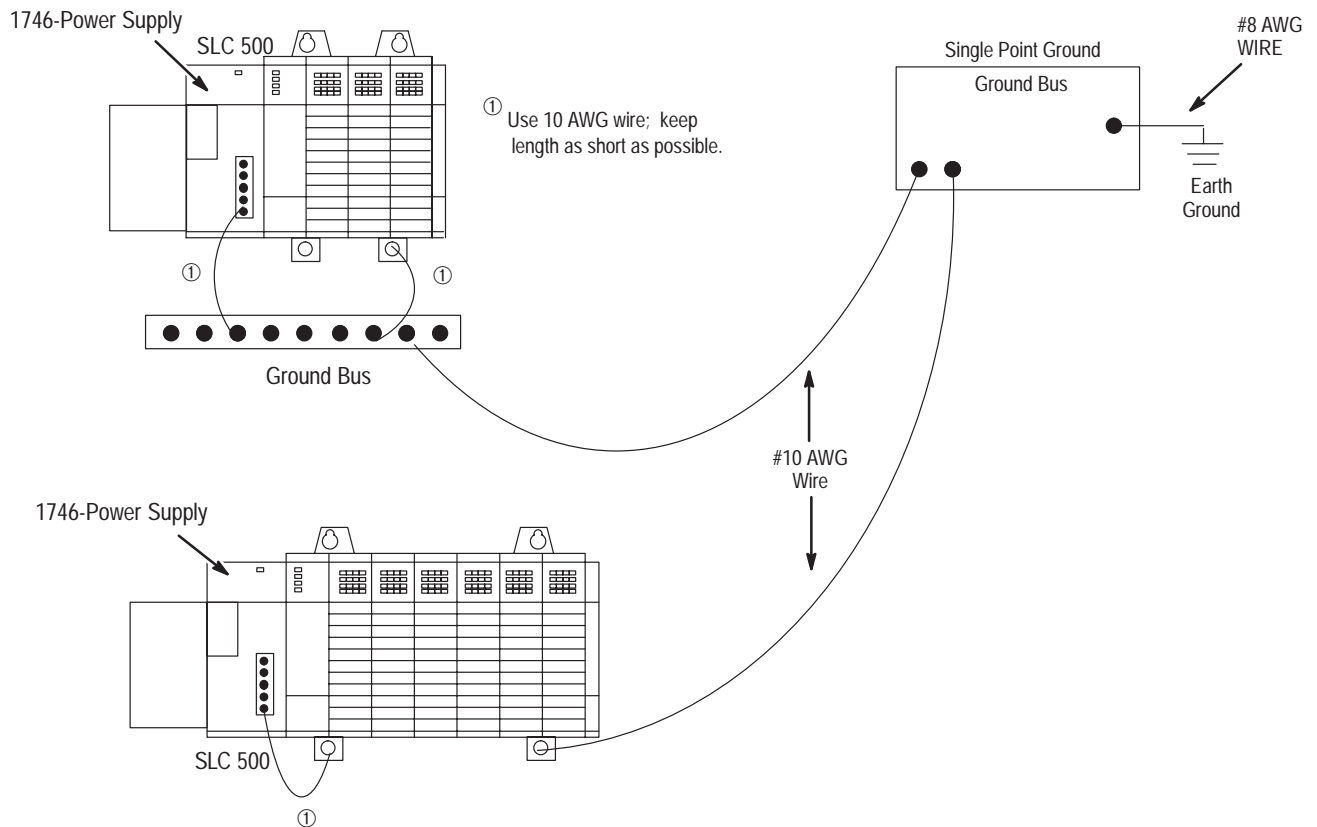

Special Considerations in dc Applications



ATTENTION: Any voltage applied to the 1746-P3 dc NEUT terminal will be present at the SLC logic ground and the processor DH-485 port. To prevent unwanted potentials across the logic ground of the controller and/or damage to the SLC chassis, the dc NEUTRAL of the external dc power source must be either isolated from the SLC chassis ground, or connected to earth ground. See the figure below:

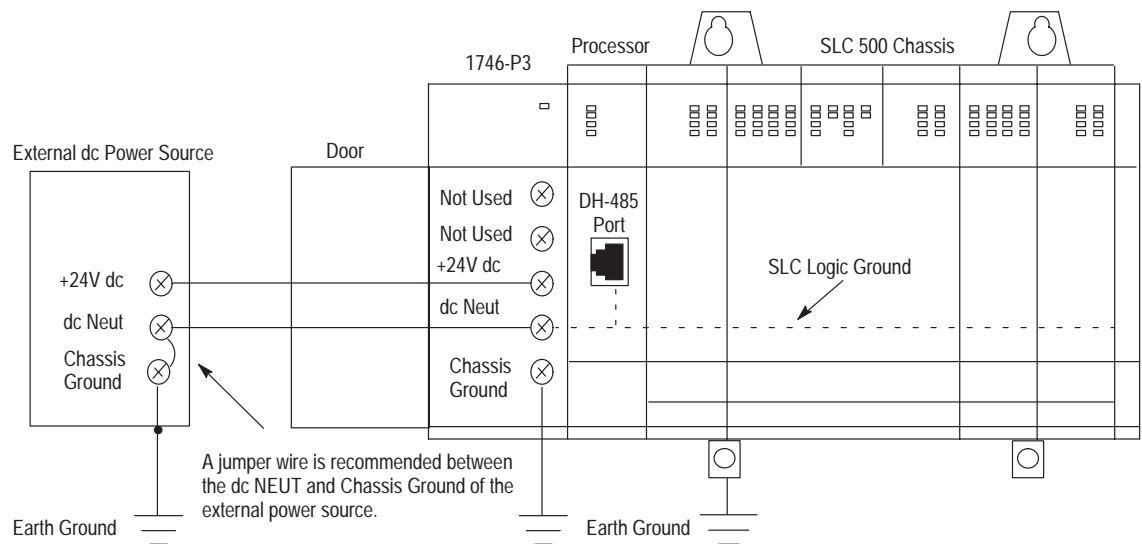

Heat Dissipation

Preventing Excessive Heat

For most applications, normal convection cooling will keep the controller components within the specified operating range (0–60°C). Proper spacing of components within the enclosure is usually sufficient for heat dissipation.

In some applications, a substantial amount of heat is produced by other equipment inside or outside the enclosure. In this case, place blower fans inside the enclosure to assist in air circulation and to reduce “hot spots” near the controller.

Additional cooling provisions might be necessary when high ambient temperatures are encountered.

Important: Do not bring unfiltered outside air into the enclosure. It may introduce harmful contaminants that could cause improper operation or damage to components. In extreme cases, you may need to use air conditioning to protect against heat build-up within the enclosure.

If you suspect heat build-up may be a problem, you can calculate the heat dissipation of your SLC control system. The following information can help you to make this calculation.

Calculating Heat Dissipation

To calculate the heat dissipation of your SLC controller you must consider two things:

- the maximum heat dissipated (with field power applied) by the processor, all I/O and specialty modules, and any peripheral devices for each chassis.
- the heat dissipated by the power supply. This is determined by the maximum load on the power supply of the processor, each I/O and specialty module, peripheral device, and device drawing power directly off the power supply via the “POWER OUT” terminals.

You calculate maximum heat dissipation by using one of these methods:

- calculated watts method
- total watts method

Use **calculated watts** if you know exactly how many outputs and inputs on each card will be active at any given time. This method will give you a lower, more accurate heat dissipation calculation than the total watts method. With this method, use the formula below for calculating the heat dissipation of each module. Then use these values in step 1 of the *Example Worksheet for Calculating Heat Dissipation* on page 14.

$(\text{points energized} \times \text{watts per point}) + \text{minimum watts} = \text{heat dissipation of module}$

Use **total watts** if you are not sure how many points on a module will be energized at any time. Total watts is the watts per point (with all points energized) plus the minimum watts. Total watts generated by each module are provided in the table on pages 17 and 18.

Once you have determined which method you will use to calculate the heat dissipation of your modules, see the *Example Worksheet for Calculating Heat Dissipation* on page 14. This worksheet shows you how to calculate the heat dissipation for the example SLC control system on page 13.

Example Heat Dissipation Calculation

If your controller consisted of the following hardware components, you would calculate heat dissipation as shown in the worksheet on page 14.

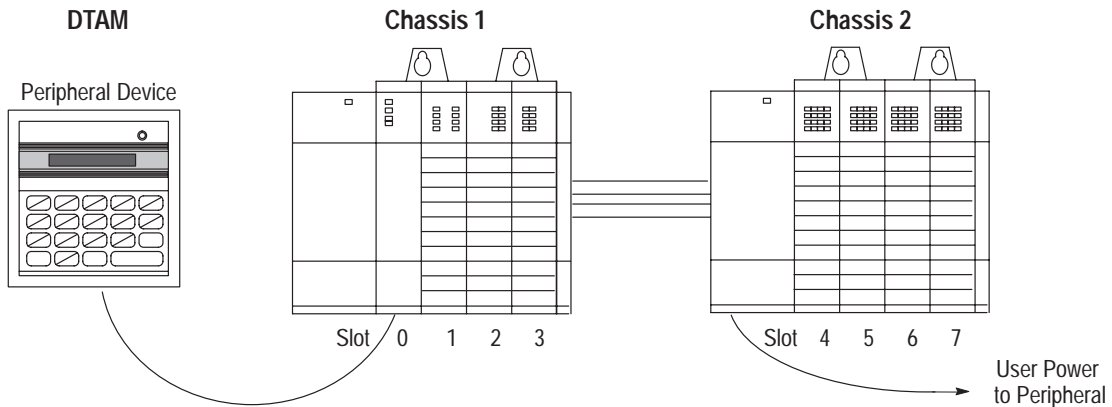

The following table details the total watts dissipated by the modules and peripheral devices in the above SLC 500 controller. The numbers were taken from the tables on pages 17 and 18.

Chassis 1				Chassis 2			
Slot Number	Catalog Number	Min. Watts	Max. Watts	Slot Number	Catalog Number	Min. Watts	Max. Watts
0	1747-L511	1.75	1.75	4	1746-IA16	0.425	4.800
1	1746-BAS	3.750	3.80	5	1746-IA16	0.425	4.800
2	1746-IA8	0.250	2.40	6	1746-OW16	5.170	5.500 ^①
3	1746-OV8	0.675	6.90	7	1746-OW16	5.170	5.700
Peripheral Device	1747-DTAM	2.500	2.50	NA	NA	NA	NA
User Power to Peripheral	NA	NA	NA	NA	NA	2.400 ^②	NA

① This output card uses 5.5 Watts because only 10 points are on at any one time. Using the calculated watts formula — (number of points energized x watts per point) + minimum watts = heat dissipation of module — the calculated watts for the 1746-OW16 module is 5.5W: (10 points X .033) + 5.17 = 5.5W.

② The user power on the 1746-P1 power supply for Chassis 2 is being used to power a peripheral (100 mA at 24V dc).

Dimension Drawings

4-Slot Modular Chassis

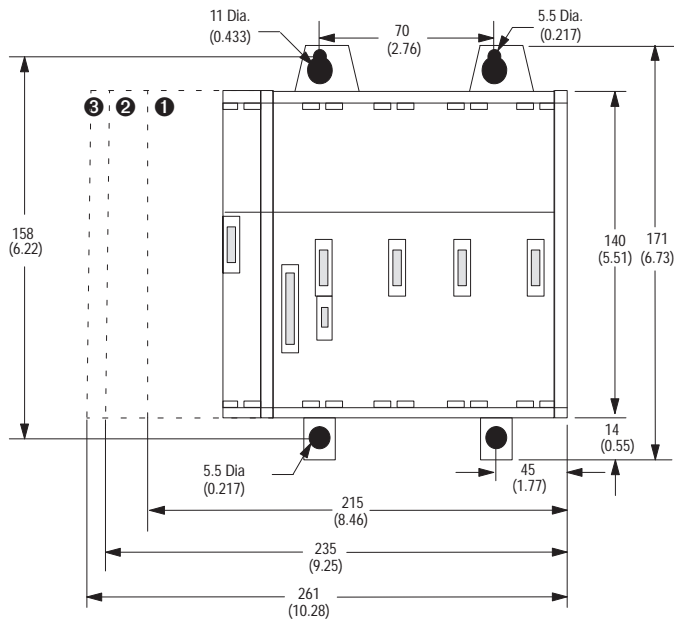

Front View

millimeters
(inches)

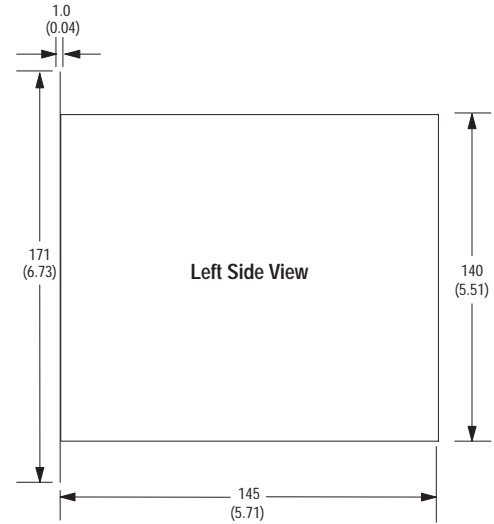

Left Side View

7-Slot Modular Chassis

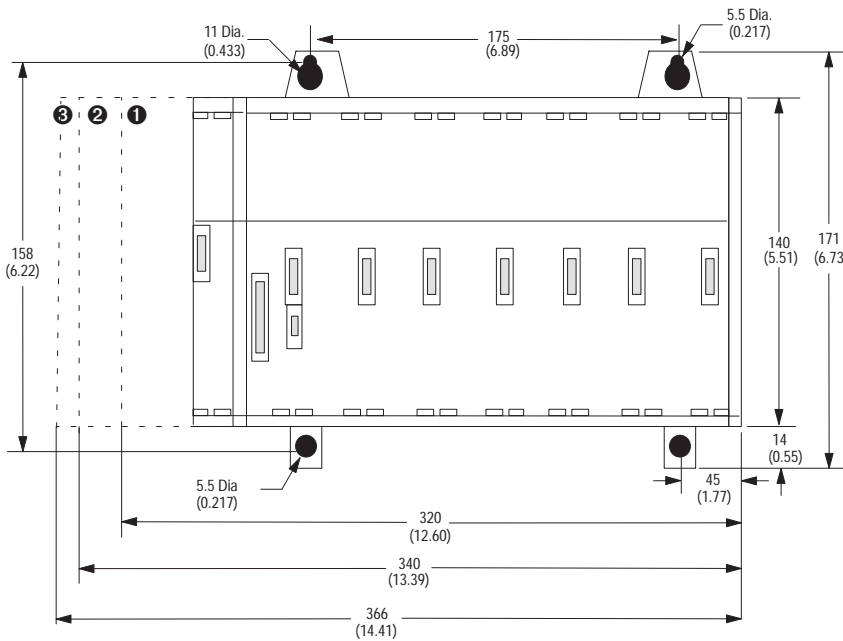

Front View

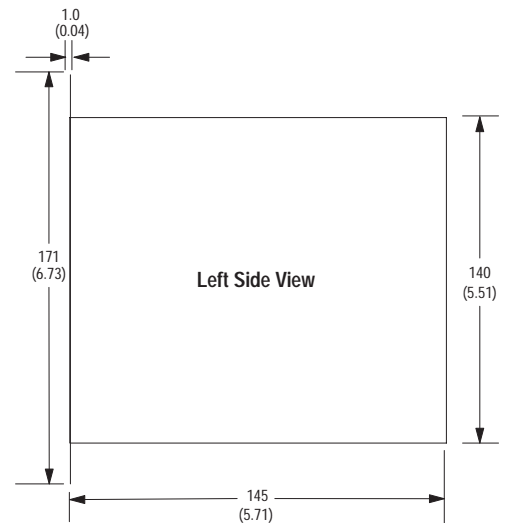

Left Side View

- ① Dimensions for power supply catalog number 1746-P1
- ② Dimensions for power supply catalog number 1746-P2, -P3, and -P5
- ③ Dimensions for power supply catalog number 1746-P4

Product Data

SLC 500™ Modular Chassis and Power Supplies

10-Slot Modular Chassis

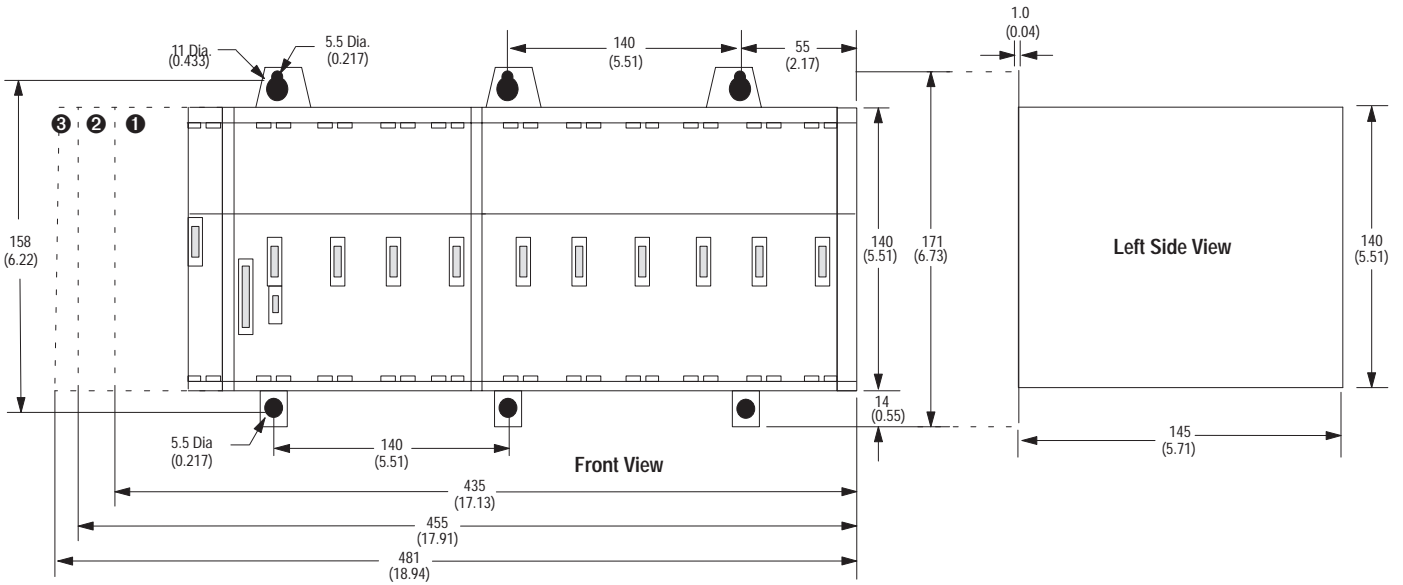

13-Slot Modular Chassis

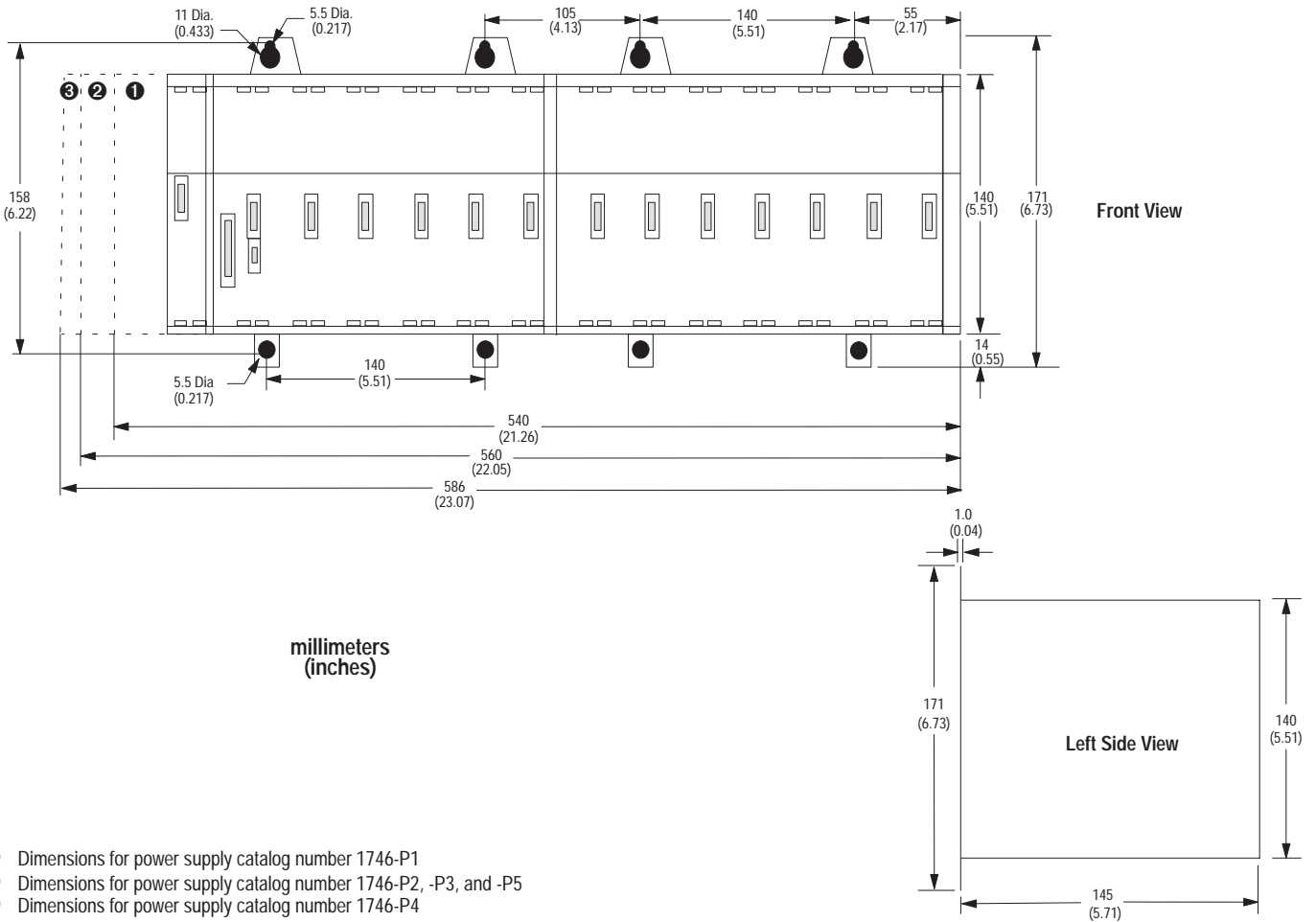

- ① Dimensions for power supply catalog number 1746-P1
- ② Dimensions for power supply catalog number 1746-P2, -P3, and -P5
- ③ Dimensions for power supply catalog number 1746-P4

Reference Table and Graphs Power Supply Loading Reference Table

Use the table below to calculate the power supply loading and heat dissipation for each chassis in your SLC modular application. Definitions of some of the terms used in the table are provided on the next page.

Hardware Component	Catalog Numbers	Maximum Current in Amps at 5V	Maximum Current in Amps at 24V	Watts per Point	Minimum Watts	Total Watts
Processors	1747-L511	0.350	0.105	NA	1.75	1.75
	1747-L514	0.350	0.105	NA	1.75	1.75
	1747-L524	0.350	0.105	NA	1.75	1.75
	1747-L532	0.500	0.175	NA	2.90	2.90
	1747-L541	1.000	0.200	NA	4.00	4.00
	1747-L542	1.000	0.200	NA	4.00	4.00
	1747-L543	1.000	0.200	NA	4.00	4.00
Input Modules	1746-IA4	0.035	-	0.270	0.175	1.30
	1746-IA8	0.050	-	0.270	0.250	2.40
	1746-IA16	0.085	-	0.270	0.425	4.80
	1746-IB8	0.050	-	0.200	0.250	1.90
	1746-IB16	0.085	-	0.200	0.425	3.60
	1746-IB32	0.106	-	0.200	0.530	6.90
	1746-IC16	0.085	-	0.220	0.425	3.95
	1746-IG16	0.140	-	0.020	0.700	1.00
	1746-IH16	0.085	-	0.320	0.675	3.08
	1746-IM4	0.035	-	0.350	0.175	1.60
	1746-IM8	0.050	-	0.350	0.250	3.10
	1746-IM16	0.085	-	0.350	0.425	6.00
	1746-IN16	0.085	-	0.350	0.425	6.00
	1746-ITB16	0.085	-	0.200	0.425	3.625
	1746-ITV16	0.085	-	0.200	0.425	3.625
	1746-IV8	0.050	-	0.200	0.250	1.90
	1746-IV16	0.085	-	0.200	0.425	3.60
1746-IV32	0.106	-	0.200	0.530	6.90	
Output Modules	1746-OA8	0.185	-	1.000	0.925	9.00
	1746-OA16	0.370	-	0.462	1.850	9.30
	1746-OAP12	0.370	-	1.000	1.850	10.85
	1746-OB8	0.135	-	0.775	0.675	6.90
	1746-OB16	0.280	-	0.338	1.400	7.60
	1746-OB32	0.452	-	0.078	2.260	4.80
	1746-OBP8	0.135	-	0.300	0.675	3.08
	1746-OBP16	0.250	-	0.310	1.250	6.21
	1746-OG16	0.180	-	0.033	0.900	1.50
	1746-OV8	0.135	-	0.775	0.675	6.90
	1746-OV16	0.270	-	0.388	1.400	7.60
	1746-OV32	0.452	-	0.078	2.260	4.80
	1746-OVP16	0.250	-	0.310	1.250	6.21
	1746-OW4	0.045	0.045	0.133	1.310	1.90
	1746-OW8	0.085	0.090	0.138	2.590	3.70
	1746-OW16	0.170	0.180	0.033	5.170	5.70
	1746-OX8	0.085	0.090	0.825	2.590	8.60

Hardware Component	Catalog Numbers	Maximum Current in Amps at 5V	Maximum Current in Amps at 24V	Watts per Point	Minimum Watts	Total Watts
Input & Output Modules	1746-IO4	0.030	0.025	0.270 — per input pt. 0.133 — per output pt.	0.750	1.60
	1746-IO8	0.060	0.045	0.270 — per input pt. 0.133 — per output pt.	1.380	3.00
	1746-IO12	0.090	0.070	0.270 — per input pt. 0.133 — per output pt.	2.130	4.60
Specialty Modules	1747-ASB	0.375	–	NA	1.875	1.875
	1746-BAS	0.150	0.040 ^①	NA	3.750	3.800
	1747-DCM	0.360	–	NA	1.800	1.800
	1747-DSN	0.900	–	NA	4.500	4.500
	1746-FIO4I	0.055	0.150	NA	3.760	3.800
	1746-FIO4V	0.055	0.120	NA	3.040	3.100
	1746-HSCE	0.320	–	NA	1.600	1.600
	1747-KE	0.150	0.040 ^①	NA	3.750	3.800
	1746-NI4	0.025	0.085	NA	2.170	2.20
	1746-NIO4I	0.055	0.145	NA	3.760	3.80
	1746-NIO4V	0.055	0.115	NA	3.040	3.10
	1746-NO4I	0.055	0.195	NA	4.960	5.00
	1746-NO4V	0.055	0.145	NA	3.780	3.80
	1746-NR4	0.050	0.050	NA	1.500	1.500
	1747-NT4	0.060	0.040	NA	0.800	0.800
1747-SN	0.900	–	NA	4.500	4.500	
Peripheral Devices	1747-AIC	0	0.085	NA	2.000	2.000
	1747-DTAM	0	②	NA	2.500	2.500
	1747-PT1 Series A & B	0	②	NA	2.500	2.500
	1747-PIC	0	②	NA	2.000	2.000

① When using the BAS or KE modules to supply power to an AIC, the AIC draws its power through the module. Add 0.085A (the current loading for the AIC) to the BAS or KE module's power supply loading value at 24V dc.

② The 24V dc loading values of the HHT, PIC, and DTAM are included in the 24V dc loading value of the processor.

NA (Not Applicable)

Watts per point — the heat dissipation that can occur in each field wiring point when energized at nominal voltage.

Minimum watts — the amount of heat dissipation that can occur when there is no field power present.

Total watts — the watts per point plus the minimum watts (with all points energized).

Power Supply Heat Dissipation Graphs

Use the graphs below for determining the power supply dissipation in step 2 of the *Example Worksheet for Calculating Heat Dissipation*.

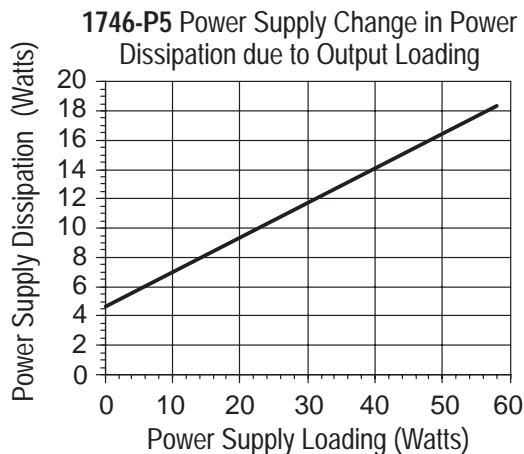
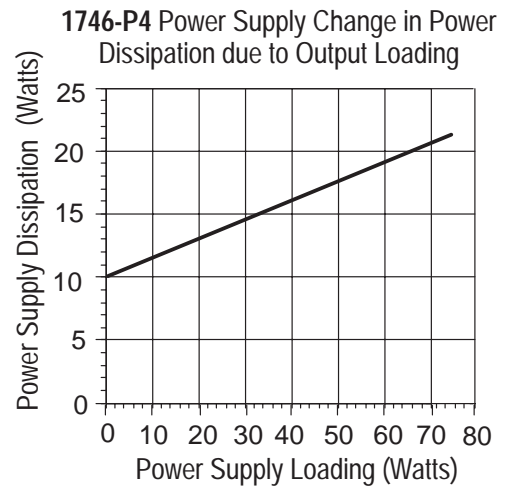
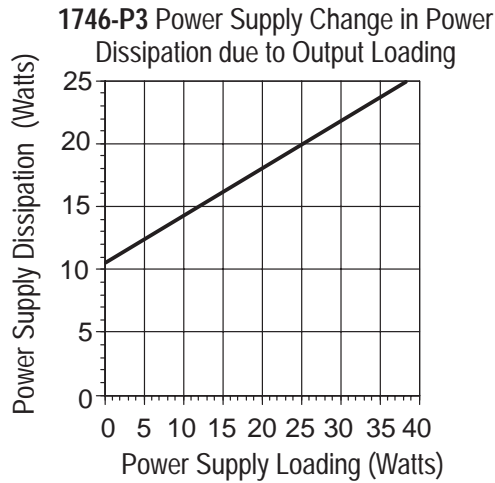
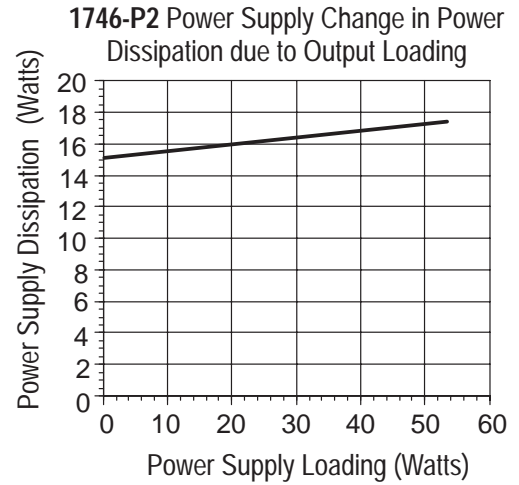
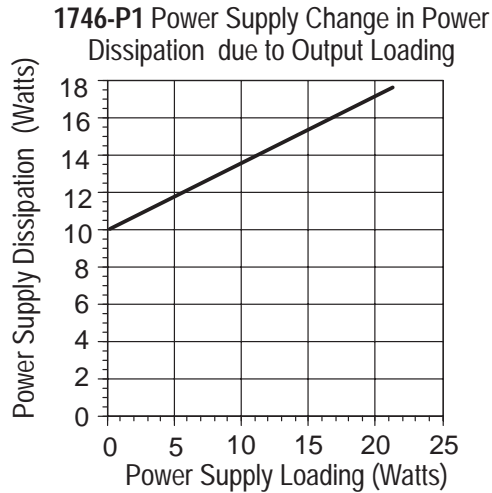

Allen-Bradley Support

In today's competitive environment, when you buy any product, you expect that product to meet your needs. You also expect the manufacturer of that product to back it up with the kind of customer service and product support that will prove you made a wise purchase.

As the people who design, engineer, and manufacture your Industrial Automation Control equipment, Allen-Bradley has a vested interest in your complete satisfaction with our products and services.

Allen-Bradley offers support services worldwide, with over 75 Sales/Support Offices, 512 authorized Distributors and 260 authorized Systems Integrators located throughout the United States alone, plus Allen-Bradley representatives in every major country in the world.

Contact your local Allen-Bradley representative for:

- sales and order support
- product technical training
- warranty support
- support service agreements

Worksheets

Blank Worksheet for Selecting a 1746 Power Supply

(For a detailed list of device load currents, refer to *SLC 500 Modular Chassis and Power Supplies*, Publication Number 1746-2.38, pages 17 and 18.)

Procedure	Required Power Supply																																																																										
<p>1. For each slot of the chassis that contains a module, list the slot number, the catalog number of the module, and its 5V and 24V maximum currents. Also include the power consumption of any peripheral devices that may be connected to the processor other than a DTAM, HHT, or PIC — the power consumption of these devices is accounted for in the power consumption of the processor.</p> <p>Chassis Number: _____</p> <table style="width: 100%; border-collapse: collapse; margin-top: 10px;"> <thead> <tr> <th rowspan="2"></th> <th rowspan="2">Catalog Number</th> <th colspan="2">Maximum Currents</th> </tr> <tr> <th>5V</th> <th>24V</th> </tr> </thead> <tbody> <tr><td>slot _____</td><td>_____</td><td>_____</td><td>_____</td></tr> <tr><td>slot _____</td><td>_____</td><td>_____</td><td>_____</td></tr> <tr><td>slot _____</td><td>_____</td><td>_____</td><td>_____</td></tr> <tr><td>slot _____</td><td>_____</td><td>_____</td><td>_____</td></tr> <tr><td>slot _____</td><td>_____</td><td>_____</td><td>_____</td></tr> <tr><td>slot _____</td><td>_____</td><td>_____</td><td>_____</td></tr> <tr><td>slot _____</td><td>_____</td><td>_____</td><td>_____</td></tr> <tr><td>slot _____</td><td>_____</td><td>_____</td><td>_____</td></tr> <tr><td>slot _____</td><td>_____</td><td>_____</td><td>_____</td></tr> <tr><td>slot _____</td><td>_____</td><td>_____</td><td>_____</td></tr> <tr><td>slot _____</td><td>_____</td><td>_____</td><td>_____</td></tr> <tr><td>slot _____</td><td>_____</td><td>_____</td><td>_____</td></tr> <tr><td>slot _____</td><td>_____</td><td>_____</td><td>_____</td></tr> <tr><td>slot _____</td><td>_____</td><td>_____</td><td>_____</td></tr> <tr><td>slot _____</td><td>_____</td><td>_____</td><td>_____</td></tr> <tr><td>slot _____</td><td>_____</td><td>_____</td><td>_____</td></tr> <tr><td>slot _____</td><td>_____</td><td>_____</td><td>_____</td></tr> </tbody> </table> <p>Peripheral Device: _____</p>		Catalog Number	Maximum Currents		5V	24V	slot _____	_____	_____	_____	slot _____	_____	_____	_____	slot _____	_____	_____	_____	slot _____	_____	_____	_____	slot _____	_____	_____	_____	slot _____	_____	_____	_____	slot _____	_____	_____	_____	slot _____	_____	_____	_____	slot _____	_____	_____	_____	slot _____	_____	_____	_____	slot _____	_____	_____	_____	slot _____	_____	_____	_____	slot _____	_____	_____	_____	slot _____	_____	_____	_____	slot _____	_____	_____	_____	slot _____	_____	_____	_____	slot _____	_____	_____	_____	
			Catalog Number	Maximum Currents																																																																							
	5V	24V																																																																									
slot _____	_____	_____	_____																																																																								
slot _____	_____	_____	_____																																																																								
slot _____	_____	_____	_____																																																																								
slot _____	_____	_____	_____																																																																								
slot _____	_____	_____	_____																																																																								
slot _____	_____	_____	_____																																																																								
slot _____	_____	_____	_____																																																																								
slot _____	_____	_____	_____																																																																								
slot _____	_____	_____	_____																																																																								
slot _____	_____	_____	_____																																																																								
slot _____	_____	_____	_____																																																																								
slot _____	_____	_____	_____																																																																								
slot _____	_____	_____	_____																																																																								
slot _____	_____	_____	_____																																																																								
slot _____	_____	_____	_____																																																																								
slot _____	_____	_____	_____																																																																								
slot _____	_____	_____	_____																																																																								
<p>2. Add the power supply loading currents of all the system devices (at 5V and 24V).</p> <p style="text-align: center;">Total Current: _____</p> <p style="font-size: small; margin-top: 10px;"><i>When using the 1746-P4 power supply, use the formula below to calculate total power consumption of all the system devices (at 5V and 24V). Note that the 1746-P4 Chassis total power supply loading currents cannot exceed 70 Watts. If you are not using a 1746-P4 power supply, proceed to step 3.</i></p> <table style="margin-left: auto; margin-right: auto; text-align: center;"> <tr> <td style="font-size: x-small;">Total current @ 5V</td> <td style="font-size: x-small;">Total current @ 24V</td> <td style="font-size: x-small;">User Current @ 24V</td> <td style="font-size: x-small;">Total Power</td> </tr> <tr> <td>(<input style="width: 40px;" type="text"/> x 5V)</td> <td>+ (<input style="width: 40px;" type="text"/> x 24V)</td> <td>+ (<input style="width: 40px;" type="text"/> x 24V)</td> <td>= <input style="width: 40px;" type="text"/> W</td> </tr> </table>	Total current @ 5V	Total current @ 24V	User Current @ 24V	Total Power	(<input style="width: 40px;" type="text"/> x 5V)	+ (<input style="width: 40px;" type="text"/> x 24V)	+ (<input style="width: 40px;" type="text"/> x 24V)	= <input style="width: 40px;" type="text"/> W																																																																			
Total current @ 5V	Total current @ 24V	User Current @ 24V	Total Power																																																																								
(<input style="width: 40px;" type="text"/> x 5V)	+ (<input style="width: 40px;" type="text"/> x 24V)	+ (<input style="width: 40px;" type="text"/> x 24V)	= <input style="width: 40px;" type="text"/> W																																																																								
<p>3. Compare the Total Current required for the chassis with the Internal Current Capacity of the power supplies. To select the proper power supply for your chassis, make sure that the power consumption for the chassis is <i>less than</i> the internal current capacity for the power supply, for both 5V and 24V loads.</p> <table style="margin-left: auto; margin-right: auto; text-align: center; margin-top: 10px;"> <thead> <tr> <th rowspan="2"></th> <th colspan="2">Internal Current Capacity</th> </tr> <tr> <th>5V</th> <th>24V</th> </tr> </thead> <tbody> <tr> <td>Catalog Number 1746-P1</td> <td>2.0A</td> <td>0.46A</td> </tr> <tr> <td>Catalog Number 1746-P2</td> <td>5.0A</td> <td>0.96A</td> </tr> <tr> <td>Catalog Number 1746-P3</td> <td>3.6A</td> <td>0.87A</td> </tr> <tr> <td>Catalog Number 1746-P4</td> <td>10.0A</td> <td>2.88A (70 Watts maximum)</td> </tr> <tr> <td>Catalog Number 1746-P5</td> <td>5.0A</td> <td>0.96A</td> </tr> </tbody> </table>		Internal Current Capacity		5V	24V	Catalog Number 1746-P1	2.0A	0.46A	Catalog Number 1746-P2	5.0A	0.96A	Catalog Number 1746-P3	3.6A	0.87A	Catalog Number 1746-P4	10.0A	2.88A (70 Watts maximum)	Catalog Number 1746-P5	5.0A	0.96A																																																							
		Internal Current Capacity																																																																									
	5V	24V																																																																									
Catalog Number 1746-P1	2.0A	0.46A																																																																									
Catalog Number 1746-P2	5.0A	0.96A																																																																									
Catalog Number 1746-P3	3.6A	0.87A																																																																									
Catalog Number 1746-P4	10.0A	2.88A (70 Watts maximum)																																																																									
Catalog Number 1746-P5	5.0A	0.96A																																																																									
For this chassis, you need the following power supply.	1746-																																																																										

Consider future system expansion when selecting a power supply.

Notes

SLC, SLC 500, and DTAM are trademarks of Allen-Bradley Company, Inc.
IBM is a registered trademark of International Business Machines Corporation



ALLEN-BRADLEY
A ROCKWELL INTERNATIONAL COMPANY

Allen-Bradley has been helping its customers improve productivity and quality for 90 years. A-B designs, manufactures and supports a broad range of control and automation products worldwide. They include logic processors, power and motion control devices, man-machine interfaces and sensors. Allen-Bradley is a subsidiary of Rockwell International, one of the world's leading technology companies.



With major offices worldwide.

Algeria • Argentina • Australia • Austria • Bahrain • Belgium • Brazil • Bulgaria • Canada • Chile • China, PRC • Colombia • Costa Rica • Croatia • Cyprus • Czech Republic • Denmark • Ecuador • Egypt • El Salvador • Finland • France • Germany • Greece • Guatemala • Honduras • Hong Kong • Hungary • Iceland • India • Indonesia • Israel • Italy • Jamaica • Japan • Jordan • Korea • Kuwait • Lebanon • Malaysia • Mexico • New Zealand • Norway • Oman • Pakistan • Peru • Philippines • Poland • Portugal • Puerto Rico • Qatar • Romania • Russia-CIS • Saudi Arabia • Singapore • Slovakia • Slovenia • South Africa, Republic • Spain • Switzerland • Taiwan • Thailand • The Netherlands • Turkey • United Arab Emirates • United Kingdom • United States • Uruguay • Venezuela • Yugoslavia

World Headquarters, Allen-Bradley, 1201 South Second Street, Milwaukee, WI 53204 USA, Tel: (1) 414 382-2000 Fax: (1) 414 382-4444