

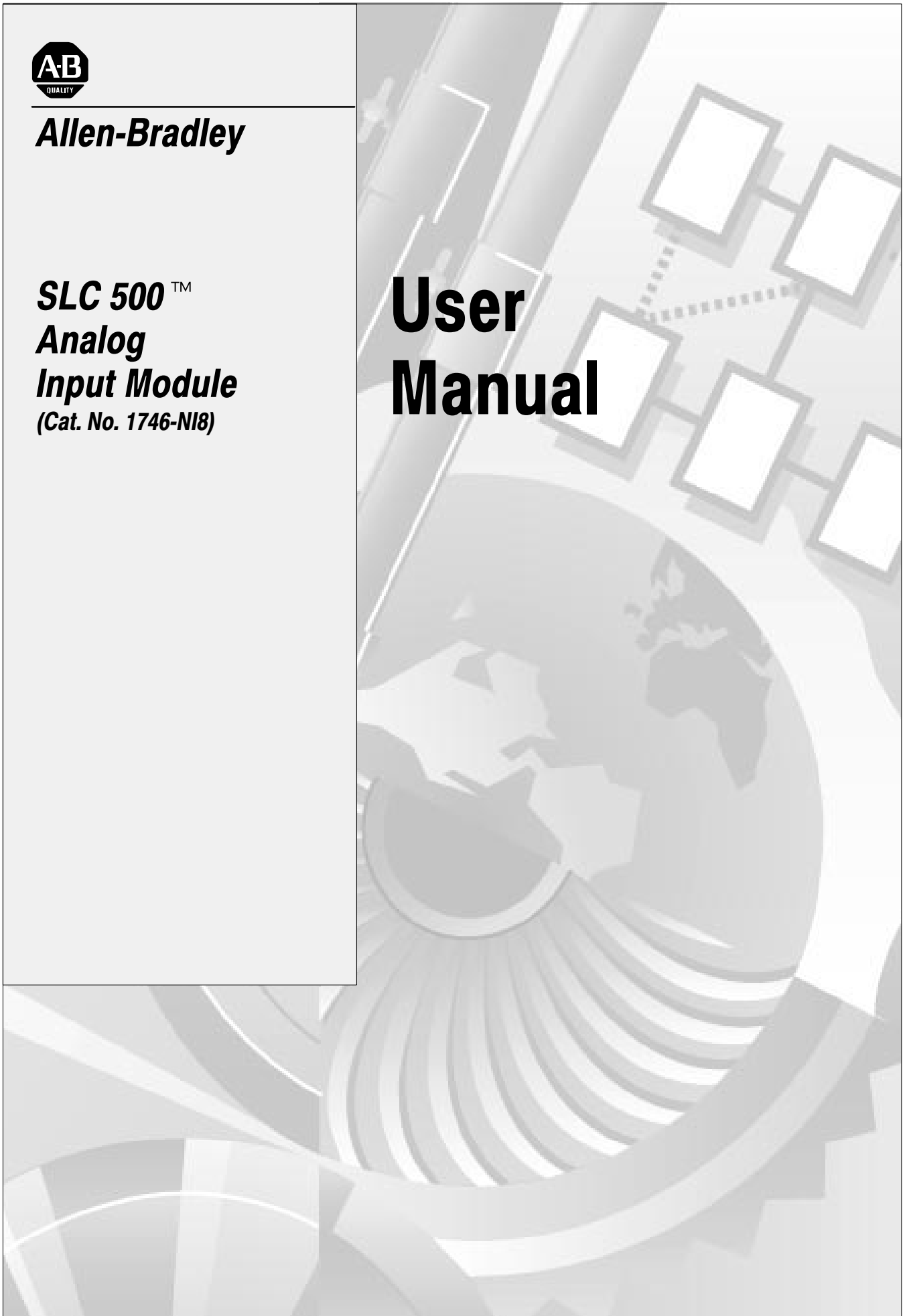

**Allen-Bradley**

**SLC 500™**  
**Analog**  
**Input Module**  
*(Cat. No. 1746-NI8)*

# User Manual



## Important User Information

Because of the variety of uses for the products described in this publication, those responsible for the application and use of this control equipment must satisfy themselves that all necessary steps have been taken to assure that each application and use meets all performance and safety requirements, including any applicable laws, regulations, codes and standards.

The illustrations, charts, sample programs and layout examples shown in this guide are intended solely for purposes of example. Since there are many variables and requirements associated with any particular installation, Allen-Bradley does not assume responsibility or liability (to include intellectual property liability) for actual use based upon the examples shown in this publication.

Allen-Bradley publication SGI-1.1, *Safety Guidelines for the Application, Installation, and Maintenance of Solid-State Control* (available from your local Allen-Bradley office), describes some important differences between solid-state equipment and electromechanical devices that should be taken into consideration when applying products such as those described in this publication.

Reproduction of the contents of this copyrighted publication, in whole or in part, without written permission of Allen-Bradley Company, Inc., is prohibited.

Throughout this manual we use notes to make you aware of safety considerations:



**ATTENTION:** Identifies information about practices or circumstances that can lead to personal injury or death, property damage or economic loss.

---

Attention statements help you to:

- identify a hazard
- avoid the hazard
- recognize the consequences

**Important:** Identifies information that is critical for successful application and understanding of the product.

# Table of Contents

---

<b>Important User Information</b> .....	<b>-1</b>
<b>Preface</b> .....	<b>P-1</b>
Who Should Use this Manual .....	P-1
Purpose of this Manual .....	P-1
Contents of this Manual .....	P-2
Related Documentation .....	P-3
Common Techniques Used in this Manual .....	P-4
Allen-Bradley Support .....	P-4
Local Product Support .....	P-4
Technical Product Assistance .....	P-4
Your Questions or Comments on this Manual .....	P-4
<b>Overview</b> .....	<b>1-1</b>
General Description .....	1-1
Hardware Features .....	1-2
General Diagnostic Features .....	1-3
System Overview .....	1-3
System Operation .....	1-3
Module Operation .....	1-4
Module Calibration .....	1-4
<b>Quick Start for Experienced Users</b> .....	<b>2-1</b>
Required Tools and Equipment .....	2-1
Procedures .....	2-2
<b>Installation and Wiring</b> .....	<b>3-1</b>
Electrostatic Damage .....	3-1
1746-NI8 Power Requirements .....	3-1
Modular Chassis Considerations .....	3-2
Module Location in Chassis .....	3-2
Fixed Expansion Chassis Considerations .....	3-2
General Considerations .....	3-3
Compliance to European Union Directives .....	3-3
EMC Directive .....	3-3
Module Installation and Removal .....	3-4
Terminal Block Removal .....	3-4
Switch Settings to Select Voltage or Current Input .....	3-4
Module Installation Procedure .....	3-5
Module Removal Procedure .....	3-6

Terminal Wiring . . . . .	3-6
Terminal Block . . . . .	3-6
Wiring Single-Ended and Differential Inputs . . . . .	3-7
Wiring Guidelines . . . . .	3-9
Input Devices . . . . .	3-9
Wiring Input Devices to the 1746-NI8 . . . . .	3-10
<b>Preliminary Operating Considerations . . . . .</b>	<b>4-1</b>
Module ID Code . . . . .	4-1
Class 1 and Class 3 Interface . . . . .	4-2
Module Addressing . . . . .	4-2
Class 1 Memory Map . . . . .	4-2
Class 3 Memory Map . . . . .	4-3
Output Image – Configuration Words . . . . .	4-3
Input Image – Data Words and Status Words . . . . .	4-4
Module Update Time . . . . .	4-5
Channel Turn-On, Turn-Off, and Reconfiguration Times . . . . .	4-6
Response to Slot Disabling . . . . .	4-6
Input Response . . . . .	4-6
Output Response . . . . .	4-6
Channel Filter Frequency Selection . . . . .	4-7
Channel Step Response . . . . .	4-7
Channel Frequency . . . . .	4-7
Channel Cut-Off Frequency . . . . .	4-7
Aliasing Frequency . . . . .	4-8
Noise Rejection . . . . .	4-10
<b>Channel Configuration, Data, and Status . . . . .</b>	<b>5-1</b>
Channel Configuration . . . . .	5-1
Channel Configuration Procedure . . . . .	5-2
Select Input Type (Bits 0-2) . . . . .	5-3
Select Data Format (Bits 3-5) . . . . .	5-3
Select Open Circuit State (Bits 6 and 7) . . . . .	5-3
Select Channel Filter Frequency (Bits 8-10) . . . . .	5-4
Select Channel Enable (Bit 11) . . . . .	5-4
Unused Bits (Bits 12-15) . . . . .	5-5
Channel Data Word . . . . .	5-5
Scaling the Channel Data Word . . . . .	5-6
Data Type Descriptions . . . . .	5-6
Using Scaled-for-PID and Proportional Counts . . . . .	5-7
Scaling Examples . . . . .	5-8
Engineering Units to “Real” Units . . . . .	5-8
Scaled-for-PID to “Real” Units . . . . .	5-9
Proportional Counts to “Real” Units . . . . .	5-9
1746-NI4 Data Format Units to “Real” Units . . . . .	5-10

---

User Defined Limits Data Format to “Real” Units .....	5-10
Channel Status Checking .....	5-11
Input Type Status (Bits 0-2) .....	5-13
Data Format Type Status (Bits 3-5) .....	5-13
Open Circuit Type Status (Bits 6 and 7) .....	5-13
Channel Filter Frequency (Bits 8-10) .....	5-13
Channel Status (Bit 11) .....	5-13
Open Circuit Error (Bit 12) .....	5-14
Over-Range Error (Bit 13) .....	5-14
Under-Range Error (Bit 14) .....	5-14
Configuration Error (Bit 15) .....	5-14
<b>Ladder Logic Configuration Examples .....</b>	<b>6-1</b>
Initial Programming .....	6-1
Procedure .....	6-2
Interfacing to the PID Instruction .....	6-3
Monitoring Channel Status Bits (Class 3 Mode Only) .....	6-4
<b>Module Diagnostics and Troubleshooting .....</b>	<b>7-1</b>
Module Operation vs. Channel Operation .....	7-1
Power-Up Diagnostics .....	7-1
Channel Diagnostics .....	7-1
LED Indicators .....	7-2
Channel Status LEDs (Green) .....	7-3
Invalid Channel Configuration .....	7-3
Open-Circuit Detection .....	7-3
Out-Of-Range Detection .....	7-3
Module Status LED (Green) .....	7-4
Troubleshooting Flowchart .....	7-5
Replacement Parts .....	7-6
Contacting Allen-Bradley .....	7-6
<b>Application Examples .....</b>	<b>8-1</b>
Application Setup – Display a Current (amperage) Value .....	8-1
Basic Example .....	8-1
Device Configuration .....	8-1
Channel Configuration .....	8-2
Channel Configuration Worksheet (With Settings Established for Channel 0) .....	8-2
Program Listing .....	8-3
Data File .....	8-3
Application Setup – Display Amps, PSI, and Liquid Level .....	8-4
Supplementary Example .....	8-4
Device Configuration .....	8-4
Channel Configuration .....	8-5

Channel Configuration Worksheet (With Settings Established for Channels 0–4) .....	8–6
Program Set Up and Operation Summary .....	8–7
Program Listing .....	8–8
Data File .....	8–10
<b>Specifications</b> .....	<b>A–1</b>
Electrical Specifications .....	A–1
Physical Specifications .....	A–1
Environmental Specifications .....	A–2
Input Specifications .....	A–2
<b>Configuration Worksheet</b> .....	<b>B–1</b>
<b>Converting from 1746-NI4 to 1746-NI8</b> .....	<b>C–1</b>
Module ID Code .....	C–1
Addressing .....	C–2
Channel Configuration .....	C–3
Ladder Program .....	C–3
<b>Two’s Complement Binary Numbers</b> .....	<b>D–1</b>
Positive Decimal Values .....	D–1
Negative Decimal Values .....	D–2
<b>Glossary</b> .....	<b>G–1</b>

---

# Preface

Read this preface to familiarize yourself with the rest of the manual. This preface covers the following topics:

- who should use this manual
- the purpose of this manual
- contents of this manual
- related documentation
- common techniques used in this manual
- Allen-Bradley support

## Who Should Use this Manual

Use this manual if you are responsible for the design, installation, programming, or maintenance of an automation control system that uses Allen-Bradley small logic controllers.

You should have a basic understanding of SLC 500 products. You should understand electronic process control and be able to interpret the ladder logic instructions required to generate the electronic signals that control your application.

If you do not, contact your local Allen-Bradley representative for the proper training before using this product.

## Purpose of this Manual

This manual is a learning and reference guide for the 1746-NI8 Analog Input Module. It contains the information you need to install, wire, and configure the module. It also provides diagnostic and troubleshooting information, and application examples.

## Contents of this Manual

Chapter	Title	Content
	Preface	Describes the purpose, background, and scope of this manual. Also specifies the audience for whom this manual is intended and gives directions to using Allen-Bradley support services. Provides listing of related documentation.
1	Overview	Provides a hardware and system overview. Explains and illustrates the theory behind the input module.
2	Quick Start for Experienced Users	Serves as a <i>Quick Start Guide</i> for the experienced user.
3	Installation and Wiring	Provides installation information and wiring guidelines.
4	Preliminary Operating Considerations	Gives you the background information you need to understand how to address and configure the module for optimum operation as well as how to make changes once the module is in a run state.
5	Channel Configuration, Data, and Status	Examines the channel configuration word and the channel status word, bit by bit, and explains how the module uses configuration data and generates status during operation.
6	Ladder Programming Examples	Gives an example of the ladder logic required to define the channel for operation. Also includes representative examples for unique programming requirements such as PID.
7	Module Diagnostics and Troubleshooting	Explains how to interpret and correct problems that may occur while using the module.
8	Application Examples	Examines both basic and supplementary applications and gives examples of the ladder logic necessary to achieve the desired result.
Appendix A	Specifications	Provides physical, electrical, environmental, and functional specifications for the module.
Appendix B	Configuration Worksheet	Provides a worksheet to help you configure the module for operation.
Appendix C	Converting from 1746-NI4 to 1746-NI8	Describes how to reconfigure a system using 1746-NI4 modules to one with that uses 1746-NI8 modules.
Appendix D	Two's Complement Binary Numbers	Describes the two's complement binary number system.
	Glossary	Lists key terms and abbreviations.



## Related Documentation

The following documents contain information that may be helpful to you as you use Allen-Bradley SLC products. To obtain a copy of any of the Allen-Bradley documents listed, contact your local Allen-Bradley office or distributor.

For	Read This Document	Document Number
An overview of the SLC 500 family of products	SLC 500™ System Overview	1747-2.30
A description on how to install and use your <i>Modular</i> SLC 500 programmable controller	Installation & Operation Manual for Modular Hardware Style Programmable Controllers	1747-6.2
A description on how to install and use your <i>Fixed</i> SLC 500 programmable controller	Installation & Operation Manual for Fixed Hardware Style Programmable Controllers	1747-6.21
A procedural manual for technical personnel who use APS to develop control applications	Rockwell Software Advanced Programming Software (APS) User Manual	9399-APSUM
An introduction to APS for first-time users, containing basic concepts but focusing on simple tasks and exercises, and allowing the reader to quickly begin programming	APS Quick Start for New Users	9399-APSQS
A training and quick reference guide to APS	SLC 500™ Software Programmer's Quick Reference Guide Using APS – available on PASSPORT, list price \$50.00	ABT-1747-TSG001
A training and quick reference guide to A.I.	SLC 500™ Troubleshooting Guide Using A.I. Series – available on PASSPORT, list price \$50.00	ABT-1747-TSJ21
A common procedures guide to APS	SLC 500™ Family Common Procedures Guide Using APS – available on PASSPORT, list price \$50.00	ABT-1747-T550
A common procedures guide to A.I.	SLC 500™ Family Common Procedures Guide Using A.I. Series – available on PASSPORT, list price \$50.00	ABT-1747-TSJ51
A procedural and reference manual for technical personnel who use the APS import/export utility to convert APS files to ASCII and conversely ASCII to APS files	APS Import/Export User Manual	9399-APSie
A procedural and reference manual for technical personnel who use an HHT to develop control applications	Allen-Bradley Hand-Held Terminal User Manual	1747-NP002
An introduction to HHT for first-time users, containing basic concepts but focusing on simple tasks and exercises, and allowing the reader to quickly begin programming	Getting Started Guide for HHT	1747-NM009
A reference manual that contains status file data and instruction set information for the SLC 500 processors and MicroLogix 1000 controllers.	SLC 500™ / MicroLogix 1000™ Instruction Set Reference Manual	1747-6.15
In-depth information on grounding and wiring Allen-Bradley programmable controllers	Allen-Bradley Programmable Controller Grounding and Wiring Guidelines	1770-4.1
A description on how to install a PLC-5® system	PLC-5™ Family Programmable Controllers Hardware Installation Manual	1785-6.6.1
A description of important differences between solid-state programmable controller products and hard-wired electromechanical devices	Application Considerations for Solid-State Controls	SGL-1.1
An article on wire sizes and types for grounding electrical equipment	National Electrical Code	Published by the National Fire Protection Association of Boston, MA.
A complete listing of current Allen-Bradley documentation, including ordering instructions. Also indicates whether the documents are available on CD-ROM or in multi-languages.	Allen-Bradley Publication Index	SD499
A glossary of industrial automation terms and abbreviations	Allen-Bradley Industrial Automation Glossary	AG-7.1

## Common Techniques Used in this Manual

The following conventions are used throughout this manual:

- Bulleted lists such as this one provide information, not procedural steps.
- Numbered lists provide sequential steps or hierarchical information.
- Text in **this font** indicates words or phrases you should type.
- Key names appear in bold, capital letters within brackets (for example, [**ENTER**]).

## Allen-Bradley Support

Allen-Bradley offers support services worldwide, with over 75 Sales/Support Offices, 512 authorized Distributors and 260 authorized Systems Integrators located throughout the United States alone, plus Allen-Bradley representatives in every major country in the world.

### Local Product Support

Contact your local Allen-Bradley representative for:

- sales and order support
- product technical training
- warranty support
- support service agreements

### Technical Product Assistance

If you need to contact Allen-Bradley for technical assistance, please review the information in the *Troubleshooting* chapter first. Then call your local Allen-Bradley representative.

### Your Questions or Comments on this Manual

If you find a problem with this manual, please notify us of it on the enclosed Publication Problem Report.

If you have any suggestions for how this manual could be made more useful to you, please contact us at the address below:

Allen-Bradley  
Control and Information Group  
Technical Communication, Dept. A602V, T122  
P.O. Box 2086  
Milwaukee, WI 53201-2086

## Overview

This chapter describes the 1746-NI8 analog input module and explains how the SLC 500™ processor gathers analog input from the module. Included is information about:

- the module's hardware and diagnostic features
- an overview of system operation

## General Description

The module receives and stores digitally converted analog data into its image table for retrieval by all fixed and modular SLC 500 processors. The module supports connections from any combination of up to eight voltage or current analog sensors.

The 1746-NI8 is a multiclass (Class 1 or Class 3) single-slot module. Class 1<sup>①</sup> configuration utilizes 8 input words and 8 output words. Class 3 configuration utilizes 16 input words and 12 output words. Fixed and SLC 5/01™ processors can only operate as Class 1. The SLC 5/02™, SLC 5/03™, and SLC 5/04™ processors can be configured for either Class 1 or Class 3.

The 8 high-impedance input channels can be wired as either single-ended or differential inputs. The module provides a direct interface to the following input types:

- ±10V dc
- 1–5V dc
- 0–5V dc
- 0–10V dc
- 0–20 mA
- 4–20 mA
- ±20 mA
- 0–1 mA

The data presented to the processor can be configured as:

- Engineering Units
- Scaled-for-PID
- Proportional Counts (–32,768 to +32,767 range)
- Proportional Counts with User Defined Range (Class 3 only)
- 1746-NI4 Data Format

<sup>①</sup> Requires use of Block Transfer in a remote configuration.

Each input channel also provides open-circuit, out-of-range, and invalid configuration indication via the LEDs. In Class 3 operation these conditions are also in the channel status word.

**Important:** Status words are only available when the module is configured for Class 3.

### Hardware Features

The module fits into any slot, except the processor slot (0), in either an SLC 500 modular system or an SLC 500 fixed system expansion chassis (1746-A2).

The module contains a removable terminal block providing connection for eight analog input channels, which is specifically designed to interface with analog current and voltage input signals. The channels can be wired as either single-ended or differential inputs. There are no output channels on the module. Module configuration is done via the user program. There are DIP switches on the circuit board for selecting voltage or current input.

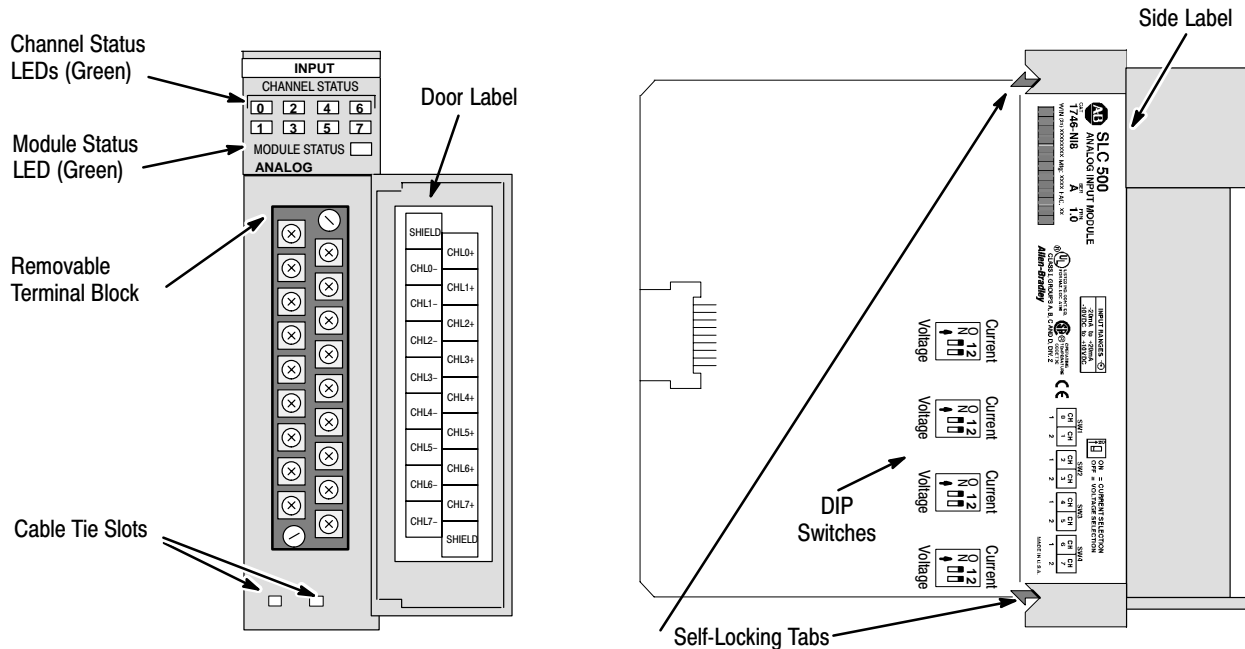

Hardware Feature	Function
Channel Status LED Indicators	Displays channel operating and fault status.
Module Status LED	Displays module operating and fault status.
Side Label (Nameplate)	Provides module information.
Removable Terminal Block	Provides physical connection to input devices.
Door Label	Permits easy terminal identification.
Cable Tie Slots	Secures and route wiring from module.
Self-Locking Tabs	Secures module in chassis slot.
Voltage/current Selection DIP Switches	Selects voltage or current input type to match the analog sensor.

## General Diagnostic Features

The 1746-NI8 module contains diagnostic features that can help you identify the source of problems that may occur during power-up or during normal channel operation. These power-up and channel diagnostics are explained in chapter 7, *Module Diagnostics and Troubleshooting*.

## System Overview

The module communicates to the SLC 500 processor through the parallel backplane interface and receives power from the SLC 500 power supply through the backplane. The +5V dc backplane supply powers the SLC circuitry, and the +24V dc backplane supply powers the module analog circuitry. No external power supply is required. You may install as many 1746-NI8 analog modules in your system as the power supply can support.

Each channel on the module can receive input signals from voltage or current analog input devices. You configure each channel individually to accept either a voltage or current input signal.

## System Operation

At power-up, the module performs a check of its internal circuits, memory, and basic functions. During this time the module status LED remains off. If no faults are found during the power-up diagnostics, the module status LED is turned on.

After power-up checks are complete, the module waits for valid channel configuration data from your SLC ladder logic program (channel status LEDs off). After configuration data is written to one or more channel configuration words and the channel enable status bits are set, the channel status LEDs go on and the module continuously converts the analog input to a value within the range you selected.

Each time a channel is read by the module, that data value is tested by the module for a fault condition (i.e., open-circuit, over-range, and under-range). If such a condition is detected, a unique bit is set in the channel status word and the channel status LED blinks.

The SLC processor reads the converted analog data from the module at the end of the program scan, or when commanded by the ladder program. The processor and module determine that the backplane data transfer was made without error, and the data is used in your ladder program. A graphic representation of this is shown below.

#### Data Transfer Between the Module and Processor (shown for one channel)

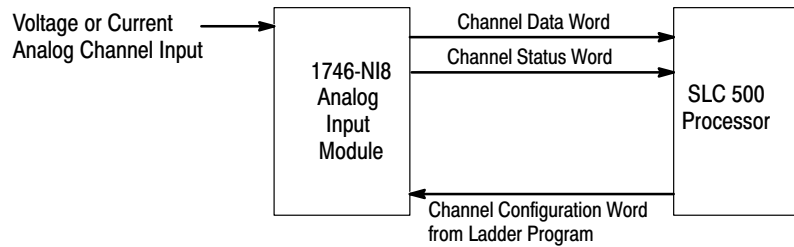

### Module Operation

The 1746-NI8 module's input circuitry consists of eight differential analog inputs multiplexed into a single analog-to-digital (A/D) converter.

The A/D converter reads the selected input signal and converts it to a digital value. The multiplexer sequentially switches each input channel to the module's A/D converter. Multiplexing provides an economical means for a single A/D converter to convert multiple analog signals. However, multiplexing also affects the speed at which an input signal can change and still be detected by the converter.

### Module Calibration

The module performs continuous autocalibration for all the channels that are enabled. There is no need to invoke a calibration cycle to compensate for changes in temperature.

## Quick Start for Experienced Users

This chapter can help you to get started using the 1746-NI8 analog input module. We base the procedures here on the assumption that you have an understanding of SLC 500 products. You should understand electronic process control and be able to interpret the ladder logic instructions required to generate the electronic signals that control your application.

Because it is a start-up guide for experienced users, this chapter *does not* contain detailed explanations about the procedures listed. It does, however, reference other chapters in this book where you can get more information about applying the procedures described in each step. It also references other documentation that may be helpful if you are unfamiliar with programming techniques or system installation requirements.

If you have any questions or are unfamiliar with the terms used or concepts presented in the procedural steps, *always read the referenced chapters* and other recommended documentation before trying to apply the information.

This chapter will:

- tell you what equipment you need
- explain how to install and wire the module
- show you how to set up one channel for analog input
- examine the state of the LEDs at normal startup
- examine the channel status word

### Required Tools and Equipment

Have the following tools and equipment ready:

- medium blade screwdriver
- medium cross-head screwdriver
- analog input device
- cable for wiring inputs to module
- SLC processor and power supply installed in chassis
- analog input module (1746-NI8)
- programming device and software

## Procedures

<b>1.</b>	<b>Check the contents of shipping box.</b>	<b>Reference</b>
<p>Unpack the shipping box making sure that the contents include:</p> <ul style="list-style-type: none"> <li>• analog input module (Catalog Number 1746-NI8)</li> <li>• removable terminal block (factory-installed)</li> </ul> <p>If the contents are incomplete, call your local Allen-Bradley representative for assistance.</p>		-
<b>2.</b>	<b>Ensure that your chassis and power supply support the 1746-NI8 module.</b>	<b>Reference</b>
<p>Review the power requirements of your system to see that your chassis supports the module:</p> <ul style="list-style-type: none"> <li>• If combining a 1746-NI8 module with another I/O module in a fixed controller, refer to the I/O module compatibility table found in chapter 3.</li> <li>• For modular style systems, calculate the total load on the system power supply using the procedure described in the <i>SLC Installation &amp; Operation Manual for Modular Style Controllers</i> (publication 1747-6.2) or the <i>SLC 500 Family System Overview</i> (publication 1747-2.30).</li> <li>• The 1746-NI8 backplane current consumption is 200 mA at 5V dc and 100 mA at 24V dc.</li> </ul>		<p><b>Chapter 3</b> <i>(Installation and Wiring)</i></p> <p><b>Appendix A</b> <i>(Specifications)</i></p>
<b>3.</b>	<b>Select voltage or current input type to match the analog sensor.</b>	<b>Reference</b>

The voltage/current selection DIP switches are located on the side of the module. The switch settings are OFF = VOLTAGE INPUT and ON = CURRENT INPUT.

**Chapter 3**  
*(Installation and Wiring)*

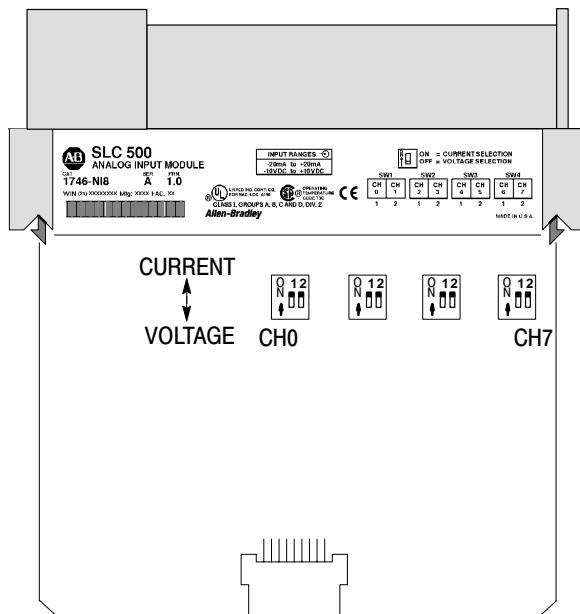



**4. Insert the 1746-NI8 module into the chassis.****Reference**

**ATTENTION:** Never install, remove, or wire modules with power applied to the chassis or devices wired to the module.

Make sure system power is off; then insert the module into your 1746 chassis.

In this example procedure, local slot 1 is selected.

**Important:** For applications using the upper limit of the operating temperature range, the 1746-NI8 module (or multiple 1746-NI8 modules) should be placed in the right most slot(s) of the chassis. The specification for operating temperature is:

0°C to 55°C (32°F to 131°F) in any slot except slot 0

0°C to 60°C (32°F to 140°F) in right most slot of chassis

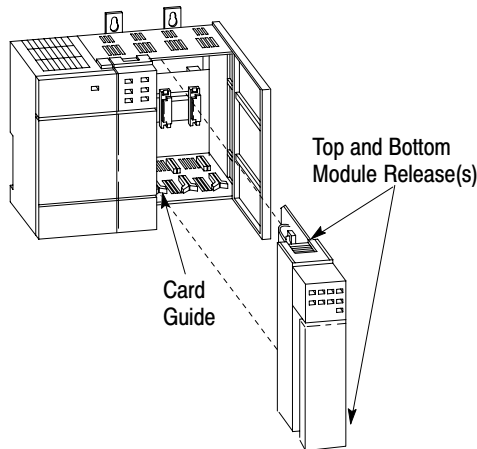

**Chapter 3**  
(Installation and  
Wiring)

**5. Connect sensor cable.****Reference**

Connect sensor cable to the module's terminal block.

**Important:** Follow these guidelines when wiring the module.

- Use shielded communication cable (Belden 8761) and keep length as short as possible.
- Connect only one end of the cable shield to earth ground.
- Connect the shield drain wires for channels 0-3 to the top shield terminal.
- Connect the shield drain wires for channels 4-7 to the bottom shield terminal.
- Shield terminals are internally connected to chassis ground which is connected to earth ground via the SLC backplane.
- Single-ended source commons may be jumpered together at the terminal block.
- Channels are not isolated from each other. All analog commons are connected together internally.
- If a differential signal source has an analog common, it can not and must not be connected to the module.
- Common mode voltage range is  $\pm 10.5$  volts. The voltage between any two terminals must be less than 21 volts.
- The module does not provide power for the analog inputs.
- Use a power supply that matches the transmitter (sensor) specifications.

**Chapter 3**  
(Installation and  
Wiring)

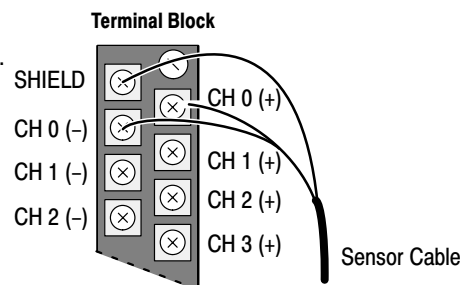

<b>6. Configure the system.</b>	<b>Reference</b>
---------------------------------	------------------

Configure your system I/O for the particular slot the 1746-NI8 is in (slot 1 in this example). Enter the module ID code. The ID code is 3526 for Class 1 interface, and 12726 for Class 3 interface. See chapter 4 for more information on Class 1 and Class 3 interfaces.

**Chapter 4**  
*(Preliminary Operating Considerations)*

**Important:** All programming software does not support configuration for Class 3 operation.

- Advanced Programming Software (APS) supports Class 3 configuration. After entering the ID code (12726), enter 16 input words and 12 output words.
- SLC 500 A.I. Series™ Programming Software supports Class 3 configuration. After entering the ID code (12726), enter 16 input words and 12 output words.
- RSLogix 500™, version 1.30 or later, supports Class 3 configuration. After entering the ID code (12726), select Class 3 operation.
- Earlier versions of RSLogix 500 will only support configuration for Class 1 operation. Contact Rockwell Software for information on upgrading your software.

**Appendix C**  
*(Converting from 1746-NI4 to 1746-NI8)*

Your programming device's user manual.

If you are converting from a 1746-NI4 to a 1746-NI8 based system, see Appendix C.

<b>7. Determine the operating parameters.</b>	<b>Reference</b>
-----------------------------------------------	------------------

Determine the operating parameters for channel 0. This example shows the channel 0 configuration word. The module is in slot 1. The default configuration word is all zero's.

**Chapter 4**  
*(Preliminary Operating Considerations)*

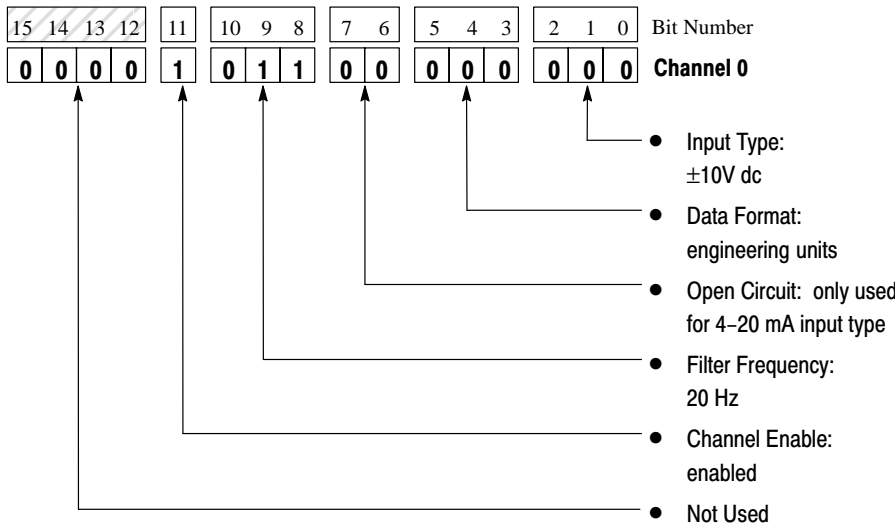

**Chapter 5**  
*(Channel Configuration, Data, and Status)*

**Appendix B**  
*(NI8 Configuration Worksheet)*

**Appendix C**  
*(Converting from 1746-NI4 to 1746-NI8)*

1746-NI8 Module Output Image - Channel Configuration			Class 1	Class 3
O:1.0	channel 0 configuration word	bit mapped field	•	•
O:1.1	channel 1 configuration word	bit mapped field	•	•
O:1.2	channel 2 configuration word	bit mapped field	•	•
O:1.3	channel 3 configuration word	bit mapped field	•	•
O:1.4	channel 4 configuration word	bit mapped field	•	•
O:1.5	channel 5 configuration word	bit mapped field	•	•
O:1.6	channel 6 configuration word	bit mapped field	•	•
O:1.7	channel 7 configuration word	bit mapped field	•	•
O:1.8	lower scale limit range 0	16 bit integer		•
O:1.9	upper scale limit range 0	16 bit integer		•
O:1.10	lower scale limit range 1	16 bit integer		•
O:1.11	upper scale limit range 1	16 bit integer		•

<b>8.</b>	<b>Program the configuration.</b>	<b>Reference</b>
-----------	-----------------------------------	------------------

Do the programming necessary to establish the new configuration word setting in the previous step.

1. Create integer file N10. Integer file N10 should contain one element for each channel used.  
(For this example we only need one, N10:0.)
2. Enter the configuration parameters from step 7 for channel 0 into integer N10:0.
3. Program an instruction in your ladder logic to copy the contents of N10:0 to output word O:1.0.

**Chapter 6**  
*(Ladder Logic Configuration Examples)*

**Chapter 8**  
*(Application Examples)*

**DATA FILE N10**

Offset	15	14	13	12	11	10	9	8	7	6	5	4	3	2	1	0
N10:0	0	0	0	0	1	0	1	1	0	0	0	0	0	0	0	0



On power up, the first pass bit (S:1/15) is set for one scan, enabling the COPY instruction that transfers the channel configuration word 0. This configures and enables the channel.

<b>9.</b>	<b>Write the ladder program.</b>	<b>Reference</b>
-----------	----------------------------------	------------------

Write the remainder of the ladder logic program that specifies how your analog input data will be processed for your application. In this procedure the module is located in slot 1.

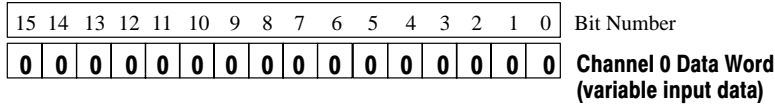

**Chapter 5**  
*(Channel Configuration, Data, and Status)*

**Chapter 6**  
*(Ladder Logic Configuration Examples)*

**Chapter 8**  
*(Application Examples)*

Your programming device's user manual.

1746-NI8 Module Input Image - Data Word			Class 1	Class 3
I:1.0	channel 0 data word	16 bit integer	•	•
I:1.1	channel 1 data word	16 bit integer	•	•
I:1.2	channel 2 data word	16 bit integer	•	•
I:1.3	channel 3 data word	16 bit integer	•	•
I:1.4	channel 4 data word	16 bit integer	•	•
I:1.5	channel 5 data word	16 bit integer	•	•
I:1.6	channel 6 data word	16 bit integer	•	•
I:1.7	channel 7 data word	16 bit integer	•	•

<b>10.</b>	<b>Go through the system start-up procedure.</b>	<b>Reference</b>
------------	--------------------------------------------------	------------------

Apply power. Download your program to the SLC processor and put the controller into Run mode. During a normal start up, the module status LED and any enabled channel status LED turn on.

**Chapter 7**  
*(Module Diagnostics and Troubleshooting)*

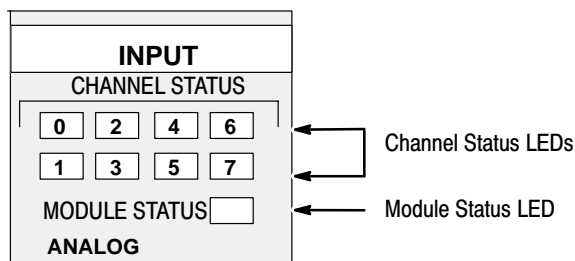

<b>11. Check that the module is operating correctly.</b>	<b>Reference</b>
----------------------------------------------------------	------------------

(Optional) If the Module Status LED is off, or if the Channel 0 LED is off or blinking, refer to chapter 7.

Class 3 Interface – Monitor the status of input channel 0 to determine its configuration setting and operational status. This is useful for troubleshooting when the blinking channel LED indicates that an error has occurred. The example below shows the configuration for channel 0 with no errors.

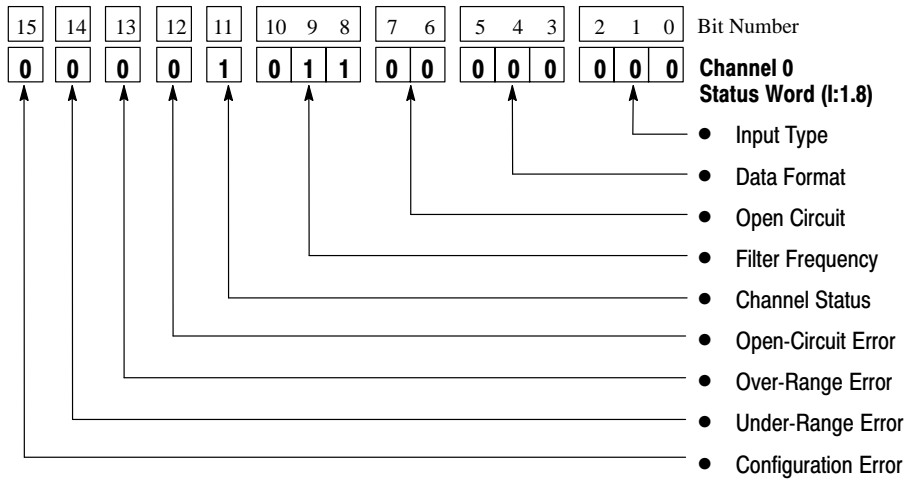

**Chapter 5**  
*(Channel Configuration, Data, and Status)*

**Chapter 7**  
*(Module Diagnostics and Troubleshooting)*

**Chapter 8**  
*(Application Examples)*

## Installation and Wiring

This chapter tells you how to:

- avoid electrostatic damage
- determine the chassis power requirement for the module
- choose a location for the module in the SLC chassis
- set the channels for voltage or current analog input
- install the module
- wire the module's terminal block
- wire input devices

### Electrostatic Damage

Electrostatic discharge can damage semiconductor devices inside this module if you touch backplane connector pins. Guard against electrostatic damage by observing the following precautions.



**ATTENTION:** Electrostatic discharge can degrade performance or cause permanent damage. Handle the module as stated below.

- Wear an approved wrist strap grounding device when handling the module.
- Touch a grounded object to rid yourself of electrostatic charge before handling the module.
- Handle the module from the front, away from the backplane connector. Do not touch backplane connector pins.
- Keep the module in its static-shield bag when not in use, or during shipment.

### 1746-NI8 Power Requirements

The 1746-NI8 module receives its power through the SLC 500 chassis backplane from the fixed or modular +5V dc/+24V dc chassis power supply. The +5V dc backplane supply powers the SLC circuitry, and the +24V dc backplane supply powers the module analog circuitry. The maximum current drawn by the module is shown in the table below.

5V dc Amps	24V dc Amps
0.200	0.100

When you are using a *modular system* configuration, add the values shown in the table above to the requirements of all other modules in the SLC chassis to prevent overloading the chassis power supply.

When using a *fixed system* controller, refer to the **Important** note about compatibility in a 2-slot expansion chassis on page 3–2.

## Module Location in Chassis

Fixed Controller Compatibility Table

	NI8	5V dc (Amps)	24V dc (Amps)
IA4	•	0.035	-
IA8	•	0.050	-
IA16	•	0.085	-
IM4	•	0.035	-
IM8	•	0.050	-
IM16	•	0.085	-
OA8		0.185	-
OAP12		0.370	-
OA16		0.370	-
IB8	•	0.050	-
IB16	•	0.085	-
IC16	•	0.085	-
ITB16	•	0.085	-
ITV16	•	0.085	-
IV8	•	0.050	-
IV16	•	0.085	-
IG16	•	0.140	-
OV8	•	0.135	-
OV16		0.270	-
OB8	•	0.135	-
OBP8	•	0.135	-
OBP16		0.250	-
OVP16		0.250	-
OG16		0.180	-
OW4	•	0.045	0.045
OW8		0.085	0.090
OW16		0.170	0.180
IO4	•	0.030	0.025
IO8	•	0.060	0.045
IO12		0.090	0.070
NI4		0.025	0.085
NI8		0.200	0.100
NIO4I		0.055	0.145
FIO4I		0.055	0.150
FIO4V		0.055	0.120
NIO4V		0.055	0.115
NT4	•	0.060	0.040
NR4	•	0.050	0.050
HSTP1		0.200	-
IH16	•	0.085	-
DCM		0.360	-
HS		0.300	-
OB16		0.280	-
IN16	•	0.085	-
<b>BASn</b>		0.150	0.125
BAS		0.150	0.040
OB32		0.452	-
OV32		0.452	-
IV32		0.106	-
IB32		0.106	-
OX8		0.085	0.090
NO4I	▽	0.055	0.195
NO4V	▽	0.055	0.145
<b>KE<sub>n</sub></b>		0.150	0.125
KE		0.150	0.040

## Modular Chassis Considerations

Place your 1746-NI8 module in any slot of an SLC 500 modular, or modular expansion chassis, except for the extreme left slot (slot 0) in the first chassis. This slot is reserved for the processor or adapter modules.

**Important:** For applications using the upper limit of the operating temperature range, the 1746-NI8 module (or multiple 1746-NI8 modules) should be placed in the right most slot(s) of the chassis. The specification for operating temperature is:

---

### Operating Temperature Range

---

0°C to 55°C (32°F to 131°F) in any slot except slot 0

0°C to 60°C (32°F to 140°F) in right most slot of chassis

---

## Fixed Expansion Chassis Considerations

**Important:** The 2-slot, SLC 500 fixed I/O expansion chassis (1746-A2) will support only specific combinations of modules. If you are using the 1746-NI8 module in a 2-slot expansion chassis with another SLC I/O or communication module, refer to the table at the left to determine whether the combination can be supported. In the table:

- A dot indicates a valid combination.
- No symbol indicates an invalid combination.
- A triangle indicates an external power supply is required. (Refer to the Analog I/O Module User Manual, publication 1746-6.4.)

When using the table, be aware that there are certain conditions that affect the compatibility characteristics of the BASIC module (**BAS**) and the DH-485/RS-232C module (**KE**).

When you use the BAS module or the KE module to supply power to a 1747-AIC Link Coupler, the Link Coupler draws its power through the module. The higher current drawn by the AIC at 24V dc is calculated and recorded in the table for the modules identified as **BASn** (BAS networked) or **KE<sub>n</sub>** (KE networked). Make sure to refer to these modules if your application uses the BAS or KE module in this way.

## General Considerations

Most applications require installation in an industrial enclosure to reduce the effects of electrical interference. Analog inputs are highly susceptible to electrical noise. Electrical noise coupled to the analog inputs will reduce the performance (accuracy) of the module.

Group your modules to minimize adverse effects from radiated electrical noise and heat. Consider the following conditions when selecting a slot for the analog input module. Position the module:

- in a slot away from sources of electrical noise such as hard-contact switches, relays, and AC motor drives
- away from modules which generate significant radiated heat, such as the 32-point I/O modules

In addition, route shielded twisted pair analog input wiring away from any high voltage I/O wiring.

## Compliance to European Union Directives

This product is approved for installation within the European Union and EEA regions. It has been designed and tested to meet the following directives.

### EMC Directive

The 1746-NI8 analog input module is tested to meet Council Directive 89/336/EEC Electromagnetic Compatibility (EMC) and the following standards, in whole or in part, documented in a technical construction file:

- EN 50081-2  
EMC – Generic Emission Standard, Part 2 – Industrial Environment
- EN 50082-2  
EMC – Generic Immunity Standard, Part 2 – Industrial Environment

This product is intended for use in an industrial environment.



## Module Installation and Removal

When installing the module in a chassis, it is not necessary to remove the terminal block from the module. However, if the terminal block is removed, use the write-on label located on the side of the terminal block to identify the module location and type.

### Terminal Block Removal

SLOT _____	RACK _____
● MODULE _____	



**ATTENTION:** Never install, remove, or wire modules with power applied to the chassis or devices wired to the module.

To remove the terminal block:

1. Loosen the two terminal block release screws.
2. Grasp the terminal block at the top and bottom and pull outward and down.

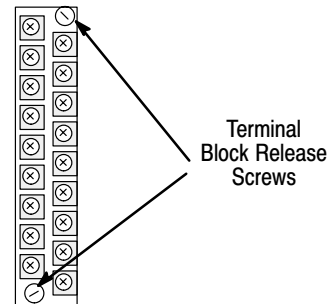

### Switch Settings to Select Voltage or Current Input

Select between voltage and current inputs before installing the module in the chassis. Use the DIP switches on the module circuit board. The switch settings are OFF = VOLTAGE INPUT and ON = CURRENT INPUT. Do this for channels 0-7.

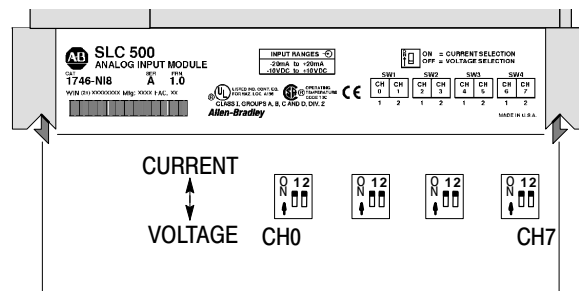

## Module Installation Procedure

1. Align the circuit board of the analog input module with the card guides located at the top and bottom of the chassis.
2. Slide the module into the chassis until both top and bottom retaining clips are secured. Apply firm even pressure on the module to attach it to its backplane connector. Never force the module into the slot.
3. Cover all unused slots with the Card Slot Filler, Catalog Number 1746-N2.

**Important:** For applications using the upper limit of the operating temperature range, the 1746-NI8 module (or multiple 1746-NI8 modules) should be placed in the right most slot(s) of the chassis. The specification for operating temperature is:

---

**Operating Temperature Range**

---

0°C to 55°C (32°F to 131°F) in any slot except slot 0

0°C to 60°C (32°F to 140°F) in right most slot of chassis

---

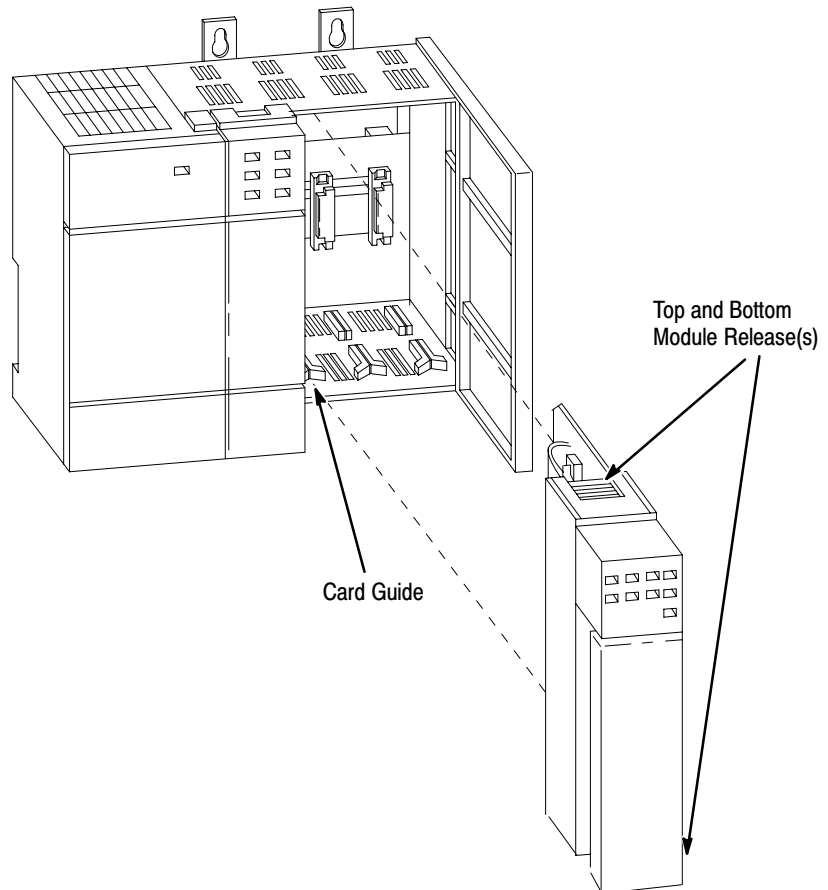

## Module Removal Procedure

1. Press the releases at the top and bottom of the module and slide the module out of the chassis slot.
2. Cover all unused slots with the Card Slot Filler, Catalog Number 1746-N2.

## Terminal Wiring

The 1746-NI8 module contains an 18-position, removable terminal block. The terminal pin-out is shown below.



**ATTENTION:** Disconnect power to the SLC before attempting to install, remove, or wire the removable terminal wiring block.

To avoid cracking the removable terminal block, alternate the removal of the slotted terminal block release screws.

## Terminal Block

(Terminal Block Spare Part Catalog Number 1746-RT25G)

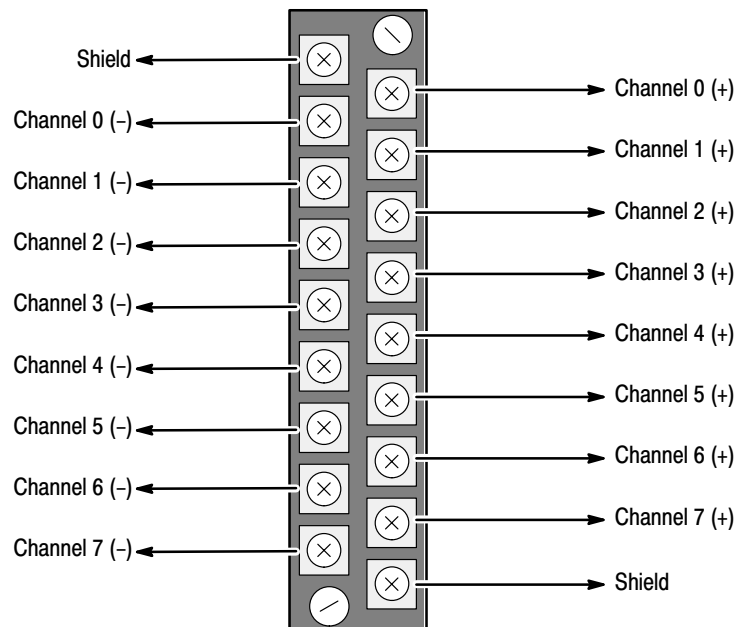

## Wiring Single-Ended and Differential Inputs

The diagram below shows typical wiring for the module.

**Important:** Follow these guidelines when wiring the module.

- Use shielded communication cable (Belden 8761) and keep length as short as possible.
- Connect only one end of the cable shield to earth ground.
- Connect the shield drain wires for channels 0-3 to the top shield terminal.
- Connect the shield drain wires for channels 4-7 to the bottom shield terminal.
- Shield terminals are internally connected to chassis ground which is connected to earth ground via the SLC backplane.
- Single-ended source commons may be jumpered together at the terminal block.
- Channels are not isolated from each other.
- If a differential signal source has an analog common, it can not and must not be connected to the module.
- Common mode voltage range is  $\pm 10.5$  volts. The voltage between any two terminals must be less than 21 volts.
- The module does not provide power for the analog inputs.
- Use a power supply that matches the transmitter (sensor) specifications.

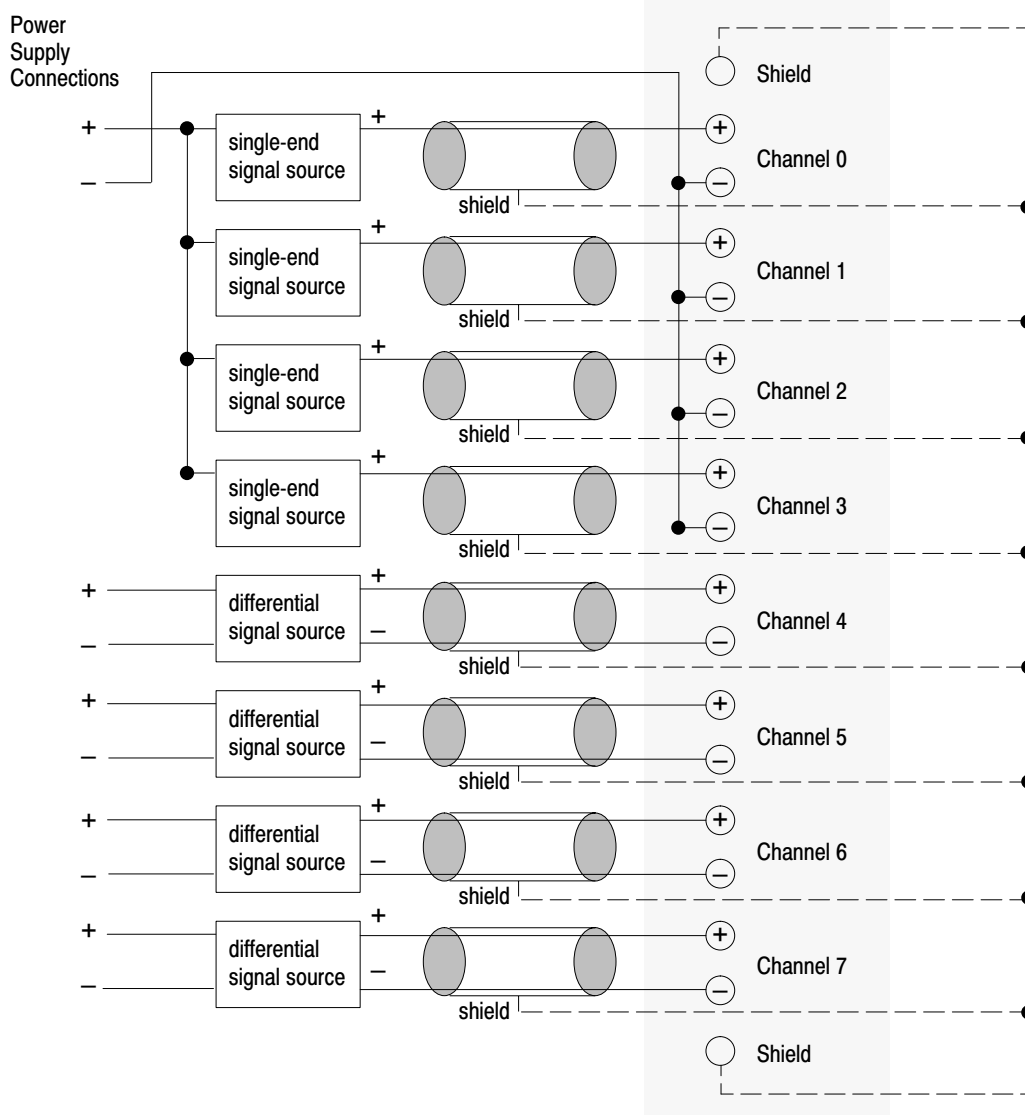

**Wiring Schematic for Single-ended Analog Input Connections**

When wiring single-ended analog input devices to the analog input module, the number of total wires necessary can be limited by jumpering all "IN-" terminals together. Note that differential inputs are more immune to noise than single-ended inputs.

**Important:** The module does *not* provide loop power for analog inputs. Use a power supply that matches the transmitter specifications.

**Important:** Follow the guidelines on pages 3-7 and 3-9 when wiring the module.

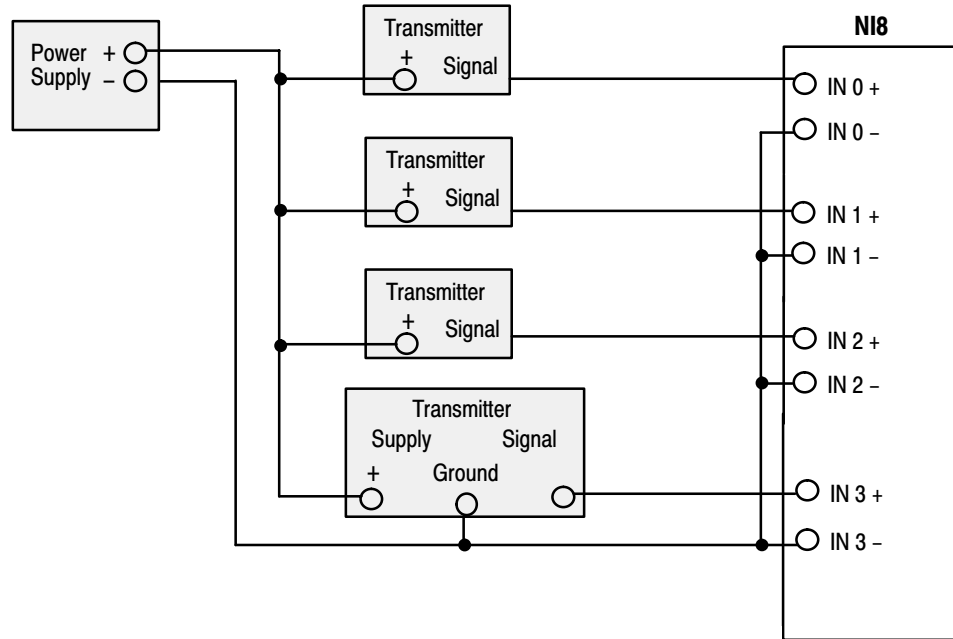

**Wiring Schematics for 2, 3, and 4-Wire Analog Input Devices**

**Important:** The module does *not* provide loop power for analog inputs. Use a power supply that matches the transmitter specifications.

**Important:** Follow the guidelines on pages 3-7 and 3-9 when wiring the module.

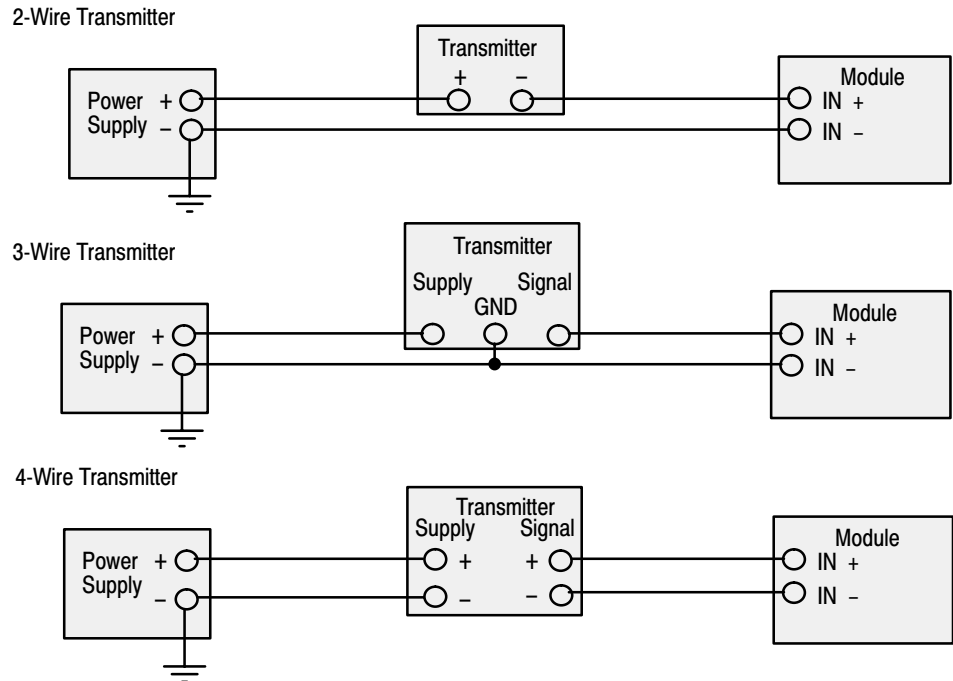

## Wiring Guidelines



**ATTENTION:** To prevent shock hazard, care should be taken when wiring the module to analog signal sources. Before wiring any analog module, disconnect power from the SLC 500 system and from any other source to the analog module.

Follow the guidelines below when planning your system wiring.

- To limit noise, keep signal wires as far away as possible from power and load lines.
- To ensure proper operation and high immunity to electrical noise, always use Belden 8761 (shielded, twisted pair) or equivalent wire.
- Connect the shield drain wire to the shield terminal on the 1746-NI8 module. Up to four shield wires may be connected to each shield connection screw terminal that provides a connection to chassis ground.
- Tighten terminal screws using a flat or cross-head screwdriver. Each screw should be turned tight enough to immobilize the wire's end. Excessive tightening can strip the terminal screw. The torque applied to each screw should not exceed 5 lb-in (0.565 Nm) for each terminal.
- Follow system grounding and wiring guidelines found in your SLC 500 Modular Hardware Style Installation and Operation Manual, publication 1747-6.2.

## Input Devices

### Transducer Source Impedance

If the source impedance of the input device and associated cabling is too high, it will affect the accuracy of the channel data word. Source impedance of 500 ohms will produce up to 0.05% of module error over and above the specified accuracy of the module.

You can compensate for device impedance error by implementing the following equation in your ladder program:

$$V_s = V_{measured} \times \left[ \frac{(R_s + R_{in})}{R_{in}} \right]$$

where:

- $V_s$  = input device voltage
- $R_s$  = input device source impedance
- $R_{in}$  = 1746-NI8 input impedance (1 M $\Omega$ )

### Wiring Input Devices to the 1746-NI8

After the analog input module is properly installed in the chassis, follow the wiring procedure below using Belden 8761 cable.



**ATTENTION:** Care should be taken to avoid connecting a voltage source to a channel configured for current input. Improper module operation or damage to the voltage source can occur.

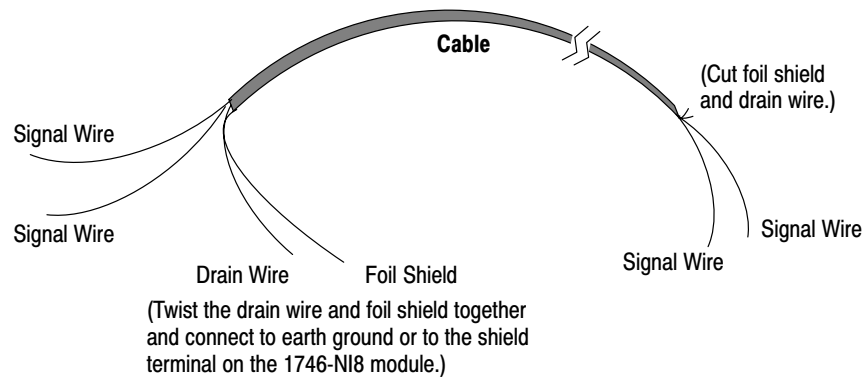

To wire your 1746-NI8 module follow these steps.

1. At each end of the cable, strip some casing to expose the individual wires.
2. Trim the signal wires to 2-inch lengths. Strip about 3/16 inch (5 mm) of insulation away to expose the end of the wire.
3. At one end of the cable, twist the drain wire and foil shield together. This end of the cable will be connected to one of the shield terminals on 1746-NI8 module. Connect shields for channels 0-3 to the upper shield terminal, and shields for channels 4-7 to the lower shield terminal.
4. At the other end of the cable, cut the drain wire and foil shield back to the cable.
5. Connect the signal wires and the shield drain wire to the 1746-NI8 terminal block. Connect the other end of the cable to the input device.
6. Repeat steps 1 through 6 for each channel on the module.

## Preliminary Operating Considerations

This chapter explains how the analog input module and the SLC 500 processor communicate through the module's input and output image. It lists the preliminary setup and operation required before the module can function in a 1746 I/O system. Topics discussed include how to:

- enter the module ID code
- select the Class 1 or Class 3 interface
- address your 1746-NI8 module
- select the proper input filter for each channel
- calculate the module update time
- interpret the module response to slot disabling

### Module ID Code

The module identification code is a unique number encoded for each 1746 I/O module. The code defines for the processor the type of I/O or specialty module residing in a specific slot in the 1746 chassis.

Catalog Number	ID Code
1746-NI8	3526 - Class 1 interface 12726 - Class 3 interface

**Important:** All programming software does not support configuration for Class 3 operation.

- Advanced Programming Software (APS) supports Class 3 configuration. After entering the ID code (12726), enter 16 input words and 12 output words.
- SLC 500 A.I. Series™ Programming Software supports Class 3 configuration. After entering the ID code (12726), enter 16 input words and 12 output words.
- RSLogix 500™, version 1.30 or later, supports Class 3 configuration. After entering the ID code (12726), select Class 3 operation.
- Earlier versions of RSLogix 500 will only support configuration for Class 1 operation. Contact Rockwell Software for information on upgrading your software.



## Class 1 and Class 3 Interface

The 1746-NI8 analog input module has multiclass interface capabilities. Class 1 is the standard configuration. The module can be configured through the user program for Class 3 which enables user-defined data scaling and monitoring of channel status words.

Configuration	Class 1	Class 3
<b>Compatible SLC Processors</b>	SLC 500 fixed, SLC 5/01, SLC 5/02, SLC 5/03, and SLC 5/04	SLC 5/02, SLC 5/03, and SLC 5/04
<b>Compatible Chassis</b>	local chassis or remote chassis with a 1747-ASB module	local chassis
<b>Input and Output Images</b>	<b>output image:</b> 8 channel configuration words <b>input image:</b> 8 channel data words	<b>output image:</b> 8 channel configuration words and 4 limit ranges for user-defined scaling data format <b>input image:</b> 8 channel data words and 8 channel status words
<b>Default</b>	Class 1 is the default on power-up	Class 3 is programmable by user

## Module Addressing

The following memory maps show you how the input and output input image tables are defined for Class 1 and Class 3.

### Class 1 Memory Map

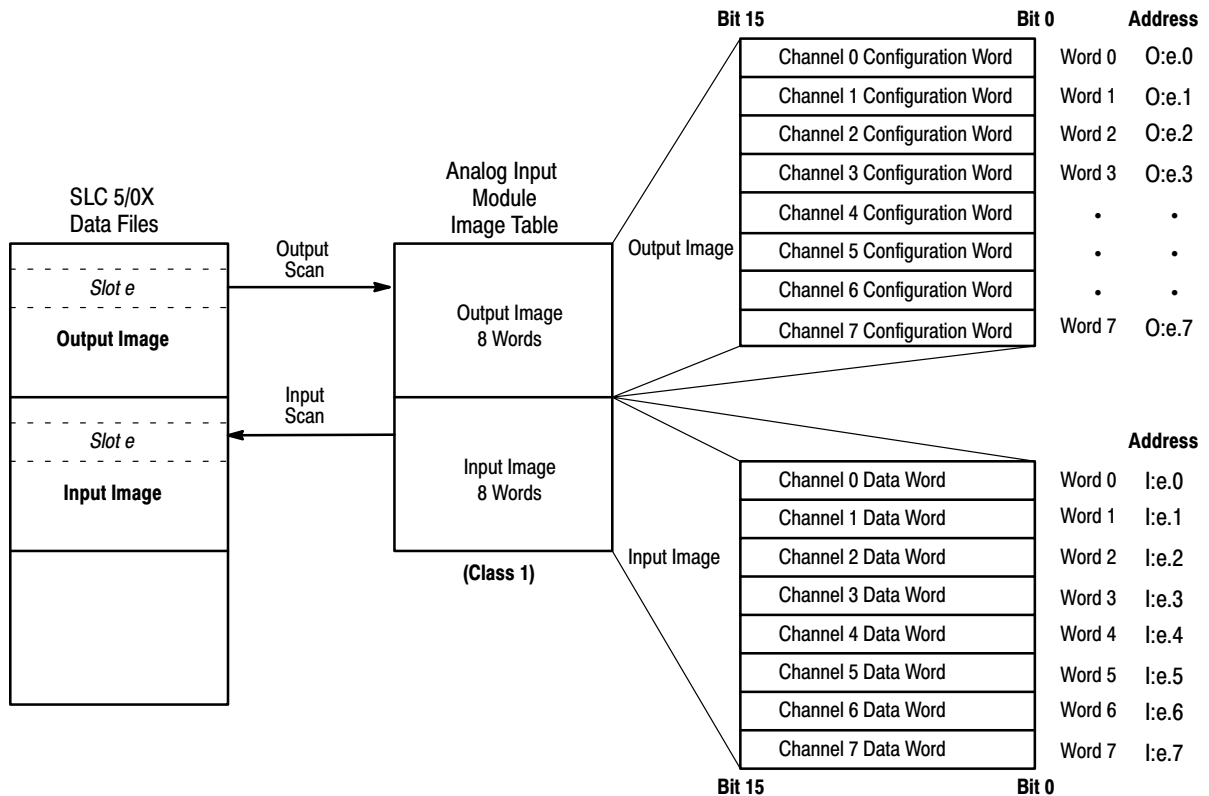

### Class 3 Memory Map

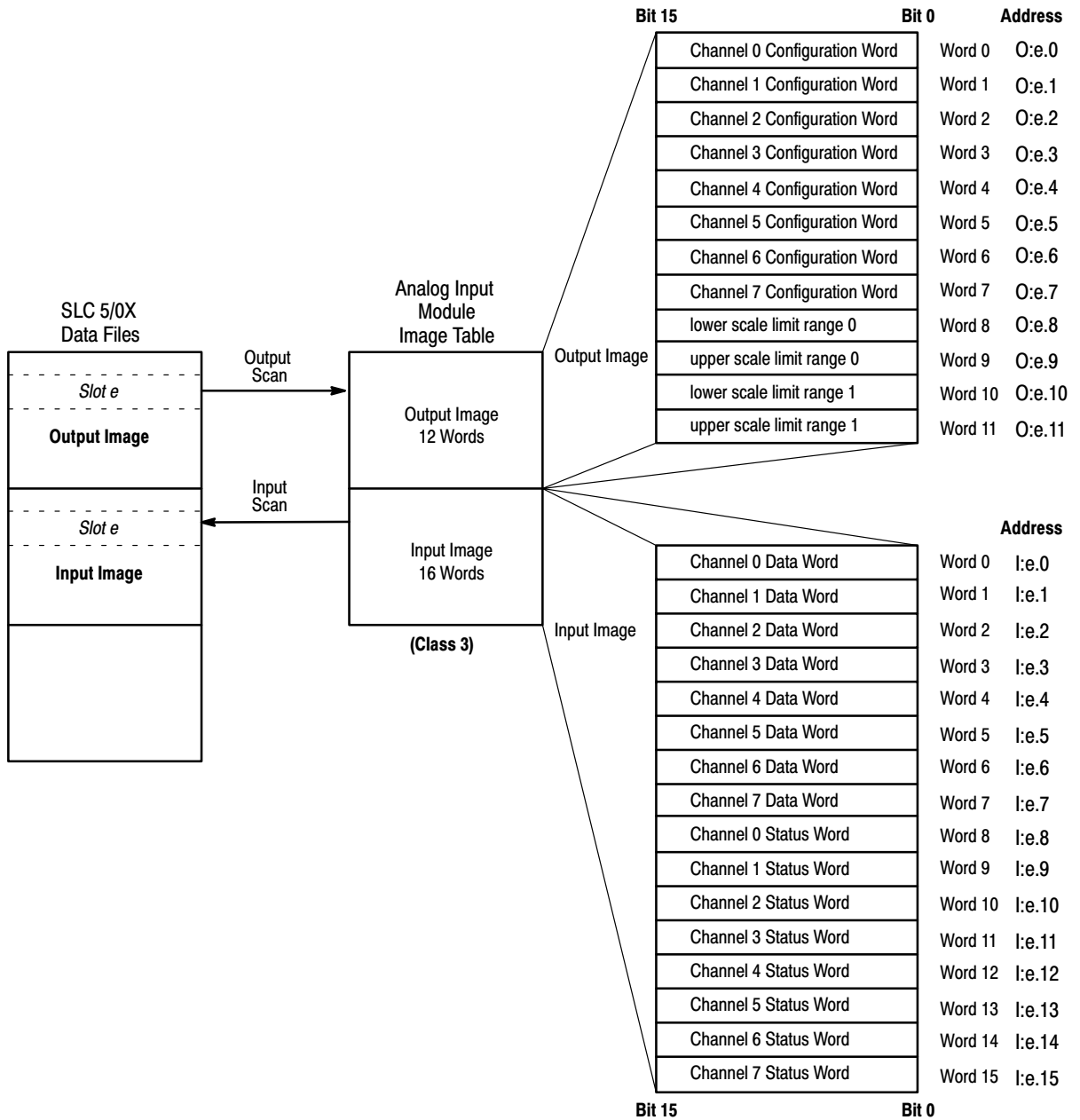

### Output Image - Configuration Words

The module output image (defined as the output from the processor to the module) contains information that you configure to define the way a specific module channel will work. Each output word configures a single channel.

**Example** – If you want to configure channel 2 on the analog module located in slot 4 in the chassis, your address would be O:4.2.

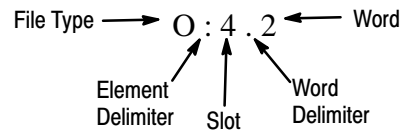

Chapter 5, *Channel Configuration, Data, and Status*, gives you detailed bit information about the data content of the configuration word.

### Input Image – Data Words and Status Words

The input image (defined as the input from the module to the processor) represents data words and status words.

**Important:** Status words are only available when the module is configured for Class 3.

Input words 0–7 (data words) hold the input data that represent the value of analog inputs for channels 0–7. This data word is valid only when the channel is enabled and there are no channel errors.

Input words 8–15 (status words) contain the status of channels 0–7 respectively. The status bits for a particular channel reflect the configuration settings that you entered into the output image configuration word for that channel and provide information about the channel’s operational state. To receive valid status information the channel must be enabled, and the channel must have processed any configuration changes that may have been made to the configuration word.

**Example** – To obtain the status of channel 2 (input word 10) of the analog module located in slot 4 in the SLC chassis, use address I:4.10.

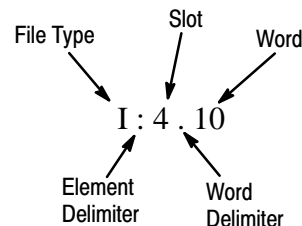

Chapter 5, *Channel Configuration, Data, and Status*, gives you detailed bit information about the content of the data word and the status word.

## Module Update Time

The module update time is defined as the time required for the module to sample and convert the input signals of all enabled input channels and provide the resulting data values to the SLC processor. Module update time can be calculated by adding the the sum of all enabled channel sample times (0.75 msec per channel).

The 1746-NI8 module sequentially samples the channels in a continuous loop.

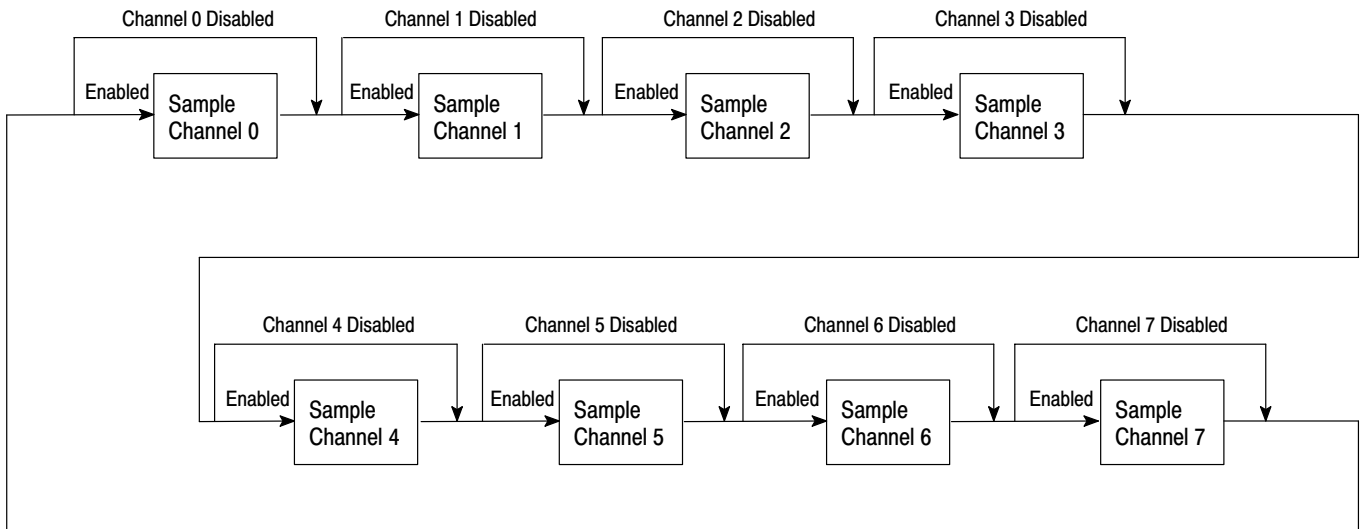

The following table shows the module update time. The module update time is the same regardless of the filter frequency. The fastest module update time occurs when only one channel is enabled. The slowest module update time occurs when 8 channels are enabled.

Module Update Time	
Number of Channels Enabled	Update Time
1	0.75 msec
2	1.50 msec
3	2.25 msec
4	3.00 msec
5	3.75 msec
6	4.50 msec
7	5.25 msec
8	6.00 msec

## Channel Turn-On, Turn-Off, and Reconfiguration Times

The table below gives you the turn-on, turn-off, and reconfiguration times for enabling or disabling a channel.

	Description	Duration <sup>①</sup>
<b>Turn-On Time</b>	The time it takes to set the status bit (transition from 0 to 1) in the status word, after setting the enable bit in the configuration word.	101 to 107 msec maximum
<b>Turn-Off Time</b>	The time it takes to reset the status bit (transition from 1 to 0) in the status word, after resetting the enable bit in the configuration word.	1 to 7 msec maximum
<b>Reconfiguration Time</b>	The time it takes to change a channel configuration if the device type, filter frequency, or configuration error bits are different from the current setting. The enable bit remains in a steady state of 1. Changing data format does not require reconfiguration time.	101 to 107 msec maximum

<sup>①</sup> The duration varies with the number of channels that are enabled.

## Response to Slot Disabling

By writing to the status file in your modular SLC processor you can disable any chassis slot. Refer to your programming device's manual for the slot disable/enable procedure.



**ATTENTION:** Always understand the implications of disabling a module before using the slot disable feature.

## Input Response

When a slot is disabled, the 1746-NI8 module continues to update its input image table. However, the SLC processor does not read inputs from a module that is disabled. Therefore, when the processor disables the module slot, the module inputs appearing in the processor image table remain in their last state, and the module's updated image table is not read. When the processor re-enables the module slot, the current state of the module inputs are read by the processor during the subsequent scan.

## Output Response

The SLC processor may change the module output data (configuration) as it appears in the processor output image. However, this data is not transferred to the module. The outputs are held in their last state. When the slot is re-enabled, the current data in the processor image is transferred to the module.

## Channel Filter Frequency Selection

The module uses a digital low pass filter that provides noise rejection for the input signals. The digital filter is programmable, allowing you to select from eight filter frequencies for each channel.

Selecting a low value (i.e., 1 Hz) for the channel filter frequency provides the best noise rejection for a channel. Selecting a high value for the channel filter frequency provides lower noise rejection and faster step response time. See page 4-10 for more information on noise rejection.

The following table shows the available filter frequencies and step response for each filter frequency.

Filter Frequency	Step Response Time		
	1% Accuracy <sup>①</sup>	0.1% Accuracy <sup>①</sup>	0.05% Accuracy <sup>①</sup>
1 Hz	730 msec + module update time	1100 msec + module update time	1200 msec + module update time
2 Hz	365 msec + module update time	550 msec + module update time	600 msec + module update time
5 Hz	146 msec + module update time	220 msec + module update time	240 msec + module update time
10 Hz	73 msec + module update time	110 msec + module update time	120 msec + module update time
20 Hz	36.5 msec + module update time	55 msec + module update time	60 msec + module update time
50 Hz	14.5 msec + module update time	22 msec + module update time	24 msec + module update time
75 Hz	10 msec + module update time	15 msec + module update time	18 msec + module update time
no filter	0.5 msec + module update time	0.75 msec + module update time	0.75 msec + module update time

<sup>①</sup> The module accuracy for current inputs is 0.05%, and for voltage inputs is 0.1%.

## Channel Step Response

The channel filter frequency determines the channel's step response. The step response is time required for the channel data word to reach a specified percentage of its expected final value. This means that if an input signal changes faster than the channel step response, a portion of that signal will be attenuated by the channel filter. The table above shows the step response for each filter frequency.

## Channel Frequency

### Channel Cut-Off Frequency

The channel filter frequency selection determines a channel's cut-off frequency, also called the -3 dB frequency. The cut-off frequency is defined as the point on the input channel frequency response curve where frequency components of the input signal are passed with 3 dB of attenuation. All frequency components at or below the cut-off frequency are passed by the digital filter with less than 3 dB of attenuation. All frequency components above the cut-off frequency are increasingly attenuated.

The cut-off frequency for each input channel is defined by its filter frequency selection. Choose a filter frequency so that your fastest changing signal is below that of the filter's cut-off frequency. The cut-off frequency should not be confused with update time. The cut-off frequency relates how the digital filter attenuates frequency components of the input signal. The update time defines the rate at which an input channel is scanned and its channel data word is updated.

### Aliasing Frequency

Aliasing is a natural characteristic of discrete time sampling of analog signals. This can result in erroneous data in the data channel word. Aliasing is usually not a problem because the duration of the high frequency signal is much shorter than the program scan time.

Aliasing begins at a lower frequency when more channels are enabled. Anti-aliasing filters are available, but it is recommended that you first check your transducer for malfunctions as the filters are fairly expensive.

Aliasing occurs when unwanted signals, at a frequency greater than the effective sampling rate, are present. The effective sampling rate is determined by the number of enabled channels (n). The first aliasing frequency occurs at:  $f_a = 1 / (n * 0.00075)$ . Subsequent aliasing frequencies occur at integer multiples of  $f_a$ . The following table shows the first alias frequency, based on the number of channels enabled.

Aliasing Frequency for Number of Channels Enabled							
1 Channel	2 Channels	3 Channels	4 Channels	5 Channels	6 Channels	7 Channels	8 Channels
1333 Hz	666 Hz	444 Hz	333 Hz	267 Hz	222 Hz	190 Hz	167 Hz

The graph below shows the aliasing characteristic at a filter frequency of 10 Hz with one channel enabled.

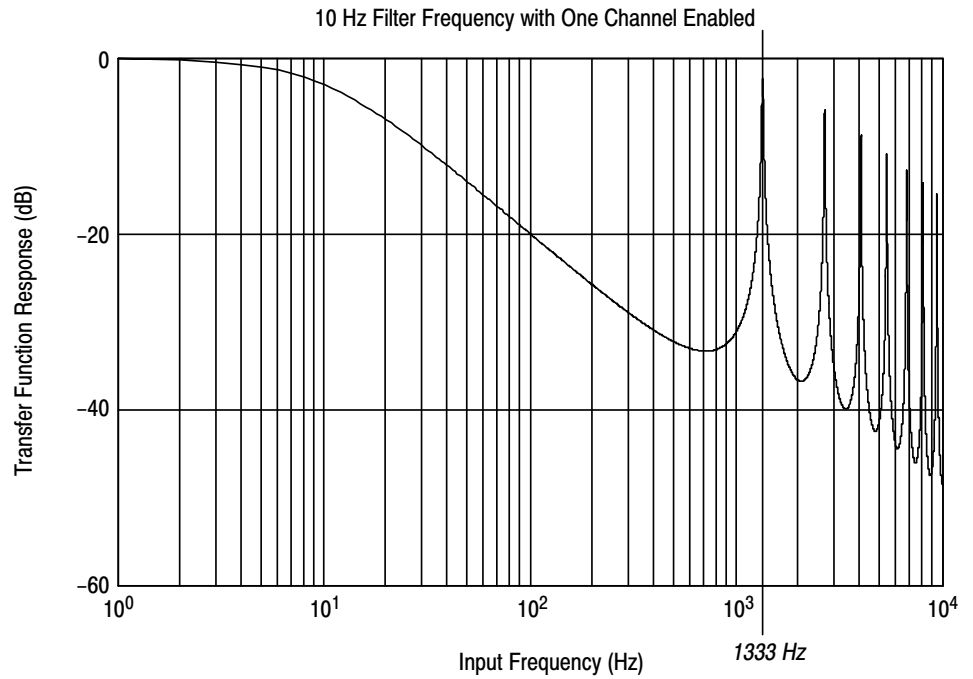

The graph below shows the aliasing characteristic at a filter frequency of 10 Hz with eight channels enabled.

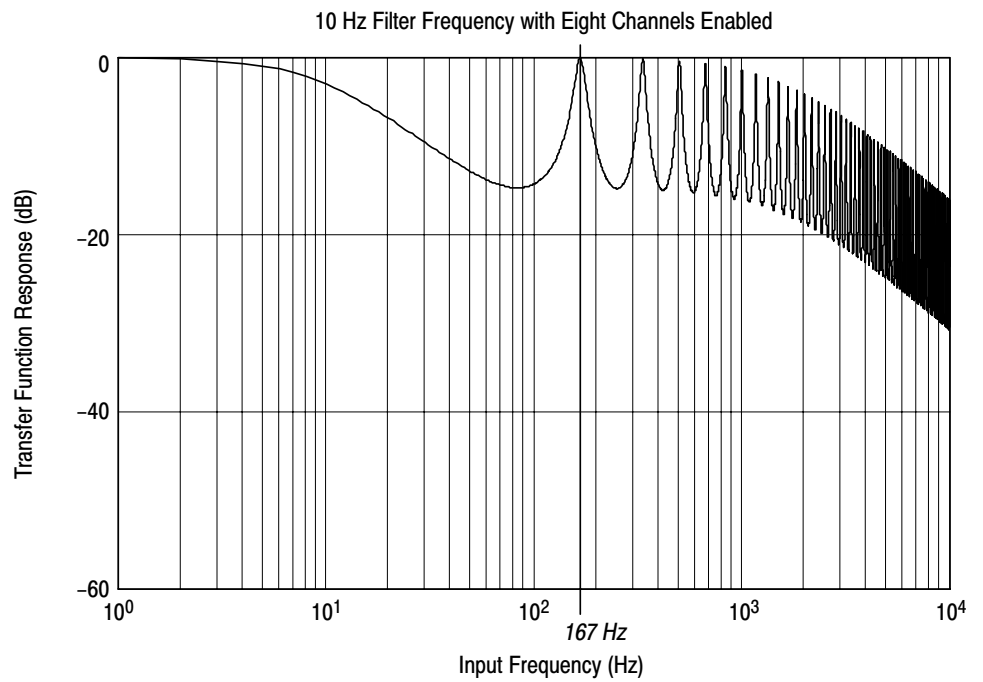



**Noise Rejection**

Rejection of common mode noise is inherent in the hardware design of the module. Common Mode Rejection is better than  $-75$  dB for common mode DC signals and better than  $-100$  dB for common mode 50 Hz and 60 Hz AC signals. The module performs well in the presence of common mode noise as long as the signals applied to the user terminals do not exceed the common mode voltage rating ( $\pm 10.5$  Volts) of the module. Improper earth/chassis ground connections may be a source of common mode noise.

Rejection of normal mode noise is implemented in the firmware and is a function of the filter frequency selected by the user. A lower frequency filter will reject more normal mode noise than a higher frequency filter. Transducer power supply noise, transducer circuit noise, or process variable irregularities may be sources of normal mode noise.

## Channel Configuration, Data, and Status

This chapter examines the channel configuration word and the channel status word bit by bit, and explains how the module uses configuration data and generates status during operation. It gives you information about how to:

- configure a channel
- scale the channel data
- check a channel's status

### Channel Configuration

The channel configuration word is a part of the 1746-NI8 module's output image as shown below. The module output image uses 8 word values when the module is in Class 1 mode, and 12 word values when the module is in Class 3 mode. A description of the output image is shown below.

1746-NI8 Module Output Image – Channel Configuration			Class 1	Class 3
O:e.0	channel 0 configuration word	bit mapped field	•	•
O:e.1	channel 1 configuration word	bit mapped field	•	•
O:e.2	channel 2 configuration word	bit mapped field	•	•
O:e.3	channel 3 configuration word	bit mapped field	•	•
O:e.4	channel 4 configuration word	bit mapped field	•	•
O:e.5	channel 5 configuration word	bit mapped field	•	•
O:e.6	channel 6 configuration word	bit mapped field	•	•
O:e.7	channel 7 configuration word	bit mapped field	•	•
O:e.8	lower scale limit range 0	16 bit integer		•
O:e.9	upper scale limit range 0	16 bit integer		•
O:e.10	lower scale limit range 1	16 bit integer		•
O:e.11	upper scale limit range 1	16 bit integer		•

After module installation (and voltage or current is selected via the DIP switches) each channel must be configured to establish the way the channel operates. You configure the channel by entering bit values into the configuration word using your programming device. A bit-by-bit examination of the configuration word is provided in the chart on page 5–2. Programming is discussed in chapter 6. Addressing is explained in chapter 4.

The configuration word default setting is all zeros.

## Channel Configuration Procedure

The channel configuration word consists of bit fields, the settings of which determine how the channel will operate. See the chart below and the descriptions that follow for configuration information. Appendix B contains a configuration worksheet.

After determining the configuration for each channel, follow the steps outlined in chapter 2, *Quick Start*, or in chapter 6, *Ladder Logic Configuration Examples*, to enter this configuration data into your ladder program and copy it to the 1746-NI8 module.

**Channel Configuration Word (O:e.0 through O:e.11) – Bit Definitions**

Bit(s)	Define	To Select <sup>①</sup>	Make these bit settings in the Channel Configuration Word																	
			15	14	13	12	11	10	9	8	7	6	5	4	3	2	1	0		
0-2	Input Type	SET DIP SWITCH TO "OFF" FOR VOLTAGE INPUT	± 10V dc														0	0	0	
			1-5V dc															0	0	1
			0-5V dc															0	1	0
			0-10V dc															0	1	1
		SET DIP SWITCH TO "ON" FOR CURRENT INPUT	0-20 mA															1	0	0
			4-20 mA															1	0	1
			± 20 mA															1	1	0
			0-1 mA															1	1	1
3-5	Data Format	Engineering Units														0	0	0		
		Scaled-for-PID														0	0	1		
		Proportional Counts														0	1	0		
		1746-NI4 Data Format														0	1	1		
		User Defined (Class 3)														1	0	0		
		User Defined (Class 3)														1	0	1		
		Illegal (configuration error)																		
		Illegal (configuration error)																		
6 and 7	Open Circuit	Zero														0	0			
		Upscale														0	1			
		Downscale														1	0			
		Illegal																		
8-10	Filter Frequency	No Filter						0	0	0										
		75 Hz						0	0	1										
		50 Hz						0	1	0										
		20 Hz						0	1	1										
		10 Hz						1	0	0										
		5 Hz						1	0	1										
		2 Hz						1	1	0										
		1 Hz						1	1	1										
11	Channel Enable	Channel Disabled					0													
		Channel Enabled					1													
12-15	Unused	Unused <sup>②</sup>	0	0	0	0														

<sup>①</sup> In addition to programming the configuration word, you must also use the DIP switches to select voltage or current.

<sup>②</sup> Ensure unused bits 12-15 are always be set to zeros.

### Select Input Type (Bits 0-2)

The input type bit field lets you configure the channel for the type of input device you have connected to the module. Valid input is an analog voltage or current that provides a signal within one of the specified ranges.

Determine the input device type for a channel and enter its respective 3-digit binary code in bit field 0-2 of the channel configuration word. You must also set the DIP switches of the module for voltage or current.

### Select Data Format (Bits 3-5)

Select a data format for the data word value. Your selection determines how the analog input value from the A/D converter will be expressed in the data word. Enter your 3-digit binary code in bit field 3-5 of the channel configuration word.

The data types are engineering units, scaled-for-PID, proportional counts, 1746-NI4 data format, and user defined scaling for Class 3 operation only. For all data types, the channel data word is proportional to the analog input signal.

To have the data in “real” units, the channel data word must be scaled mathematically. See *Channel Data Word* on page 5-5 for the default scaling values and *Scaling the Data Channel Word* on page 5-6 for data type descriptions and scaling examples.

### Select Open Circuit State (Bits 6 and 7)

Determine the desired state for the channel data word if an open circuit condition is detected for that channel. Enter the 2-digit binary code in bit field 6-7 of the channel configuration word. Open circuit errors are only detected for 4-20 mA input types (bits 6-7 are ignored for other input types). The open circuit options are zero, upscale, and downscale.

- If zero is selected, the channel data word is forced to 0 during an open-circuit condition.
- Selecting upscale forces the channel data word value to its full scale value during an open-circuit condition. The full scale value is determined by the selected input type and data format.
- Selecting downscale forces the channel data word value to its low scale value during an open-circuit condition. The low scale value is determined by the selected input type and data format.

**Important:** The processor may continue receiving data values for a period of time after the open circuit condition occurs until when the condition is flagged. The module indicates an open circuit within one module scan times. The module response time is shown below.

Module Response to Open Circuit	
Number of Channels Enabled	Response Time (maximum)
1	0.75 msec
2	1.50 msec
3	2.25 msec
4	3.00 msec
5	3.75 msec
6	4.50 msec
7	5.25 msec
8	6.00 msec

### Select Channel Filter Frequency (Bits 8-10)

Determine the desired input filter frequency for the channel and enter the 3-digit binary code in bit field 8-10 of the channel configuration word.

The channel filter frequency bit field lets you select one of 8 filters available for a channel. The filter frequency affects the noise rejection characteristics. A lower filter frequency increases the noise rejection, and a higher filter frequency decreases the noise rejection. Select a filter frequency considering acceptable noise and step response time. See Channel Filter Frequency Selection on page 4-7 for more information on filter frequency.

### Select Channel Enable (Bit 11)

Determine which channels are used in your program and enable them. Place a one in bit 11 if the channel is to be enabled. Place a zero in bit 11 if the channel is to be disabled.

The 1746-NI8 module only scans those channels that are enabled. To optimize module operation and minimize throughput times, *unused channels should be disabled* by setting the channel enable bit to zero.

When set (1) the channel enable bit is used by the module to read the configuration word information you have selected. While the enable bit is set, modification of the configuration word may lengthen the module update time for one cycle. If any change is made to the configuration word, the change must be reflected in the status word before new data is valid.

While the channel enable bit is cleared (0), the channel data word and status word values are cleared. After the channel enable bit is set, the channel data word and status word remain cleared until the module sets the channel status bit (bit 11) in the channel status word. (Refer to Channel Status on page 5-11.)

### Unused Bits (Bits 12-15)

Bits 12-15 are not defined. Ensure these bits are always set to zero.

## Channel Data Word

The module input image uses 8 data word values whether the module is in Class 1 or Class 3 mode. The converted voltage or current input data values reside in I:e.0 through I:e.7 of the module's input image file. When an input channel is disabled, its data word is reset to zero.

1746-NI8 Module Input Image - Data Word				
			Class 1	Class 3
I:e.0	channel 0 data word	16 bit integer	•	•
I:e.1	channel 1 data word	16 bit integer	•	•
I:e.2	channel 2 data word	16 bit integer	•	•
I:e.3	channel 3 data word	16 bit integer	•	•
I:e.4	channel 4 data word	16 bit integer	•	•
I:e.5	channel 5 data word	16 bit integer	•	•
I:e.6	channel 6 data word	16 bit integer	•	•
I:e.7	channel 7 data word	16 bit integer	•	•

The channel data word contains a 16-bit integer that represents the value of the analog input channel. The tables below show the channel data word values for various input types and data formats. The second table shows the default full-scale values for the proportional counts data format. The table does not imply the entire data value range is usable resolution.

Channel Data Word Values for Engineering Units			
Input Type	Signal Range	Engineering Units	Engineering Units Scale
±10V dc	-10.25V to +10.25V	-10250 to +10250	1mV/step
0-5V dc	-0.5V to +5.5V	-500 to +5500	1mV/step
1-5V dc	+0.5V to +5.5V	+500 to +5500	1mV/step
0-10V dc	-0.5V to +10.25V	-500 to +10250	1mV/step
0-20 mA	-0.5 mA to 20.5 mA	-500 to 20500	1.0uA/step
4-20 mA	3.5 mA to 20.5 mA	3500 to 20500	1.0uA/step
±20 mA	-20.5 mA to 20.5 mA	-20500 to 20500	1.0uA/step
0-1 mA	-0.05 mA to 1.05 mA	-50 to 1050	1.0uA/step

Channel Data Word Values for Scaled Data				
Input Type	Signal Range	Scaled-for-PID	Proportional Counts (default)	NI4 Data Format
±10V dc	-10.00V to +10.00V	0 to 16383	-32768 to 32767	-32768 to 32767
0-5V dc	0.0V to +5.00V	0 to 16383	-32768 to 32767	0 to 16384
1-5V dc	+1.00V to +5.00V	0 to 16383	-32768 to 32767	3277 to 16384
0-10V dc	0.0V to +10.00V	0 to 16383	-32768 to 32767	0 to 32767
0-20 mA	0.0 mA to 20.0 mA	0 to 16383	-32768 to 32767	0 to 16384
4-20 mA	4.0 mA to 20.0 mA	0 to 16383	-32768 to 32767	3277 to 16384
±20 mA	-20.0 mA to 20.0 mA	0 to 16383	-32768 to 32767	-16384 to 16384
0-1 mA	0.0 mA to 1.00 mA	0 to 16383	-32768 to 32767	0 to 1000 <sup>①</sup>

<sup>①</sup> This data format is not supported by the 1746-NI4 module, but is available for the 1746-NI8 module.

## Scaling the Channel Data Word

This section provides descriptions of how the data types are expressed in the channel data word and examples of how to mathematically convert the data.

### Data Type Descriptions

The **engineering units** are 1 mV/step for voltage input types, and 1.0  $\mu$ A/step for current input types.

The **scaled-for-PID** value is a 14-bit unsigned integer, with 0 representing the low scale value and 16,383 representing the full scale value minus 1 lsb. The input signal range is proportional to your selected input type and scaled into a 0-16,383 range, which is standard to the SLC PID algorithm.

The **proportional count** value is a 16-bit signed integer. The input signal range is proportional to your selected input and scaled into a -32,768 to 32,767 range.

The **1746-NI4 data format** converts the current and voltage signals into 16-bit 2's complement binary values. The table below identifies the current and voltage input ranges for the input channels, the number of significant bits, and the resolution.

Voltage/Current Range	Decimal Representation	Number of Significant Bits	Resolution per LSB
-10V dc to +10V dc - 1LSB	-32,768 to +32,767	16 bits	305.176 $\mu$ V
0 to 5V dc	0 to 16,384	14 bits	
1 to 5V dc	3,277 to 16,384	13.67 bits	
0 to 10V dc - 1LSB	0 to 32,767	15 bits	

Voltage/Current Range	Decimal Representation	Number of Significant Bits	Resolution per LSB
0 to 20 mA	0 to 16,384	14 bits	1.22070 $\mu$ A
4 to 20 mA	3,277 to 16,384	13.67 bits	
-20 mA to +20 mA	-16,384 to +16,384	15 bits	
0 to 1 mA	0 to 1000	10 bits	1 $\mu$ A <sup>①</sup>

① This data format is not supported by the 1746-NI4 module, but is available for the 1746-NI8 module.

**User defined scaling count** (Class 3 operation only) allows the output image data words 8 and 9 (or words 10 and 11) to be selected to represent low scale and high scale limits. The module uses these limits and scales proportionately between them. For example, if words 8 and 9 are selected to represent low and high scaling ranges (data format select bits = 100 binary), and word 8 contains 0000 hex (0 decimal), and word 9 contains 4E20 hex (20000 decimal), this would represent the range of values that the voltage or current readings would be scaled into. The lowest voltage or current reading would be scaled to 0, and the highest voltage or current reading would be scaled to 20000, with other readings scaled proportionately between them.

If the module is in Class 1 mode and you attempt to configure for user defined proportional counting, a configuration error will be generated.

### Using Scaled-for-PID and Proportional Counts

The scaled-for-PID and proportional count selections provide the highest display resolution, but also require you to manually convert the channel data to “real” units.



## Scaling Examples

The following scaling examples show how to convert the channel data word from the configured data type to “real” units. “Real” units are the values being measured such as temperature and pressure. To perform the scaling, you must know the defined voltage or current range for the channel’s input type. The lowest possible value for an input type is  $S_{LOW}$ , and the highest possible value is  $S_{HIGH}$ . Refer to the Channel Data Word Value tables on pages 5-5 and 5-6 for the data channel word ranges.

### Engineering Units to “Real” Units

Situation #1: A transducer is being used to measure temperature.  
 The 4–20 mA signal is proportional to 100–500°C (212–932°F).  
 The channel data word is in engineering units format.  
 The channel data = 5500.

Find: “Real” units equivalent in °F.

$$\text{Equation: } \textit{Real Units Equivalent} = \textit{channel data value} \times (\textit{scaling factor}) \times \left( \frac{S_{HIGH} - S_{LOW}}{\textit{input range}} \right)$$

where:  $S_{LOW} = 212^{\circ}\text{F}$   
 $S_{HIGH} = 932^{\circ}\text{F}$   
 channel data word = 5500  
 scaling for engineering units = 1  $\mu\text{A}$  per step

$$\text{Solution: } \textit{Real Units Equivalent} = 5500 \times (1 \mu\text{A}) \times \left( \frac{932^{\circ}\text{F} - 212^{\circ}\text{F}}{20 \text{ mA} - 4 \text{ mA}} \right) = 247.5^{\circ}\text{F}$$

Situation #2: A transducer is being used to measure temperature.  
 The 0–10V dc signal is proportional to 0–10°C.  
 The channel data word is in engineering units format.  
 The channel data = 5000.

Find: “Real” units equivalent in °C.

$$\text{Equation: } \textit{Real Units Equivalent} = \textit{channel data value} \times (\textit{scaling factor}) \times \left( \frac{S_{HIGH} - S_{LOW}}{\textit{input range}} \right)$$

where:  $S_{LOW} = 0^{\circ}\text{C}$   
 $S_{HIGH} = 10^{\circ}\text{C}$   
 channel data word = 5000  
 scaling for engineering units = 1 mV per step

$$\text{Solution: } \textit{Real Units Equivalent} = 5000 \times (1 \text{ mV}) \times \left( \frac{10^{\circ}\text{C} - 0^{\circ}\text{C}}{10\text{V dc} - 0\text{V dc}} \right) = 5.000^{\circ}\text{C}$$

► **TIP** If you are measuring a “real” voltage or current, then selecting engineering units allows the module to report “real” values without further scaling. For example, a 4.683V dc signal would produce a channel data word of 4683.

**Scaled-for-PID to “Real” Units**

Situation: A transducer is being used to measure temperature.  
 The 4–20 mA signal is proportional to 100–500°C (212–932°F).  
 The channel data word is in scaled-for-PID format.  
 The channel data = 5500.

Find: “Real” units equivalent in °F.

$$\text{Equation: } \textit{Real Units Equivalent} = S_{LOW} + \left[ (S_{HIGH} - S_{LOW}) \times \left( \frac{\textit{channel data value}}{\textit{full scale default PID value}} \right) \right]$$

where:  $S_{LOW} = 212^{\circ}F$   
 $S_{HIGH} = 932^{\circ}F$   
 channel data word = 5500  
 full scale PID default value (from table on page 5–6) = 16383

$$\text{Solution: } \textit{Real Units Equivalent} = 212^{\circ}F + \left[ (932^{\circ}F - 212^{\circ}F) \times \left( \frac{5500}{16383} \right) \right] = 453.71^{\circ}F$$

**Proportional Counts to “Real” Units**

Situation: A transducer is being used to measure pressure.  
 The –10V dc to +10V dc signal is proportional to 0 to 200 psi.  
 The channel data word is in proportional counts data format.  
 The channel data = 21567.

Find: “Real” units equivalent in psi.

Equation:

$$\textit{Real Units Equivalent} = S_{LOW} + \left[ (S_{HIGH} - S_{LOW}) \times \frac{(\textit{data value} + |\textit{proportional count low default value}|)}{(\textit{proportional count full scale default value})} \right]$$

where:  $S_{LOW} = 0 \text{ psi}$   
 $S_{HIGH} = 200 \text{ psi}$   
 channel data = 21567  
 proportional count low default value (from table on page 5–6) = –32768  
 proportional count full scale default value (from table on page 5–6) = 65535

$$\text{Solution: } \textit{Real Units Equivalent} = 0 \text{ psi} + \left[ (200 \text{ psi} - 0 \text{ psi}) \times \frac{(21567 + |-32768|)}{(65535)} \right] = 165.55 \text{ psi}$$

**1746-NI4 Data Format Units to “Real” Units**

Situation: A transducer is being used to measure flow rate.  
 The -10V dc to +10V dc signal is proportional to 0–100 GPM.  
 The channel data word is in 1746-NI4 data format.  
 The channel data = 10000.

Find: “Real” units equivalent in GPM.

$$\text{Equation: } \textit{Real Units Equivalent} = \textit{channel data value} \times \left( \frac{S_{\text{HIGH}} - S_{\text{LOW}}}{\textit{input range}} \right)$$

where:  $S_{\text{LOW}} = 0 \text{ GPM}$   
 $S_{\text{HIGH}} = 100 \text{ GPM}$   
 channel data word = 5500  
 NI4 full scale default value (from table on page 5–6) = 65535

$$\text{Solution: } \textit{Real Units Equivalent} = 10000 \times \left( \frac{100 \text{ GPM} - 0 \text{ GPM}}{65535} \right) = 15.26 \text{ GPM}$$

**User Defined Limits Data Format to “Real” Units**

Situation: A transducer is being used to measure pressure.  
 The -10V dc to +10V dc signal is proportional to 0–200 psi.  
 The channel data word is in user defined data format.  
 The lower scale limit (configuration word 8) = 0.  
 The upper scale limit (configuration word 9) = 20000.  
 The channel data word = 16600.

Find: “Real” units equivalent in psi.

$$\text{Equation: } \textit{Real Units Equivalent} = \textit{channel data word} \times \left[ \frac{(S_{\text{HIGH}} - S_{\text{LOW}})}{(\textit{upper scale limit} - \textit{lower scale limit})} \right]$$

where:  $S_{\text{LOW}} = 0 \text{ psi}$   
 $S_{\text{HIGH}} = 200 \text{ psi}$

$$\text{Solution: } \textit{Real Units Equivalent} = 16600 \times \left[ \frac{(200 \text{ psi} - 0 \text{ psi})}{(20000 - 0)} \right] = 166.00 \text{ psi}$$

## Channel Status Checking

If the module is in Class 3 mode, there are an additional 8 input image words available for status information. The channel status word is a part of the module's input image. Input words 8-15 correspond to and contain the configuration status of channels 0-7. You can use the data provided in the status word to determine if the input configuration data for any channel is valid per your configuration in O:e.0 through O:e.7.

For example, whenever a channel is disabled ( $O:e.x/11 = 0$ ), its corresponding status word shows all zeros. This condition tells you that input data contained in the data word for that channel is not valid and should be ignored.

1746-NI8 Module Input Image - Status Word				
			Class 1	Class 3
I:e.8	channel 0 status word	bit mapped field		•
I:e.9	channel 1 status word	bit mapped field		•
I:e.10	channel 2 status word	bit mapped field		•
I:e.11	channel 3 status word	bit mapped field		•
I:e.12	channel 4 status word	bit mapped field		•
I:e.13	channel 5 status word	bit mapped field		•
I:e.14	channel 6 status word	bit mapped field		•
I:e.15	channel 7 status word	bit mapped field		•

The channel status word can be analyzed bit by bit. In addition to providing information about an enabled or disabled channel, each bit's status (0 or 1) tells you how the input data from the voltage or current analog sensor connected to a specific channel will be translated for your application. The bit status also informs you of any error condition and can tell you what type of error occurred.

A bit-by-bit examination of the status word is provided in the chart on the following page.

Channel 0-7 Status Word (I:e.8 through I:e.15) - Bit Definitions

Bit(s)	Define	These bit settings															Indicate this	
		15	14	13	12	11	10	9	8	7	6	5	4	3	2	1		0
0-2	Input Type														0	0	0	± 10 V dc
															0	0	1	1-5V dc
															0	1	0	0-5V dc
															0	1	1	0-10V dc
															1	0	0	0-20 mA
															1	0	1	4-20 mA
															1	1	0	± 20 mA
													1	1	1	0-1 mA		
3-5	Data Format											0	0	0				Engineering Units
												0	0	1				Scaled-for-PID
												0	1	0				Proportional Counts
												0	1	1				1746-NI4 Data Format
												1	0	0				User Defined (Class 3)
												1	0	1				User Defined (Class 3)
																		Illegal (configuration error)
																Illegal (configuration error)		
6 and 7	Open Circuit									0	0						Zero	
										0	1						Upscale	
										1	0						Downscale	
																	Illegal (configuration error)	
8-10	Filter Frequency						0	0	0								No Filter	
							0	0	1								75 Hz	
							0	1	0								50 Hz	
							0	1	1								20 Hz	
							1	0	0								10 Hz	
							1	0	1								5 Hz	
							1	1	0								2 Hz	
							1	1	1								1 Hz	
11	Channel Status					0											Channel Disabled	
						1											Channel Enabled	
12	Open Circuit Error				0												No Error	
					1												Open Circuit Detected	
13	Over-Range Error			0													No error	
				1													Over-Range Condition	
14	Under-Range Error		0														No Error	
			1														Under-Range Condition	
15	Configuration Error	0															No Error	
		1															Configuration Error	

**Important:** If the channel for which you are seeking status is disabled (bit O:e.x/11 = 0), all bit fields are cleared. The status word for any disabled channel is always 0000 0000 0000 0000 regardless of any previous setting that may have been made to the configuration word.

Explanations of the status conditions follow.

### **Input Type Status (Bits 0-2)**

The input type bit field indicates what type of input signal you have configured for the channel. This field reflects the input type defined in the channel configuration word. The input field is cleared when the channel is disabled.

### **Data Format Type Status (Bits 3-5)**

The data format bit field indicates the data format you have defined for the channel. This field reflects the data type selected in the channel configuration word. The data format field is cleared when the channel is disabled.

### **Open Circuit Type Status (Bits 6 and 7)**

The open circuit bit field indicates how you have defined the response of the module to an open circuit condition. This feature is active for the 4–20 mA input type only. The open circuit field is cleared when the channel is disabled.

### **Channel Filter Frequency (Bits 8-10)**

The channel filter frequency bit field reflects the filter frequency you selected in the configuration word. This feature is active for all current and voltage input types. The filter frequency bit field is cleared while the channel is disabled.

### **Channel Status (Bit 11)**

The channel status bit indicates the operational state of the channel. Once the channel enable bit is set, the module will configure the channel and take the first data sample of the channel data word before setting the channel status bit. The channel status bit is cleared upon power up and reset.

**Open Circuit Error (Bit 12)**

The open circuit error bit is set (1) whenever the channel detects an open circuit condition at its input. The open circuit error is active for the 4–20 mA input type only. The open circuit error state will always take precedence over the out-of-range error states. There will never be an out-of-range error when an open circuit is detected. The open circuit error bit is cleared when the channel is disabled or when the open circuit condition is removed.

**Over-Range Error (Bit 13)**

The over-range error bit is set (1) whenever a configured channel detects an over-range condition for the channel data. An over-range condition exists when the input value is above the specified upper limit of the particular sensor connected to that channel. The over-range bit is cleared when the channel is disabled.

**Under-Range Error (Bit 14)**

The under-range error bit is set (1) whenever a configured channel detects an under-range condition for the channel data. An under-range condition exists when the input value is below the specified lower limit of the particular sensor connected to that channel. The under-range bit is cleared when the channel is disabled.

**Configuration Error (Bit 15)**

The configuration error bit is set (1) whenever a configured channel detects that the channel configuration word is not valid. All other status bits reflect the settings from the configuration word (even those settings that may be in error). The configuration error bit is cleared when the channel is disabled.

## Ladder Logic Configuration Examples

Earlier chapters explained how the configuration word defines the way a channel operates. This chapter shows the programming required to enter the configuration word into the processor memory. It also provides you with segments of ladder logic specific to unique situations that might apply to your programming requirements. The example segments include:

- initial programming of the configuration word
- interfacing the analog module to a PID instruction
- monitoring channel status bits (Class 3 Mode only)

### Initial Programming

To enter data into the channel configuration word (O:e.0 through O:e.7) when the channel is disabled (bit 11 = 0), follow these steps. Refer to page 5-2 for specific configuration details.

**Example** - A 1746-NI8 analog module is residing in slot 3 of a 1746 chassis. Configure all eight channels with the same parameters.

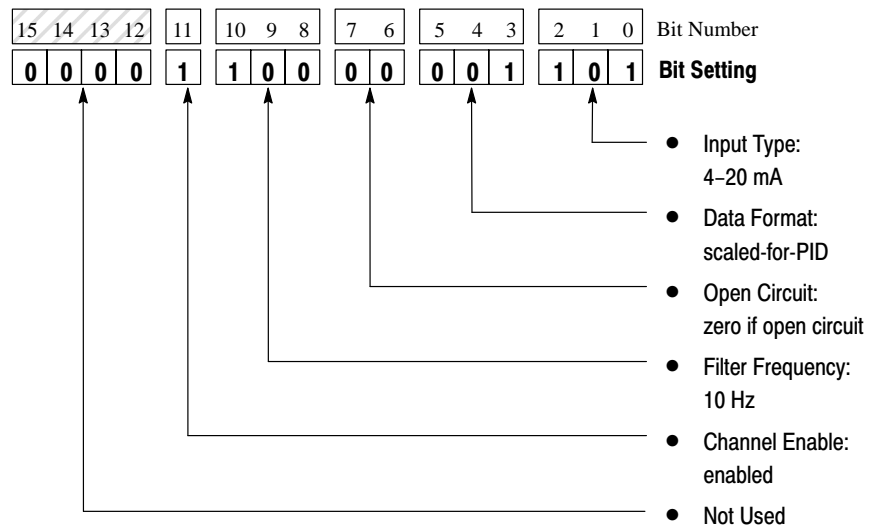

This example transfers configuration data and sets the channel enable bits of all eight channels with a single File Copy instruction.



## Procedure

1. Create integer file N10. Integer file N10 should contain eight elements (N10:0 through N10:7).
2. Enter the configuration parameters for all eight analog input channels into a source integer data file **N10**. See Appendix B for the channel configuration worksheet.
3. Program a rung in your ladder logic to copy the contents of integer file N10 to the eight consecutive output words of the 1746-NI8 analog module beginning with word O:3.0.

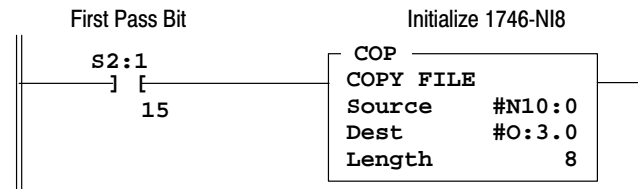

On power up, bit S2:1/15 is set for the first program scan, and integer file N10 is sent to the eight 1746-NI8 channel configuration words.

### DATA FILE N10

Offset	15	14	13	12	11	10	9	8	7	6	5	4	3	2	1	0
N10:0	0	0	0	0	1	1	0	0	0	0	0	0	1	1	0	1
N10:1	0	0	0	0	1	1	0	0	0	0	0	0	1	1	0	1
N10:2	0	0	0	0	1	1	0	0	0	0	0	0	1	1	0	1
N10:3	0	0	0	0	1	1	0	0	0	0	0	0	1	1	0	1
N10:4	0	0	0	0	1	1	0	0	0	0	0	0	1	1	0	1
N10:5	0	0	0	0	1	1	0	0	0	0	0	0	1	1	0	1
N10:6	0	0	0	0	1	1	0	0	0	0	0	0	1	1	0	1
N10:7	0	0	0	0	1	1	0	0	0	0	0	0	1	1	0	1

## Interfacing to the PID Instruction

The analog input module was designed to interface directly to the SLC 5/02™ or later processor PID instruction without the need for an intermediate scale operation.

**Example** - Use 1746-NI8 channel data as the process variable in the PID instruction.

1. Select *scaled-for-PID* as the data format in the channel configuration word.
2. Specify the 1746-NI8 channel data word as the process variable for the PID instruction.

### Program Listing

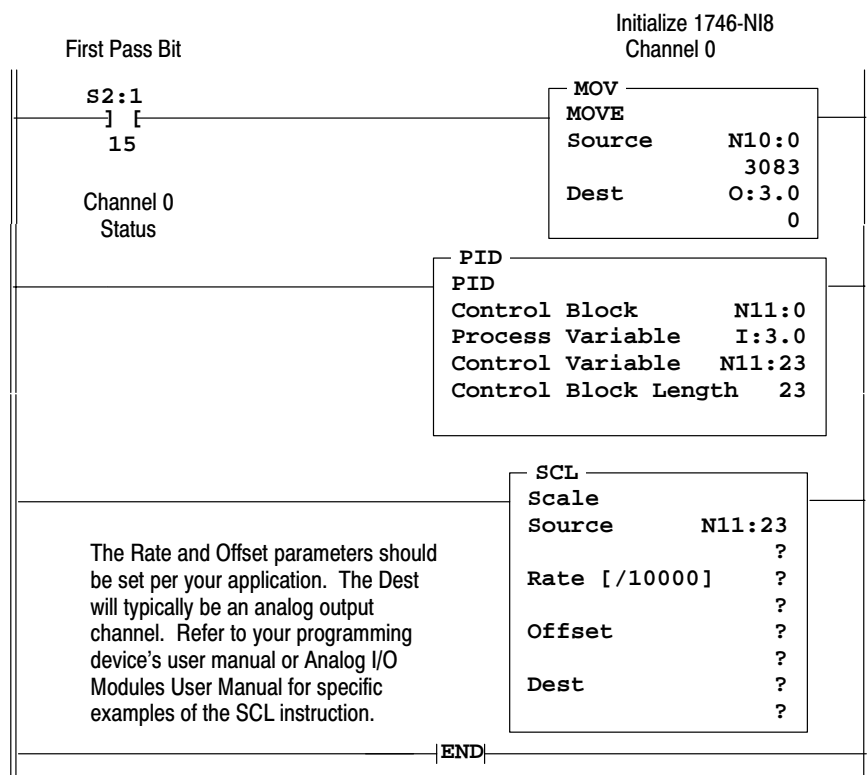

### DATA FILE N10

Offset	15	14	13	12	11	10	9	8	7	6	5	4	3	2	1	0
N10:0	0	0	0	0	1	1	0	0	0	0	0	0	1	1	0	1

### Monitoring Channel Status Bits (Class 3 Mode Only)

This example shows how you could monitor the open circuit error bits of each channel and set an alarm in the processor if one of the channels opens. An open circuit error can occur if the analog input device breaks, or one of the sensor wires gets cut or disconnected from the terminal block.

#### Program Listing

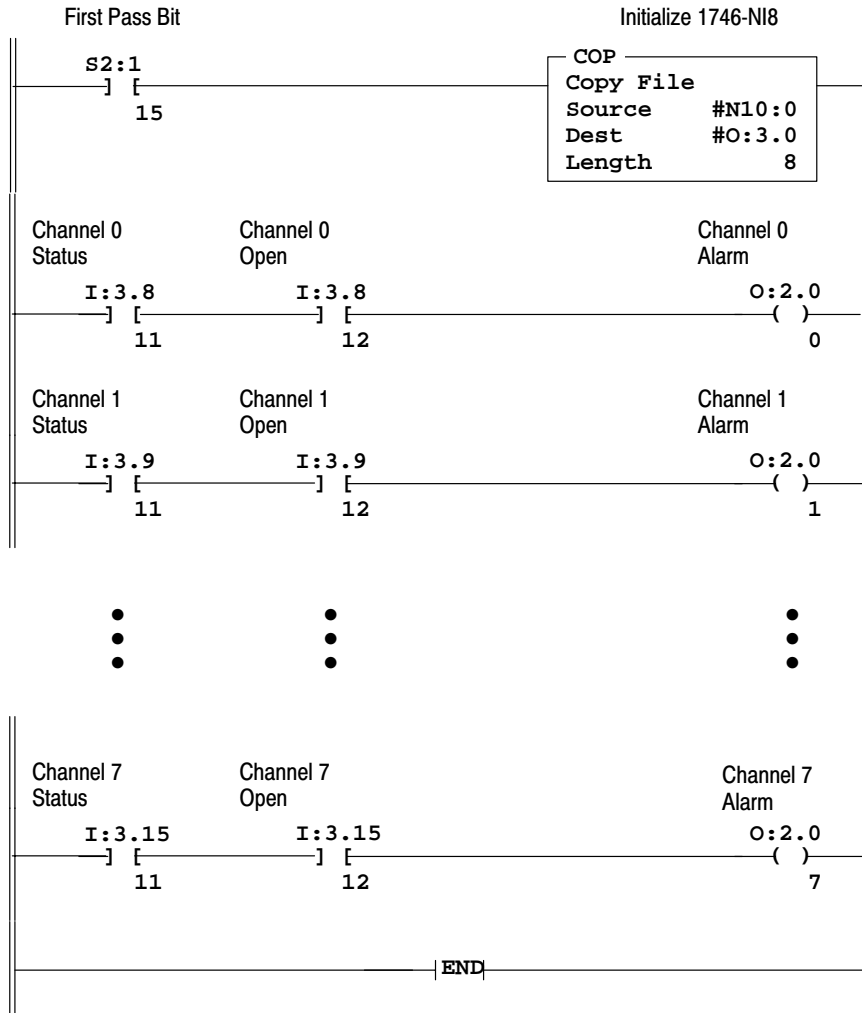

#### DATA FILE N10

Offset	15	14	13	12	11	10	9	8	7	6	5	4	3	2	1	0
N10:0	0	0	0	0	1	1	0	0	0	0	0	0	1	1	0	1
N10:1	0	0	0	0	1	1	0	0	0	0	0	0	1	1	0	1
N10:2	0	0	0	0	1	1	0	0	0	0	0	0	1	1	0	1
N10:3	0	0	0	0	1	1	0	0	0	0	0	0	1	1	0	1
N10:4	0	0	0	0	1	1	0	0	0	0	0	0	1	1	0	1
N10:5	0	0	0	0	1	1	0	0	0	0	0	0	1	1	0	1
N10:6	0	0	0	0	1	1	0	0	0	0	0	0	1	1	0	1
N10:7	0	0	0	0	1	1	0	0	0	0	0	0	1	1	0	1

## Module Diagnostics and Troubleshooting

This chapter describes troubleshooting using the channel status LEDs as well as the module status LED. It explains the types of conditions that might cause an error to be reported and gives suggestions on how to resolve the problem. Major topics include:

- module operation vs. channel operation
- power-up diagnostics
- channel diagnostics
- LED indicators
- troubleshooting flowchart
- replacement parts
- contacting Allen-Bradley

### Module Operation vs. Channel Operation

The module performs operations at two levels:

- module level operations
- channel level operations

Module level operations include functions such as power-up configuration and communication with the SLC processor.

Channel level operations describe channel-related functions, such as data conversion and open-circuit detection.

Internal diagnostics are performed at both levels of operation and any error conditions detected are immediately indicated by the module's LEDs.

### Power-Up Diagnostics

At module powerup, a series of internal diagnostic tests is performed. These diagnostic tests must be successfully completed or a module error results and the module status LED remains off.

### Channel Diagnostics

When a channel is enabled (bit 11 = 1), a diagnostic check is performed to see that the channel has been properly configured. In addition the channel is tested on every scan for configuration errors, over-range, under-range, and, for the 4–20 mA input type, open-circuit conditions.

A failure of any channel diagnostic test causes the faulted channel status LED to blink. All channel faults are indicated in bits 12–15 of the channel’s status word. Channel faults are self-clearing. When the fault conditions are corrected, the channel status LED will stop blinking and resume steady illumination.

**Important:** If you clear (0) a channel enable bit (11) all channel status information is reset.

## LED Indicators

The module has nine LEDs. Eight of these are channel status LEDs numbered to correspond to each of the input channels, and one is a module status LED.

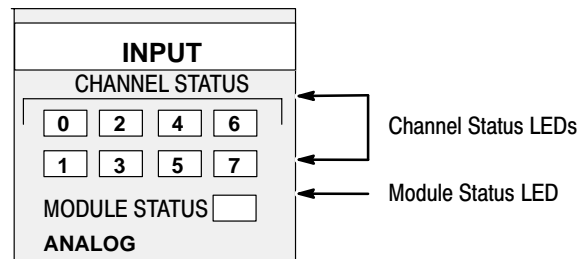

LED State Table

If Module Status LED is:	And Channel Status LED is:	Indicated Condition:	Corrective action:
On	On	Channel Enabled	No action required.
	Blinking	Open-Circuit Condition	To determine the exact error, check the error bits in the input image. Check the channel configuration word for valid data. Make sure that the data format is indicated correctly in bits 3–5, and that the open-circuit selection state (bits 6 and 7) is valid. Refer to the troubleshooting flowchart on page 7-5 and to chapter 5 for more information.
		Out-of-Range Condition	
		Channel Configuration Error	
	Off	Power-Up	No action required.
Channel Not Enabled		No action required. For an example of how to enable a channel refer to chapter 2, Quick Start, or chapter 6, Ladder Logic Configuration Examples.	

Module Status LED State Table

If Module Status LED is:	Indicated condition:	Corrective action:
On	Proper Operation	No action required.
Off	Module Fault	Cycle power. If condition persists, call your local distributor or Allen-Bradley for assistance.

## Channel Status LEDs (Green)

The channel status LED is used to indicate channel status and related error information contained in the channel status word. This includes conditions such as:

- normal operation
- channel-related configuration errors
- open-circuit errors
- out-of-range errors

All channel errors are recoverable errors and after corrective action, normal operation resumes.

### Invalid Channel Configuration

Whenever a channel's configuration word is improperly defined, the channel status LED blinks and bit 15 of the channel status word is set. Configuration errors occur when the data format (bits 3–5 in the channel configuration word) is invalid, or when the open-circuit state selection (bits 6 and 7) is invalid.

### Open-Circuit Detection

An open-circuit test is performed on all enabled channels configured for 4–20 mA input. Whenever an open-circuit condition occurs (see possible causes listed below), the channel status LED blinks and bit 12 of the channel status word is set.

Possible causes of an open-circuit include:

- The sensing device may be broken.
- A wire may be loose or cut.
- The sensing device may not have been installed on the configured channel.

If an open-circuit is detected, the channel data word reflects input data as defined by the open-circuit bits (6 and 7) in the channel configuration word.

### Out-Of-Range Detection

Whenever the data received at the channel data word is out of the defined operating range, an over-range or under-range error is indicated and bit 13 (over-range) or bit 14 (under-range) of the channel status word is set.

**Module Status LED (Green)**

The module status LED is used to indicate module-related diagnostic or operating errors. These *non-recoverable errors* may be detected at power-up or during module operation. Once in a module error state, the 1746-NI8 module no longer communicates with the SLC processor. Channel states are disabled, and data words are cleared.

Failure of any diagnostic test results in a non-recoverable error and requires the assistance of your local distributor or Allen-Bradley.

# Troubleshooting Flowchart

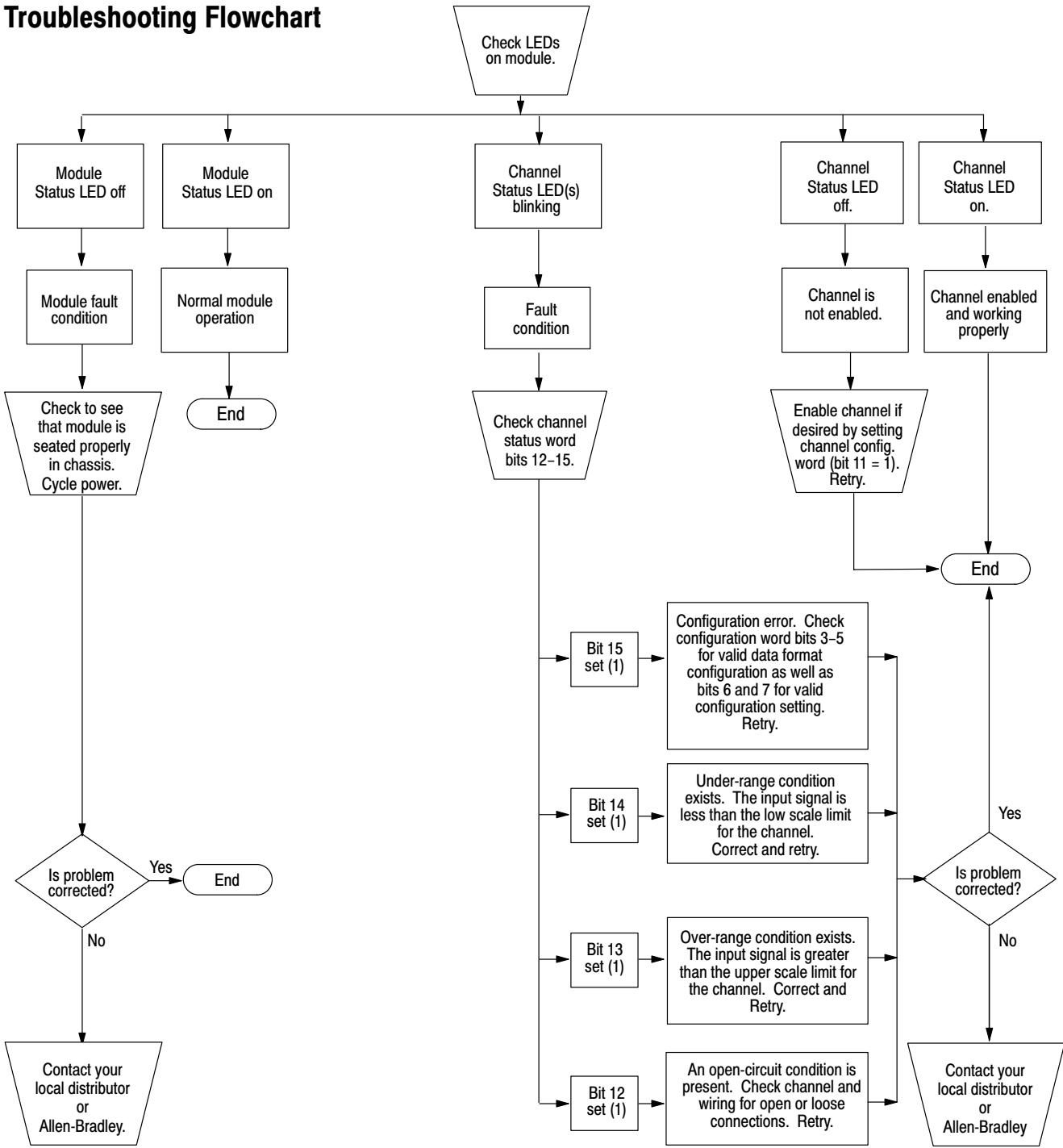



## Replacement Parts

The 1746-NI8 module has the following replaceable parts:

Part	Part Number
Replacement Terminal Block	1746-RT25G
Replacement Terminal Cover	1746-R13
1746-NI8 User Manual	1746-6.8

## Contacting Allen-Bradley

If you need to contact Allen-Bradley for assistance, please have the following information available when you call:

- a clear statement of the problem including a description of what the system is actually doing. Note and record the LED states; also, note input and output image words for the module.
- a list of things you have already tried to remedy the problem
- processor type and firmware (FRN) number. See label on left side of processor.
- hardware types in the system including I/O modules and chassis
- fault code if the SLC processor is faulted

## Application Examples

This chapter provides two application examples to help you use the analog input module. They are defined as a:

- basic example
- supplementary example

The **basic example** builds on the configuration word programming provided in chapter 6 to set up one channel for operation. This setup is then used in a typical application to display a current (amperage) value.

The **supplementary example** demonstrates how to perform a dynamic configuration of five of the eight available channels. The example sets up an application that allows you to manually select whether the current transducer data is displayed for L1, L2, or L3. The example also includes configuration and programming to display pressure and liquid level.

### Basic Example

#### Application Setup – Display a Current (amperage) Value

In this example, the current draw of a single-phase motor is shown on an LED display. The display requires BCD data, so the program must convert the current reading from the analog input module to BCD before sending it to the display.

#### Device Configuration

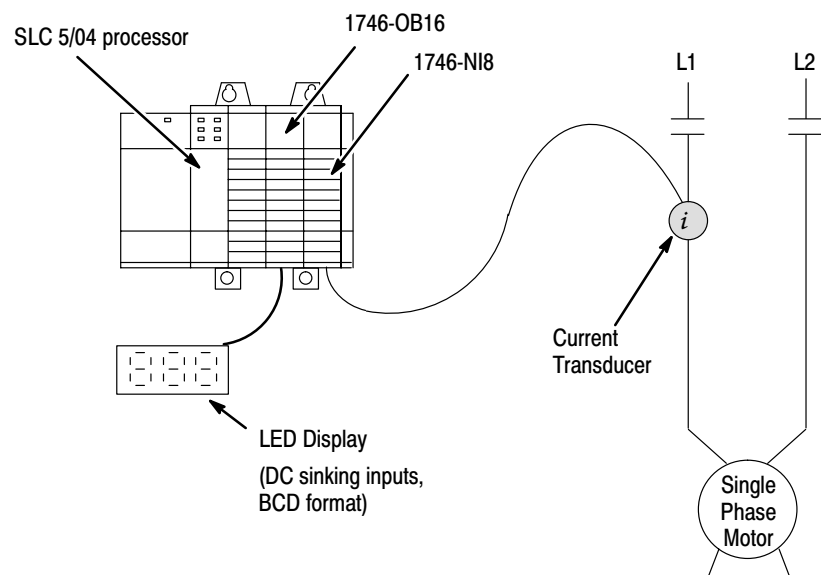

### Channel Configuration

Configure channel 0 of the 1746-NI8 module with the following setup:

- 4–20 mA input type
- engineering units data format
- zero data word in the event of an open circuit
- 10 Hz input filter to reject high frequency noise and provide rejection of 60 Hz line noise

### Channel Configuration Worksheet (With Settings Established for Channel 0)

15 14 13 12				11	10 9 8			7 6		5 4 3			2 1 0			Bit Number
0	0	0	0	1	1	0	0	0	0	0	0	0	1	0	1	Channel 0 – N10:0
0	0	0	0													Channel 1
0	0	0	0													Channel 2
0	0	0	0													Channel 3
0	0	0	0													Channel 4
0	0	0	0													Channel 5
0	0	0	0													Channel 6
0	0	0	0													Channel 7

  

- Input Type
- Data Format
- Open Circuit
- Filter Frequency
- Channel Enable
- Not Used

**Bit Definitions:**

<b>Bits 0-2</b>	Input Type	000 = ±10V dc 001 = 1-5V dc	010 = 0-5V dc 011 = 0-10V dc	100 = 0-20 mA 101 = 4-20 mA	110 = ±20 mA 111 = 0-1 mA
<b>Bits 3-5</b>	Data Format	000 = engineering units 001 = scaled-for-PID	010 = proportional counts 011 = 1746-NI4 data format	100 = user defined scaling 101 = user defined scaling	110 = illegal 111 = illegal
<b>Bits 6 and 7</b>	Open Circuit	00 = zero	01 = upscale	10 = downscale	11 = illegal
<b>Bits 8-10</b>	Filter Frequency	000 = no filter 001 = 75 Hz	010 = 50 Hz 011 = 20 Hz	100 = 10 Hz 101 = 5 Hz	110 = 2 Hz 111 = 1 Hz
<b>Bit 11</b>	Channel Enable	0 = channel disabled		1 = channel enabled	
<b>Bits 12-15</b>	Not Used	0000 = always make this setting			

### Program Listing

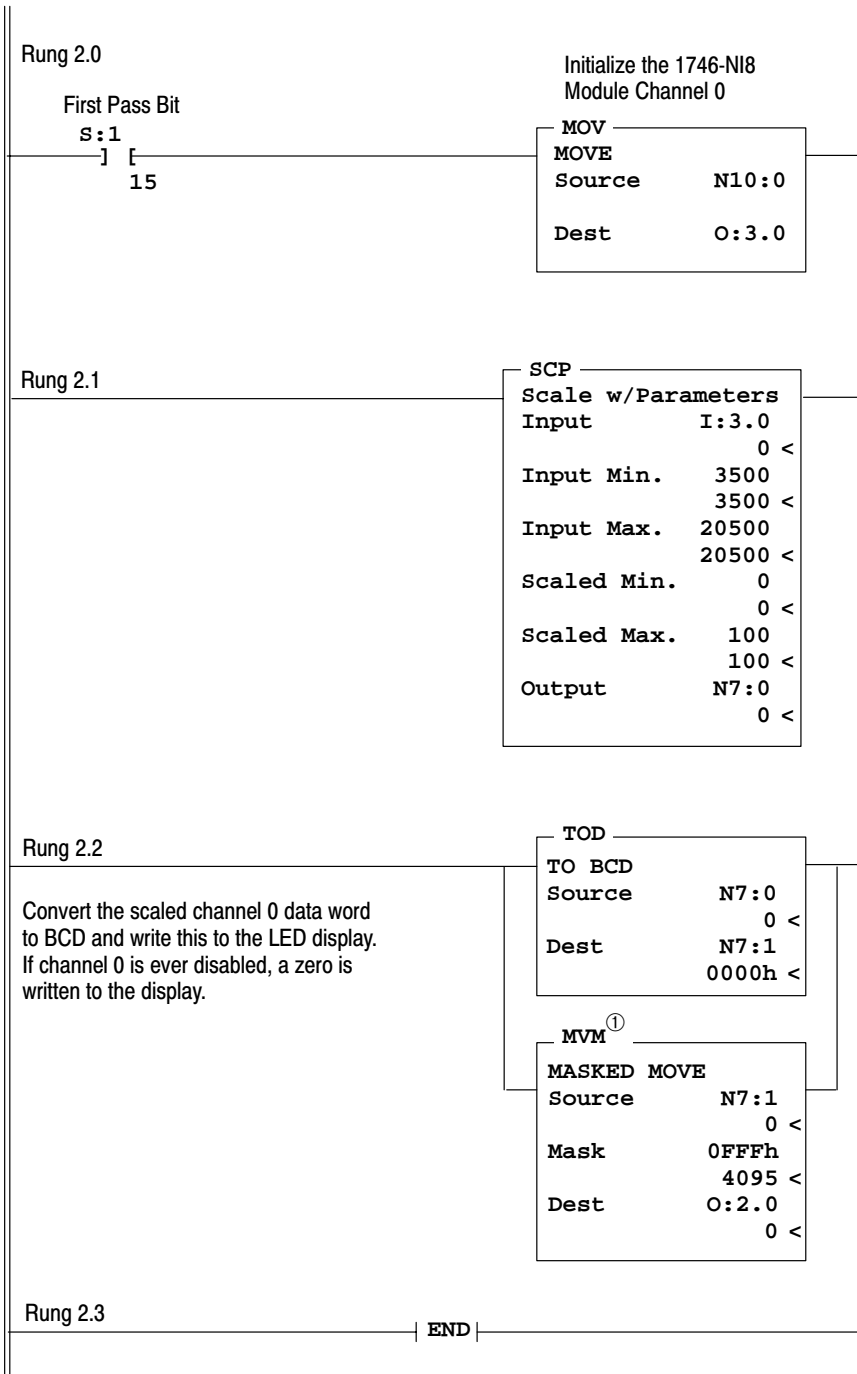

① The use of the masked move instruction with the 0FFF mask allows you to use outputs 12, 13, 14, and 15 for other output devices in your system. The 7-segment display uses outputs 0-11.

### Data File

#### DATA FILE N10

Offset	15	14	13	12	11	10	9	8	7	6	5	4	3	2	1	0
N10:0	0	0	0	0	1	1	0	0	0	0	0	0	1	1	0	1

## Supplementary Example

### Application Setup – Display Amps, PSI, and Liquid Level

This example shows how to display current, pressure, and liquid level at one annunciator panel. The motor current draw is displayed in amps. The tank pressure is displayed in psi. The liquid level in the holding tank is displayed in inches.

A three-position selector switch allows the operator to choose between displaying the current draw for L1, L2, or L3 of the three-phase motor. Two warning pilot lights indicate a low or high liquid level condition in the holding tank. Each display is a 3-digit, 7-segment display. The displays have DC-sinking inputs and use BCD data format.

### Device Configuration

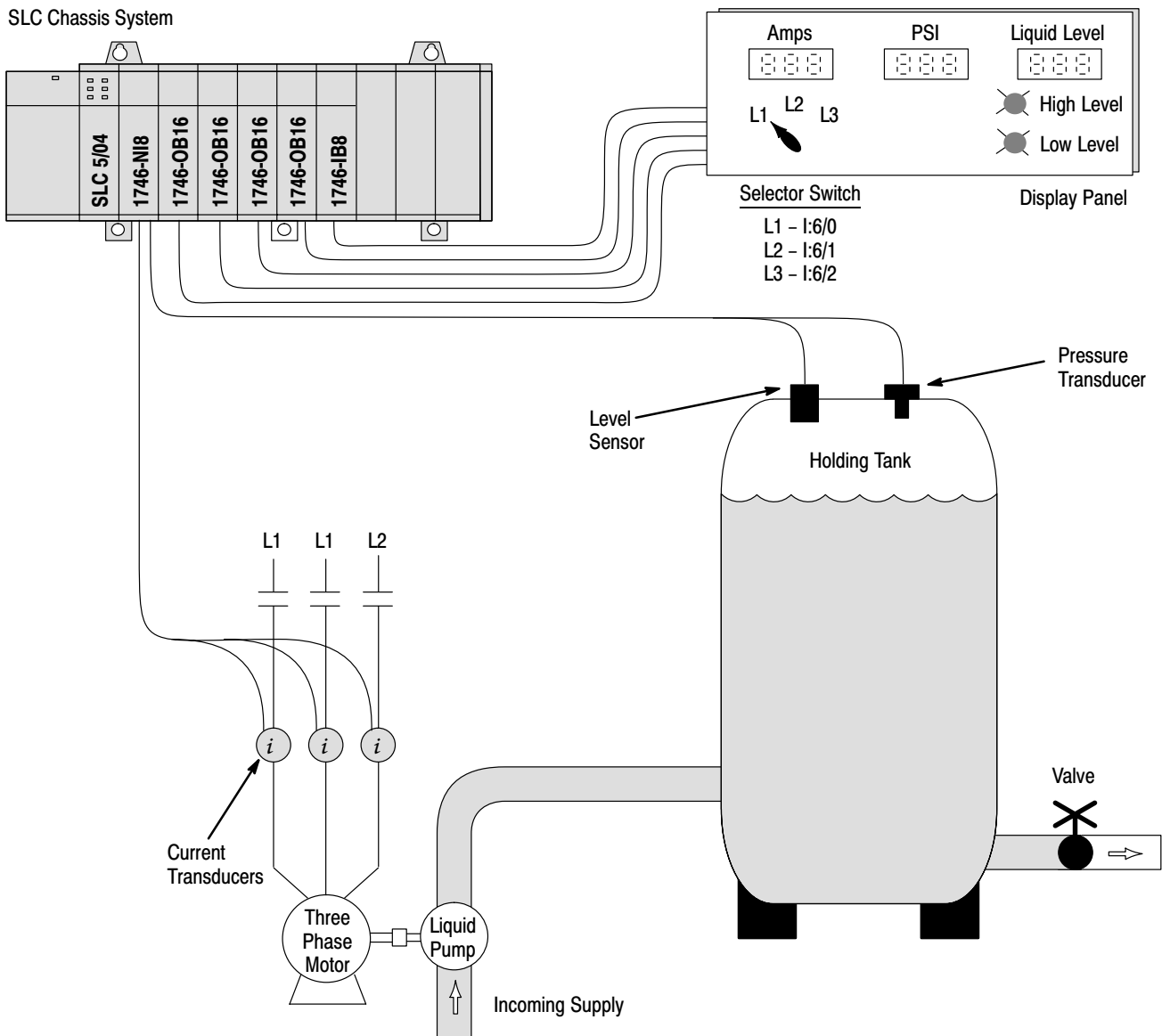

## Channel Configuration

Configuration setup for **current transducers**:

- channels 0, 1, and 2
- 4–20 mA input type
- engineering units data format
- zero data word in the event of an open circuit
- 10 Hz input filter to reject high frequency noise and provide 60 Hz line noise rejection

Configuration setup for **pressure transducer**:

- channel 3
- 4–20 mA input type
- engineering units data format
- zero data word in the event of an open circuit
- 10 Hz input filter to reject high frequency noise and provide 60 Hz line noise rejection

Configuration setup for **level sensor**:

- channel 4
- 0–10V dc input type
- engineering units data format
- zero data word in the event of an open circuit
- 10 Hz input filter to reject high frequency noise and provide 60 Hz line noise rejection

### Channel Configuration Worksheet (With Settings Established for Channels 0-4)

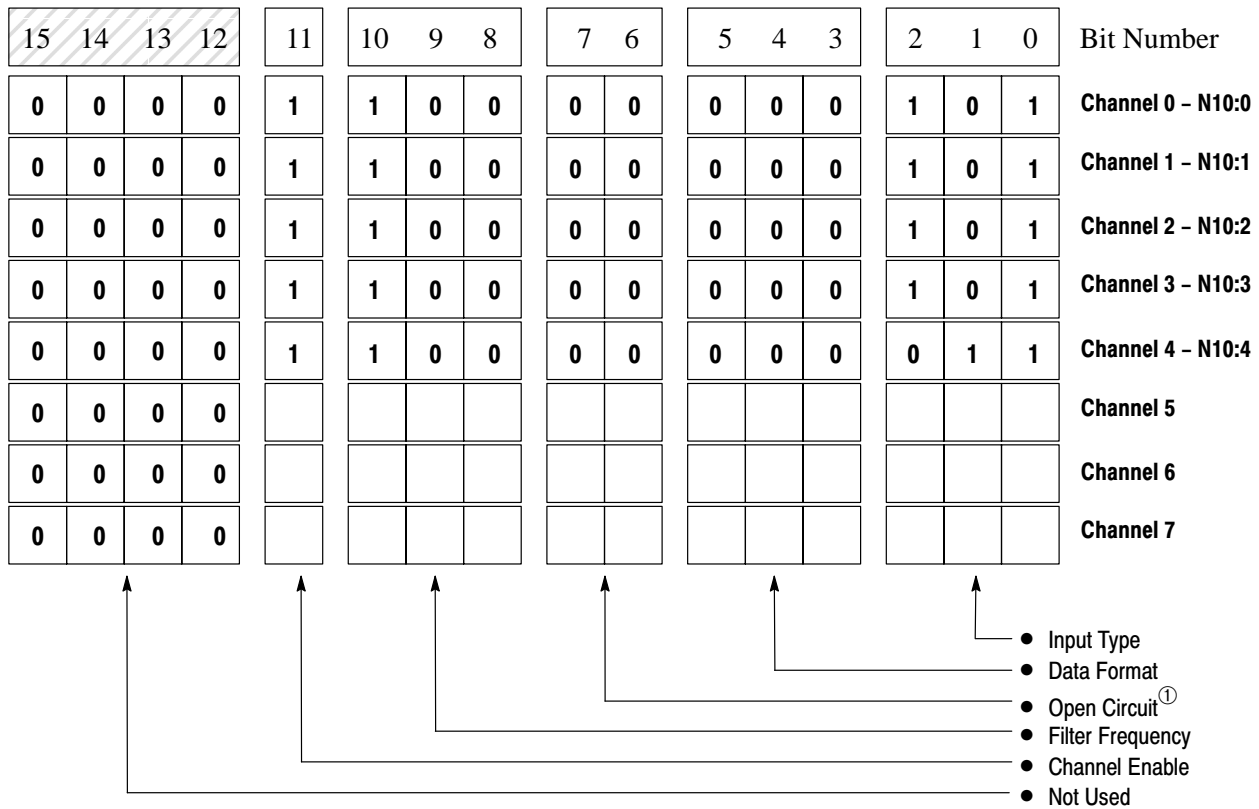

**Bit Definitions:**

Bits	Definition	000	010	100	110
<b>Bits 0-2</b>	Input Type	000 = ±10V dc	010 = 0-5V dc	100 = 0-20 mA	110 = ±20 mA
		001 = 1-5V dc	011 = 0-10V dc	101 = 4-20 mA	111 = 0-1 mA
<b>Bits 3-5</b>	Data Format	000 = engineering units	010 = proportional counts	100 = user defined scaling	110 = illegal
		001 = scaled-for-PID	011 = 1746-NI4 data format	101 = user defined scaling	111 = illegal
<b>Bits 6 and 7</b>	Open Circuit <sup>①</sup>	00 = zero	01 = upscale	10 = downscale	11 = illegal
<b>Bits 8-10</b>	Filter Frequency	000 = no filter	010 = 50 Hz	100 = 10 Hz	110 = 2 Hz
		001 = 75 Hz	011 = 20 Hz	101 = 5 Hz	111 = 1 Hz
<b>Bit 11</b>	Channel Enable	0 = channel disabled		1 = channel enabled	
<b>Bits 12-15</b>	Not Used	0000 = always make this setting			

<sup>①</sup> The open circuit option is only valid for the 4-20 mA data format.

## Program Set Up and Operation Summary

1. Set up one configuration word in memory for each channel. The table below shows the configuration word allocation summary.

Channel	Configuration Word	Value
0	N10:0	L1 (amps)
1	N10:1	L2 (amps)
2	N10:2	L3 (amps)
3	N10:3	pressure (psi)
4	N10:4	liquid level (inches)

2. When the position of the three-position selector changes, convert the appropriate scaled data word to BCD and send the data to the LED display.

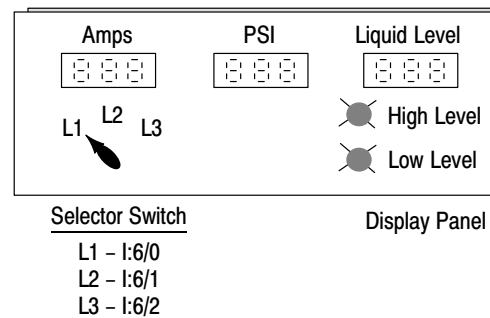

3. If the liquid level goes below the low level set point, turn on the low level warning light, and if the liquid level goes above the high level set point, turn on the high level warning light.
4. Convert the individual analog scaled data words to BCD and send the data to the respective LED displays.



### Program Listing

The first rung of this program sends the channel setup information to the 1746-NI8 module. The next four rungs send the scaled data to the LED display based on the position of the selector switch.

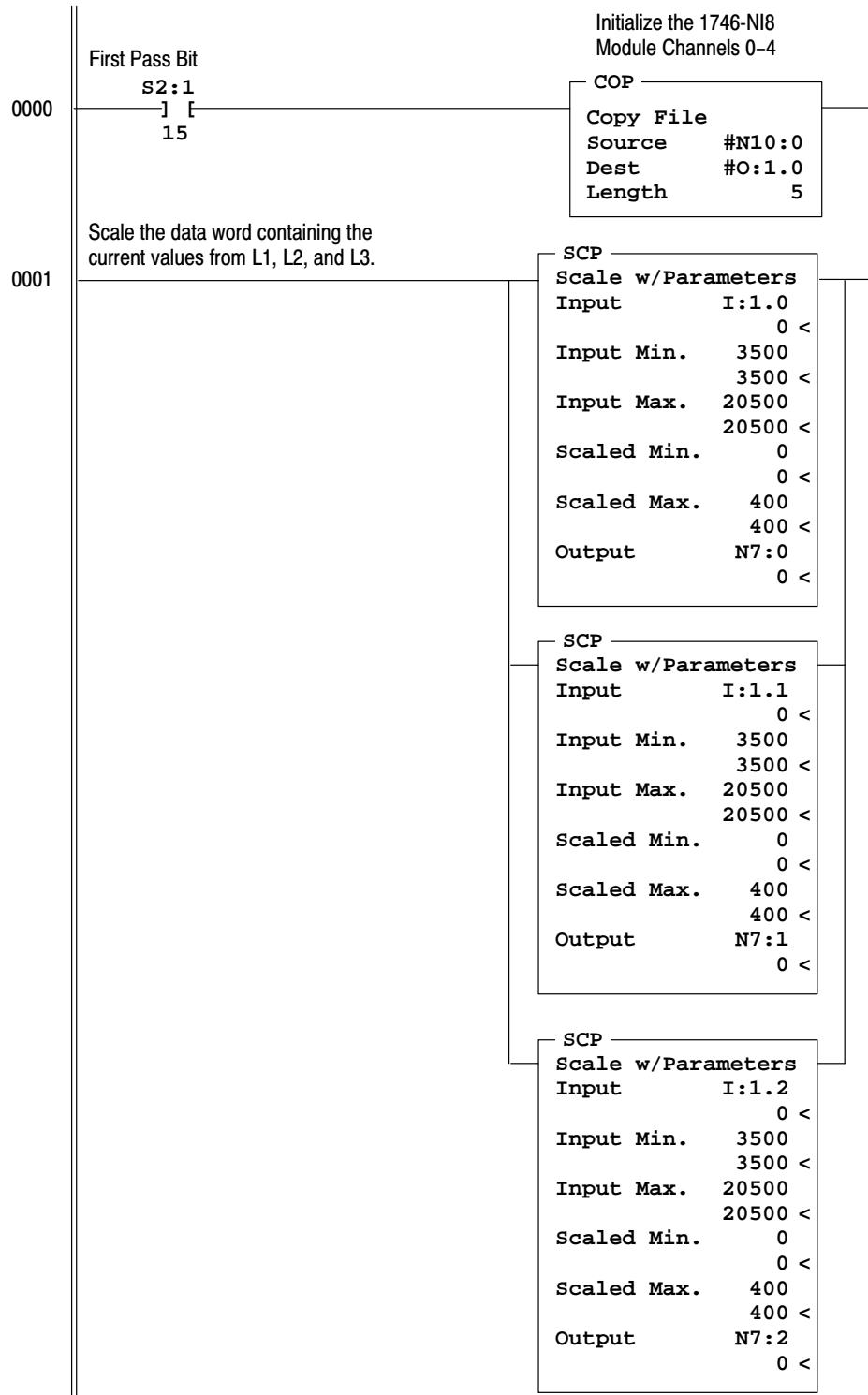

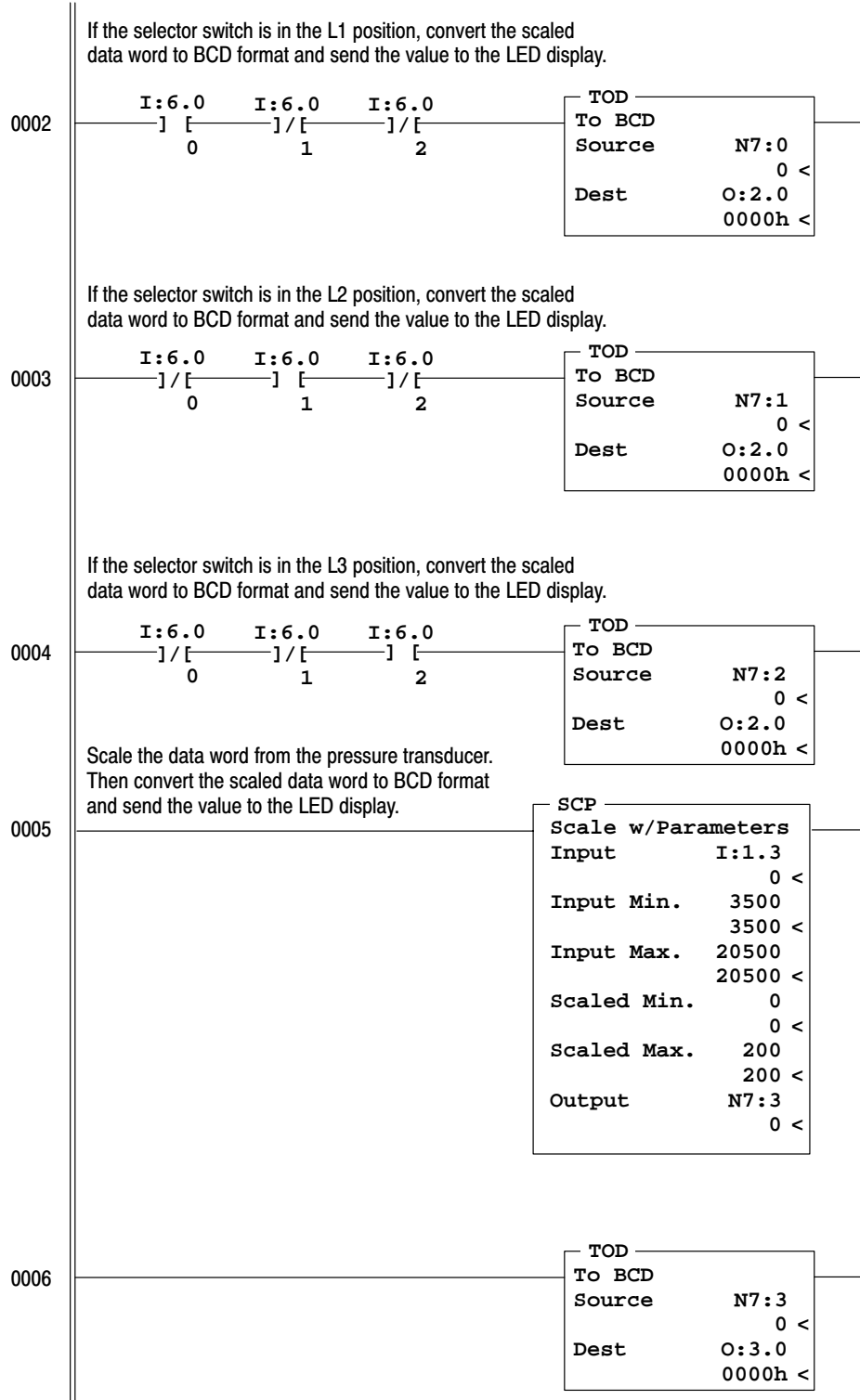

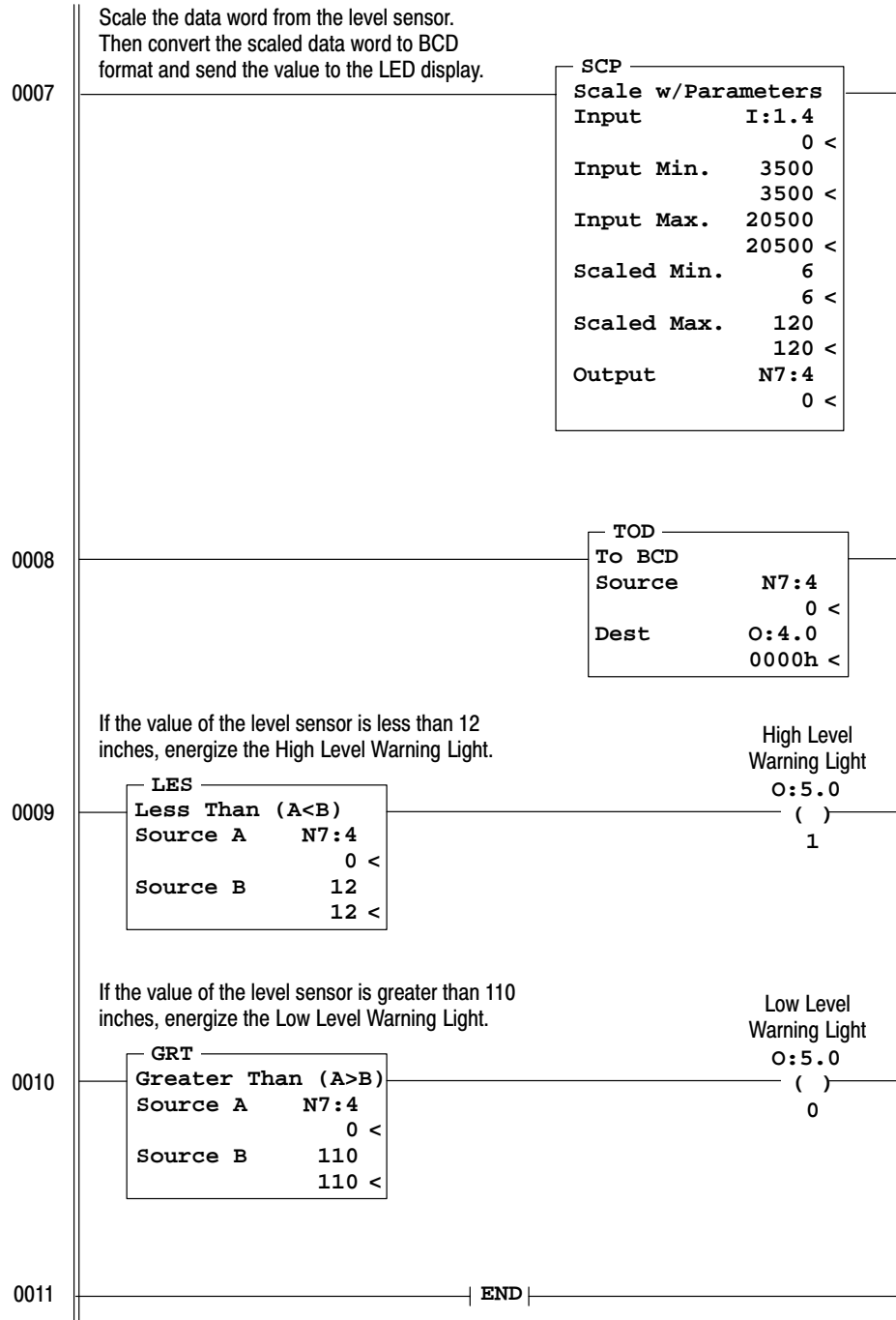

**Data File**

DATA FILE N10

Offset	15	14	13	12	11	10	9	8	7	6	5	4	3	2	1	0
N10:0	0	0	0	0	1	1	0	0	0	0	0	0	0	1	0	1
N10:1	0	0	0	0	1	1	0	0	0	0	0	0	0	1	0	1
N10:2	0	0	0	0	1	1	0	0	0	0	0	0	0	1	0	1
N10:3	0	0	0	0	1	1	0	0	0	0	0	0	0	1	0	1
N10:4	0	0	0	0	1	1	0	0	0	0	0	0	0	0	1	1

## Specifications

This appendix lists the specifications for the 1746-NI8 Analog Input Module.

### Electrical Specifications

Description	Specification
Backplane Current Consumption	200 mA at 5V dc 100 mA at 24V dc
Backplane Power Consumption	3.4W maximum (1.0W @ 5V dc, 2.4W @ 24V dc)
Number of Channels	8 (backplane isolated)
I/O Chassis Location	Any I/O module slot except slot 0
A/D Conversion Method	Successive approximation, switched capacitor
Input Filtering	Low pass digital filter with programmable filter frequencies
Normal Mode Rejection (between [+] input and [-] input)	Provided by low-pass filter
Common Mode Rejection (between inputs and chassis ground)	Greater than or equal to 75 dB at DC Greater than or equal to 100 dB at 50/60 Hz
Input Filter Frequencies	1 Hz 2 Hz 5 Hz 10 Hz 20 Hz 50 Hz 75 Hz
Calibration	The module performs continuous autocalibration.
Isolation	50V dc continuous between the analog inputs and the backplane 530V ac and 750V dc pulse withstand for 1 second
Common-Mode Voltage Range	±10.5V (21V maximum between any two terminals)

### Physical Specifications

Description	Specification
LED Indicators	9 green status indicators one for each of 8 channels and one for module status
Module ID Code	Class 1 Interface: 3526 Class 3 Interface: 12726
Recommended Cable	Belden #8761 or equivalent
Maximum Wire Size	Two 14 AWG wires per terminal
Maximum Cable Impedance	Voltage Source (with less than 10Ω impedance): 40Ω maximum loop impedance, for <1LSB error Current Source (transmitter properly wired to its power supply): 250Ω maximum loop impedance, to meet common-mode voltage requirements
Terminal Block	Removable, Allen-Bradley spare part Catalog Number 1746-RT25G

## Environmental Specifications

Description	Specification
Operating Temperature	0°C to 55°C (32°F to 131°F) in any slot except slot 0 0°C to 60°C (32°F to 140°F) in right most slot of chassis
Storage Temperature	-40°C to +85°C (-40°F to +185°F)
Relative Humidity	5% to 95% (without condensation)
Certification	UL listed CSA approved CE compliant for all applicable directives
Hazardous Environment Classification	Class I Division 2 Hazardous Environment

## Input Specifications

Description	Specification
Type of Input (Selectable)	± 10V dc 1-5V dc 0-5V dc 0-10V dc 0-20 mA 4-20 mA ± 20 mA 0-1 mA
Type of Data (Selectable)	Engineering Units Scaled-for-PID Proportional Counts (-32,768 to +32,767 range) Proportional Counts (User Defined Range, Class 3 only) 1746-NI4 Data Format
Input Impedance	1 MΩ
Voltage Input (maximum)	±30V between any two signal terminals
Current Input (maximum)	±30 mA
Time to Detect Open Circuit	1 module scan
Input Step Response	See Chapter 4, Channel Filter Frequency Selection, page 4-7
Input Resolution	1 mV or 1 μA
Display Resolution	1 mV or 1 μA
Overall Module Accuracy (0°C to 60°C, 32°F to 140°F)	Voltage input types (± 10V dc, 1-5V dc, 0-5V dc, 0-10V dc): ±0.1% Current input types (0-20 mA, 4-20 mA, ± 20 mA): ±0.05% Current input type (0-1 mA): ±0.5%
Overall Module Drift	Voltage input type: ±6 ppm/°C Current input type: ±12 ppm/°C
Module Update Time	See Chapter 4, Update Time, page 4-5
Channel Turn-On Time	See Chapter 4, Turn-On Time, page 4-6
Channel Turn-Off Time	See Chapter 4, Turn-Off Time, page 4-6
Channel Reconfiguration Time	See Chapter 4, Reconfiguration Time, page 4-6

## Configuration Worksheet

The following worksheet is provided to help you configure each of the channels on your module. See Chapter 5 for detailed configuration information.

15 14 13 12				11	10 9 8			7 6		5 4 3			2 1 0			Bit Number
0	0	0	0													<b>Channel 0</b>
0	0	0	0													<b>Channel 1</b>
0	0	0	0													<b>Channel 2</b>
0	0	0	0													<b>Channel 3</b>
0	0	0	0													<b>Channel 4</b>
0	0	0	0													<b>Channel 5</b>
0	0	0	0													<b>Channel 6</b>
0	0	0	0													<b>Channel 7</b>

- Input Type
- Data Format
- Open Circuit
- Filter Frequency
- Channel Enable
- Not Used

**Bit Definitions:**

Bits	Function	000	010	100	110
<b>Bits 0-2</b>	Input Type	000 = ±10V dc	010 = 0-5V dc	100 = 0-20 mA	110 = ±20 mA
		001 = 1-5V dc	011 = 0-10V dc	101 = 4-20 mA	111 = 0-1 mA
<b>Bits 3-5</b>	Data Format	000 = engineering units	010 = proportional counts	100 = user defined scaling	110 = illegal
		001 = scaled-for-PID	011 = 1746-NI4 data format	101 = user defined scaling	111 = illegal
<b>Bits 6 and 7</b>	Open Circuit	00 = zero	01 = upscale	10 = downscale	11 = illegal
<b>Bits 8-10</b>	Filter Frequency	000 = no filter	010 = 50 Hz	100 = 10 Hz	110 = 2 Hz
		001 = 75 Hz	011 = 20 Hz	101 = 5 Hz	111 = 1 Hz
<b>Bit 11</b>	Channel Enable	0 = channel disabled			1 = channel enabled
<b>Bits 12-15</b>	Not Used	0000 = always make this setting			

## Converting from 1746-NI4 to 1746-NI8

This information is provided for those who are replacing two 1746-NI4 modules with one 1746-NI8 module.

### Module ID Code

The module identification code is a unique number encoded for each 1746 I/O module. The code defines for the processor the type of I/O or specialty module residing in a specific slot in the 1746 chassis.

Using your programming device, configure the slot with the appropriate ID code. In this example, the 1746-NI8 is in slot 3.

Catalog Number	ID Code
1746-NI8	3526 – Class 1 interface 12726 – Class 3 interface

**Important:** All programming software does not support configuration for Class 3 operation.

- Advanced Programming Software (APS) supports Class 3 configuration. After entering the ID code (12726), enter 16 input words and 12 output words.
- SLC 500 A.I. Series™ Programming Software supports Class 3 configuration. After entering the ID code (12726), enter 16 input words and 12 output words.
- RSLogix 500™, version 1.30 or later, supports Class 3 configuration. After entering the ID code (12726), select Class 3 operation.
- Earlier versions of RSLogix 500 will only support configuration for Class 1 operation. Contact Rockwell Software for information on upgrading your software.

See chapter 4 for more information on Class 1 and Class 3 interfaces.

## Addressing

Addressing is changed from two modules with 4 channels to one module with 8 channels. The input addressing is shown below.

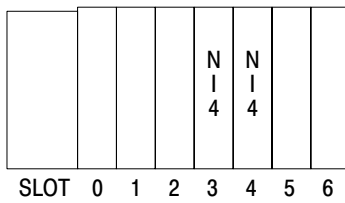

### 1746-NI4 Input Addressing

- I:3.0 – Slot 3, Channel 0 Data Word
- I:3.1 – Slot 3, Channel 1 Data Word
- I:3.2 – Slot 3, Channel 2 Data Word
- I:3.3 – Slot 3, Channel 3 Data Word
- I:4.0 – Slot 4, Channel 0 Data Word
- I:4.1 – Slot 4, Channel 1 Data Word
- I:4.2 – Slot 4, Channel 2 Data Word
- I:4.3 – Slot 4, Channel 3 Data Word

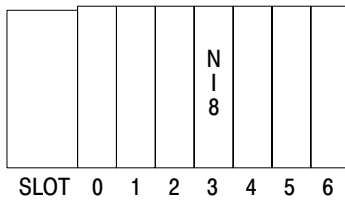

### 1746-NI8 Input Addressing

- I:3.0 – Slot 3, Channel 0 Data Word
- I:3.1 – Slot 3, Channel 1 Data Word
- I:3.2 – Slot 3, Channel 2 Data Word
- I:3.3 – Slot 3, Channel 3 Data Word
- I:3.4 – Slot 3, Channel 4 Data Word
- I:3.5 – Slot 3, Channel 5 Data Word
- I:3.6 – Slot 3, Channel 6 Data Word
- I:3.7 – Slot 3, Channel 7 Data Word



## Channel Configuration

For the 1746-NI4, input selection (voltage or current) is made via a switch. For the 1746-NI8, input selection (voltage or current) is made via a switch and a configuration word is used to define the other operating parameters for the module. The 1746-NI4 does not employ a configuration word.

To configure the 1746-NI8 for the same input type as the 1746-NI4, use the following configuration word. For voltage input you must select  $\pm 10\text{V}$  dc, and for current input you must select  $\pm 20$  mA. Define a configuration word for channels 0–7 on the 1746-NI8 module.

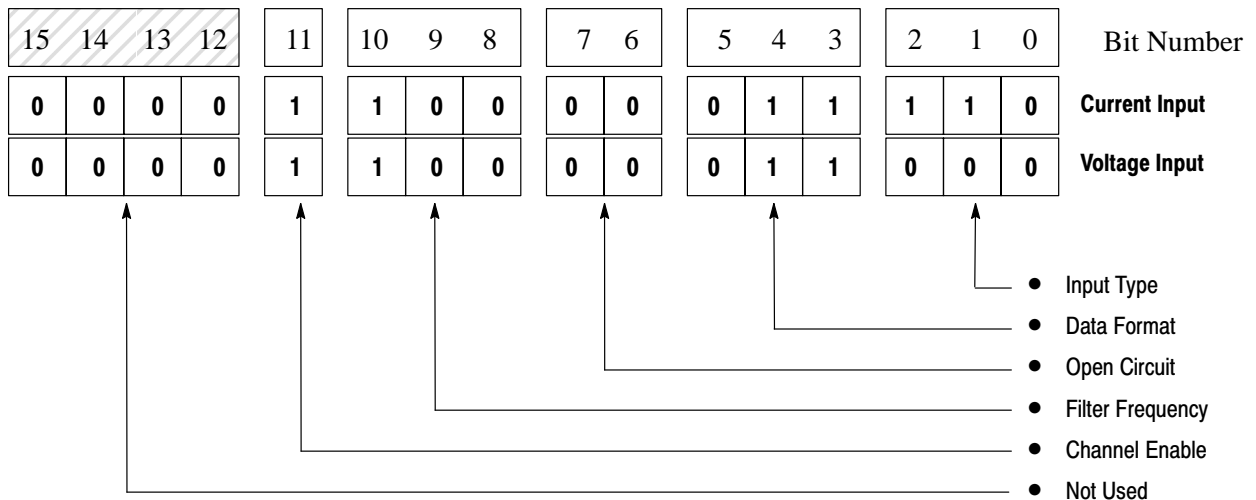

### Bit Definitions for Converting from 1746-NI4 to 1746-NI8:

Bits	Definition	Values
Bits 0–2	Input Type	000 = $\pm 10\text{V}$ dc    110 = $\pm 20$ mA
Bits 3–5	Data Format	011 = 1746-NI4 data format
Bits 6 and 7	Open Circuit	00 = zero (the open circuit option is not available for the $\pm 20$ mA data type)
Bits 8–10	Filter Frequency	100 = 10 Hz
Bit 11	Channel Enable	0 = channel disabled    1 = channel enabled
Bits 12–15	Not Used	0000 = always make this setting

See chapter 5 for more detailed information on channel configuration.

## Ladder Program

To convert your ladder program from the 1746-NI4s to a 1746-NI8, you only need to change the module addressing. Change the addresses in the program (slot and word sub element number) to reflect the location of the new module.

See chapter 6 for more information on ladder programming.

## Two's Complement Binary Numbers

The SLC 500 processor memory stores 16-bit binary numbers. Two's complement binary is used when performing mathematical calculations internal to the processor. Analog input values from the analog modules are returned to the processor in 16-bit two's complement binary format. For positive numbers, the binary notation and two's complement binary notation are identical.

As indicated in the figure on the next page, each position in the number has a decimal value, beginning at the right with  $2^0$  and ending at the left with  $2^{15}$ . Each position can be 0 or 1 in the processor memory. A 0 indicates a value of 0; a 1 indicates the decimal value of the position. The equivalent decimal value of the binary number is the sum of the position values.

### Positive Decimal Values

The far left position is always 0 for positive values. As indicated in the figure below, this limits the maximum positive decimal value to 32767 (all positions are 1 except the far left position). For example:

$$0000\ 1001\ 0000\ 1110 = 2^{11} + 2^8 + 2^3 + 2^2 + 2^1 = 2048 + 256 + 8 + 4 + 2 = 2318$$

$$0010\ 0011\ 0010\ 1000 = 2^{13} + 2^9 + 2^8 + 2^5 + 2^3 = 8192 + 512 + 256 + 32 + 8 = 9000$$

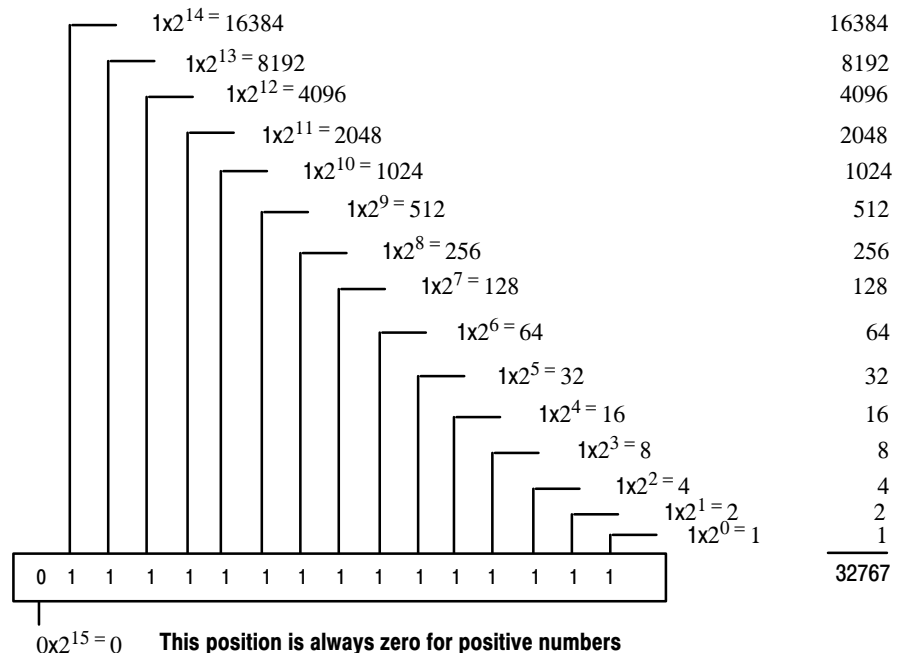

### Negative Decimal Values

In two's complement notation, the far left position is always 1 for negative values. The equivalent decimal value of the binary number is obtained by subtracting the value of the far left position, 32768, from the sum of the values of the other positions. In the figure below (all positions are 1), the value is  $32767 - 32768 = -1$ . For example:

$$1111\ 1000\ 0010\ 0011 =$$

$$(2^{14} + 2^{13} + 2^{12} + 2^{11} + 2^5 + 2^1 + 2^0) - 2^{15} =$$

$$(16384 + 8192 + 4096 + 2048 + 32 + 2 + 1) - 32768 =$$

$$30755 - 32768 = -2013.$$

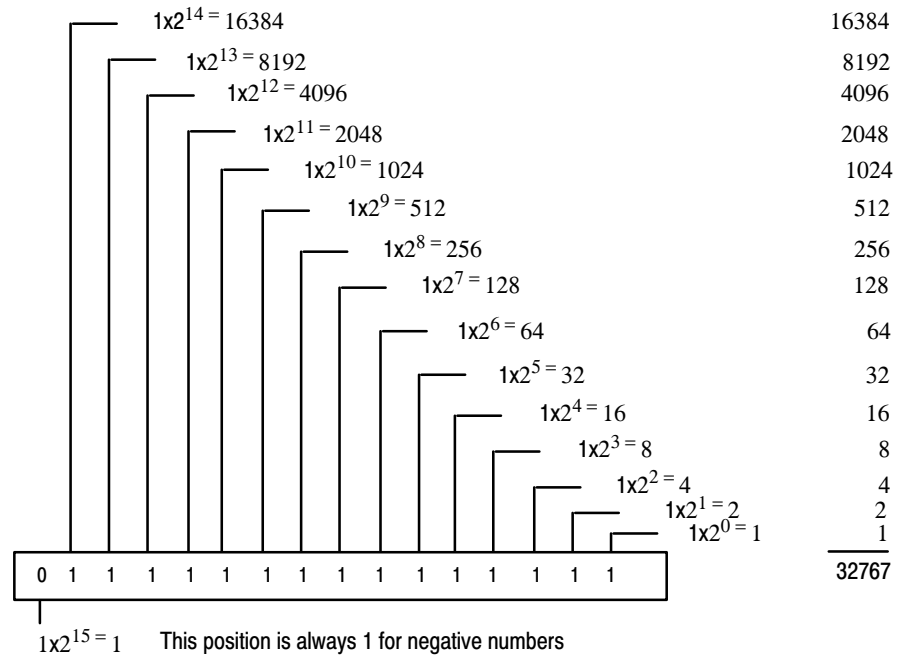

---

# Glossary

The following terms and abbreviations are used throughout this manual. For definitions of terms not listed here refer to *Allen-Bradley's Industrial Automation Glossary*, Publication AG-7.1.

**A/D** - Refers to the analog to digital converter inherent to the module. The converter produces a digital value whose magnitude is proportional to the instantaneous magnitude of an analog input signal.

**analog input module** - An I/O module that contains circuits that convert analog dc input signals to digital values that can be manipulated by the processor.

**attenuation** - The reduction in the magnitude of a signal as it passes through a system.

**backplane** - A printed circuit board, at the back of the chassis, that provides electrical interconnection between the modules inserted into the chassis.

**channel** - Refers to one of eight, small-signal analog input interfaces available on the module's terminal block. Each channel is configured for connection to a voltage or current source input device, and has its own data and diagnostic status words.

**channel update time** - The time required for the module to sample and convert the input signals of one enabled input channel and update the channel data word.

**chassis** - A hardware assembly that houses devices such as I/O modules, adapter modules, processor modules, and power supplies.

**common mode rejection ratio** - The ratio of a device's differential voltage gain to common mode voltage gain. Expressed in dB, CMRR is a comparative measure of a device's ability to reject interference caused by a voltage common to its input terminals relative to ground.  $CMRR = 20 \text{ Log}_{10} (V_1/V_2)$

**common mode voltage** - A voltage that appears in common at both input terminals of a differential analog input with respect to ground.

**configuration word** - Contains the channel configuration information needed by the module to configure and operate each channel. Information is written to the configuration word through the logic supplied in your ladder program.

**dB** - (decibel) A logarithmic measure of the ratio of two signal levels.

**data word** - A 16-bit integer that represents the value of the analog input channel. The channel data word is valid only when the channel is enabled and there are no channel errors. When the channel is disabled the channel data word is cleared (0).

**digital filter** - A filter implemented in firmware, using discrete, sampled data of the input signal.

**filter** - A device that passes a signal or range of signals and eliminates all others.

**filter frequency** - (-3 dB frequency) The user-selectable frequency.

**full scale error** - (gain error) The difference in slope between the actual and ideal analog transfer functions.

**full scale range** - (FSR) The difference between the maximum and minimum specified analog input values.

**gain drift** - The change in full scale transition voltage measured over the operating temperature range of the module.

**input data scaling** - The data formats that you select to define the logical increments of the channel data word. These may be scaled-for-PID, or Engineering Units, which are automatically scaled. They may also be proportional counts, which you must calculate to fit the resolution of the quantity being measured in your application.

**input image** - The input from the 1746-NI8 module to the SLC processor. The input image contains the module data words and status words.

**local configuration** - A control system where all the chassis are located within several feet of the processor, and chassis-to-chassis communication is via a 1746-C7 or 1746-C9 ribbon cable.

**LSB** - (Least Significant Bit) The bit that represents the smallest value within a string of bits.

**module scan time** - same as *module update time*

**module update time** - The time required for the module to sample and convert the input signals of all enabled input channels and make the resulting data values available to the SLC™ processor.

**multiplexer** - An switching system that allows several input signals to share a common A/D converter.

**normal mode rejection** - (differential mode rejection) A logarithmic measure, in dB, of a device's ability to reject noise signals between or among circuit signal conductors.

**output image** - The output from the SLC processor to the 1746-NI8 module. The output image contains the module configuration information. Each output word configures a single channel.

**remote configuration** - A control system where the chassis can be located several thousand feet from the processor chassis. Chassis communication is via the 1747-SN Scanner and 1747-ASB Remote I/O Adapter.

**resolution** - The smallest detectable change in a measurement, typically expressed in engineering units (e.g. 1 mV) or as a number of bits. For example a 12-bit system has 4,096 possible output states. It can therefore measure 1 part in 4096.

**scaling** - The process of changing a quantity from one notation to another.

**status word** - Contains status information about the channel's current configuration and operational state. You can use this information in your ladder program to determine whether the channel data word is valid.

**step response time** - This is the time required for the channel data word signal to reach a specified percentage of its expected final value, given a large step change in the input signal.

**transducer** - A device that converts one energy form to another (e.g., mechanical to electrical). When a transducer is actuated by signals from one system or medium, it can supply a related signal to the other system or medium.

## Symbols

-3 dB frequency. See filter frequency

## A

### A/D

converter, 1-4  
definition, G-1  
value in data word, 5-3

abbreviations, G-1

addressing, 4-2

1746-NI4 to 1746-NI8, C-2  
configuration word, 4-3  
addressing example, 4-4  
data word, 4-4  
addressing example, 4-4  
status word, 4-4  
addressing example, 4-4

alarms, 6-4

aliasing frequency, 4-8

Allen-Bradley, P-4

contacting for assistance, P-4

analog input module

definition, G-1  
overview, 1-1

attenuation

-3 dB frequency, 4-7  
definition, G-1

## B

backplane

connector, 3-5  
data transfer, 1-4  
definition, G-1  
electrostatic damage, 3-1  
ground connection, 2-3, 3-7  
interface, 1-3  
power supply, 3-1

bit allocation, 5-1

in status word, 5-12

bit definition

channel enable, 5-4  
channel status, 5-13  
configuration error, 5-14  
data format, 5-3, 5-13  
filter frequency, 5-4, 5-13  
in configuration word, 5-2

in status word, 5-12

input type, 5-3, 5-13

open circuit error, 5-14

open circuit state, 5-3, 5-13

over-range error, 5-14

under-range error, 5-14

## C

cable tie slots, 1-2

calibration, 1-4

channel, definition, G-1

channel configuration error, 7-3

fault detection bit, 5-14

channel filter frequency, 4-7

effects on noise filtering, 4-7

effects on update time, 4-7

channel status bit, 5-13

channel status LED, 1-3, 2-6

channel status word, example, 2-7

channel step response, 4-7

channel update time, definition, G-1

chassis

definition, G-1  
installing module in, 3-5  
installing module in, 2-3

CMRR. See common mode rejection ratio

common mode rejection ratio, definition, G-1

common mode voltage, definition, G-1

configuration word, 4-3

bit definition chart, 5-2

definition, G-1

factory default setting, 5-1

worksheet, B-1

configuring a channel, 5-1

worksheet, B-1

connection diagram, 2-3, 3-6

contacting Allen-Bradley for assistance, P-4

contents of manual, P-2

converting from 1746-NI4 to 1746-NI8, C-1

current draw, 3-1

cut-off frequency, 4-7

**D**

data type descriptions, 5-6

data word, 4-4

- addressing, 4-4
- converting to other units, 5-6
- definition, G-2
- module input image, 2-6, 5-5
- scaling examples, 5-8
- values for engineering units, 5-5
- values for scaled data, 5-6

data word format, 5-3

- examining in status word, 5-13
- setting in configuration word, 5-3

dB, definition, G-2

decibel. *See* dB

default setting of configuration word, 5-1

definition of terms, G-1

diagnostics

- at power-up, 7-1
- channel diagnostics, 7-1

differential mode rejection. *See* normal mode rejection

digital filter, definition, G-2

DIP switches, 1-2, 2-2

disabling a channel, 5-4

door label, 1-2

**E**

electrical noise, 3-3, 3-9

electrical specifications, A-1

electrostatic damage, 3-1

EMC Directive, 3-3

enabling a channel, 5-4

engineering units input, 5-6

environmental specifications, A-2

equipment required for installation, 2-1

errors, 7-3

- channel-related errors, configuration error, 7-3
- detecting channel-related errors, 7-3
  - open circuit, 7-3
  - over-range error, 7-3
  - under-range error, 7-3
- module-related errors, 7-4
  - conditions at power-up, 7-4
  - over-range error, 7-3

European Union Directives, 3-3

configuration word, 2-4

**examples**

- basic application example, 8-1
- how to address configuration word, 4-4
- how to address data word, 4-4
- how to address status word, 4-4
- how to use PID instruction, 6-3
- scaling the data word, 5-8
- supplementary application example, 8-4
- using alarms to indicate status, 6-4

**F**

fault condition

- at power-up, 1-3
- during operation, 1-3

filter, definition, G-2

filter frequency, 4-7

- definition, G-2
- examining in status word, 5-13
- setting in configuration word, 5-4

FSR. *See* full scale range

full scale error, definition, G-2

full scale range, definition, G-2

**G**

gain drift, definition, G-2

gain error. *See* full scale error

getting started, 2-1

- procedure, 2-2
- tools required, 2-1

**H**

hazardous environment classification, A-2

heat considerations, 3-3

**I**

ID code, 4-1, C-1

input channel multiplexing, 1-4

input data scaling, definition, G-2

input device type, 5-3

- examining in status word, 5-13
- setting in configuration word, 5-3

input devices

- source impedance, 3-9
- wiring, 3-9

input filter. *See* filter frequency



input image, 2-6  
    *See also* status word and data word  
    definition, G-2

input response to slot disabling, 4-6

input specifications, A-2

input types, A-2

installation, 3-1, 3-5  
    equipment required, 2-1  
    getting started, 2-1  
    heat and noise considerations, 3-3  
    location in chassis, 2-3, 3-2

## L

LEDs, 1-2  
    channel status indicators, 1-2  
    module status indicator, 1-2  
    state tables, 7-2

local configuration, definition, G-2

LSB, 5-6  
    definition, G-2

## M

memory map, 4-2, 4-3

module ID code, 2-4, 4-1, C-1  
    how to enter, 2-4, 4-1, C-1

module operation, 1-4

module scan time  
    definition, G-2  
    minimizing, 5-4  
    response to open circuit, 5-4

module status LED, 2-6

module update time  
    calculating, 4-5  
    definition, G-2  
    for number of channels enabled, 4-5  
    increased by reconfiguration, 5-4

multiplexer, definition, G-2

multiplexing, 1-4

## N

negative decimal values, D-2

noise filtering, 4-7

normal mode rejection, definition, G-3

## O

open-circuit, 7-3  
    defining conditional state of channel data,  
        5-3  
        downscale enable, 5-3  
        upscale enable, 5-3  
        zero, 5-3  
    error condition, 7-3  
        fault detection bit, 5-14  
    module response to, 5-4, 5-13

operation  
    module, 1-4  
    system, 1-3

out-of-range error, 7-3  
    over-range error, 5-14  
    under-range error, 5-14

output image, 2-5, 4-3  
    definition, G-3

output response to slot disabling, 4-6

over-range error, 5-14  
    fault indicator bit, 5-14

## P

physical specifications, A-1

PID input type, 5-6

PID instruction, 6-3

pinout diagram, 3-6

Positive Decimal Values, D-1

power requirements, 3-1

power-up sequence, 1-3

programming  
    alarms, 6-4  
    configuration settings, 2-5, 6-1  
    initial setting, 6-1  
    PID instruction, 6-3

proportional counts input, 5-6

## R

reconfiguration time, 4-6

remote configuration, definition, G-3

removable terminal block, 1-2

removing the module, 3-4

resolution, definition, G-3

**S**

scaled-for-PID, 5-6

scaling, definition, G-3

scaling input data. *See* input data scaling

scan time, G-2

self-locking tabs, 1-2

shield connections, 3-6, 3-9

slot disabling, 4-6

software, 2-4, 4-1, C-1

specifications, A-1

- electrical, A-1
- environmental, A-2
- input, A-2
- physical, A-1

start-up instructions, 2-1

status bit

- channel enable, 1-3
- fault condition, 1-3
- time to reset, 4-6
- time to set, 4-6

status LED. *See* channel status LED or module status LED

status word

*See also* input image

- addressing, 4-4
- bit definition chart, 5-12
- definition, G-3
- module input image, 5-11

step response time

- at filter frequency, 4-7
- definition, G-3
- in choosing filter frequency, 5-4

system operation, 1-3

**T**

terminal pinout diagram, 3-6

terminal wiring, 3-6

- wiring inputs, 3-10

tools required for installation, 2-1

transducer

- definition, G-3
- source impedance, 3-9
- wiring, 3-10

troubleshooting

- contacting Allen-Bradley, P-4
- flowchart, 7-5
- LED examination, 7-2

turn-off time, 4-6

turn-on time, 4-6

two's complement binary numbers, D-1

**U**

under-range error, 5-14

- fault bit, 5-14

update time, 4-5

*See also* channel update time; module update time

- effects of filter time setting, 4-7
- related to cut-off frequency, 4-8

**W**

wiring, 3-1

- routing considerations, 3-3
- terminal wiring, 3-6
- shield connections, 3-9

worksheet, B-1



Allen-Bradley, a Rockwell Automation Business, has been helping its customers improve productivity and quality for more than 90 years. We design, manufacture and support a broad range of automation products worldwide. They include logic processors, power and motion control devices, operator interfaces, sensors and a variety of software. Rockwell is one of the world's leading technology companies.



## Worldwide representation.

Argentina • Australia • Austria • Bahrain • Belgium • Brazil • Bulgaria • Canada • Chile • China, PRC • Colombia • Costa Rica • Croatia • Cyprus • Czech Republic • Denmark • Ecuador • Egypt • El Salvador • Finland • France • Germany • Greece • Guatemala • Honduras • Hong Kong • Hungary • Iceland • India • Indonesia • Ireland • Israel • Italy • Jamaica • Japan • Jordan • Korea • Kuwait • Lebanon • Malaysia • Mexico • Netherlands • New Zealand • Norway • Pakistan • Peru • Philippines • Poland • Portugal • Puerto Rico • Qatar • Romania • Russia-CIS • Saudi Arabia • Singapore • Slovakia • Slovenia • South Africa, Republic • Spain • Sweden • Switzerland • Taiwan • Thailand • Turkey • United Arab Emirates • United Kingdom • United States • Uruguay • Venezuela • Yugoslavia

Allen-Bradley Headquarters, 1201 South Second Street, Milwaukee, WI 53204 USA, Tel: (1) 414 382-2000 Fax: (1) 414 382-4444