



**Allen-Bradley**

*Technical Data*

## SLC 500™ Modular Chassis and Power Supplies

Chassis Catalog Numbers 1746-A4, -A7, -A10 and  
-A13

Power Supply Catalog Numbers 1746-P1, -P2, -P3,  
-P4, -P5, -P6 and -P7

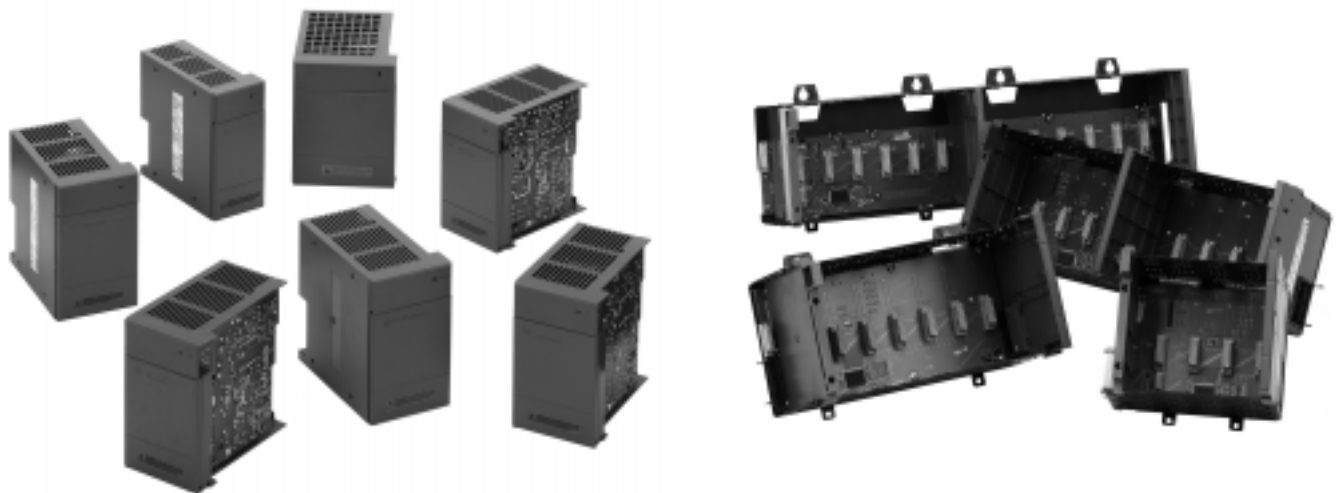

SLC 500 modular chassis and power supplies provide flexibility in system configuration. By selecting the appropriate chassis, power supply, processor, and I/O modules you can create a controller system specifically designed for your application.

Four chassis sizes are available to suit your application needs. Choose from 4-slot, 7-slot, 10-slot, and 13-slot chassis based on your modular hardware component requirements.

Seven power supplies are available to meet your system power requirements. There are three different ac power supplies and four dc power supplies.

## Table of Contents

Hardware Overview .....	3
System Layout Recommendations .....	6
Heat Dissipation.....	8
Dimension Drawings.....	12
Reference Table and Graphs.....	14
Power Supply Specifications.....	18
Allen-Bradley Support .....	21
Worksheets .....	22

## Features and Benefits

### Chassis

The SLC 1746 modular chassis houses the processor and the I/O modules. Features and benefits of the modular chassis series include:

Modules easily slide into chassis slots. No tools are required for module installation.

Up to three chassis can be interconnected. Locally, the processor can address up to 30 slots.

Four chassis sizes are available from which to choose. Selection can be suited to your system I/O requirements.

### Power Supplies

Each chassis requires a power supply to provide power to the processor and each I/O slot. You should consider future system expansion when selecting a power supply. Power supply features and benefits include:

All power supplies have an LED that indicates proper supply power. Monitoring this LED can tell you at a glance whether your supply is operating properly.

Supplies have a hold-up time (the time the system is operational during a brief power loss) typically between 20 milliseconds and 3 seconds. This eliminates nuisance-type shutdowns due to momentary power interruptions.

On ac power supplies, you can select either 120V or 240V operation by setting a jumper. No special wiring is required.

This technical data supplies you with information you need to consider when setting up your control application. It provides specifications and dimension drawings for the SLC 1746 modular chassis and power supplies. It also provides worksheets that you can use to calculate the power supply best suited to your application and the amount of heat you can expect the components in your system to generate under normal operating conditions.

## Hardware Overview

## Chassis Sizes

SLC modular chassis are available in the following slot sizes:

Description	Catalog Number	See Page
4-slot chassis	1746-A4	12
7-slot chassis	1746-A7	12
10-slot chassis	1746-A10	13
13-slot chassis	1746-A13	13

## Chassis Interconnect Cables

You can connect up to three chassis using chassis interconnect cables. Chassis do not include interconnect cables. Below is a description of available cables:

Description	Catalog Number
152.4 mm (6 in.) Chassis Interconnect Cable - Use this ribbon cable when linking modular chassis up to 152.4 mm (6 in.) apart in an enclosure.	1746-C7
914.4 mm (36 in.) Chassis Interconnect Cable - Use this cable when linking modular chassis from 152.4 mm (6 in.) up to 914.4 mm (36 in.) apart in an enclosure.	1746-C9
1270.0 mm (50 in.) Chassis Interconnect Cable - Use this cable when linking modular chassis from 914.4 mm (36 in.) up to 1270.0 mm (50 in.) apart in an enclosure	1746-C16

### *Chassis Interconnect Cable Installation*

Cables must exit the right side of the first chassis and enter the left side of the second chassis. Cables are keyed for proper installation.

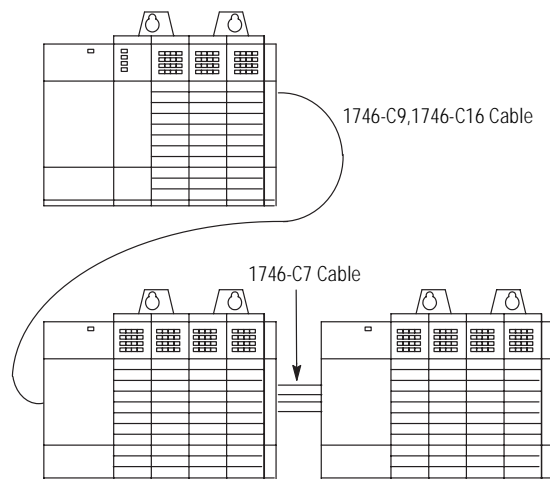

The 1746-C16 cable should be used when connecting two 1746-A13 chassis (one above the other) with 1746-P4 power supplies.

## Power Supply Selection and Installation

When configuring a modular system, you must have an individual power supply for each chassis. The power supply provides power to the processor and each I/O card. Careful system configuration results in the best performance. Excessive loading of the power supply can cause reduced power supply life or a power supply shutdown. The following pages can help you select the power supply best suited for each chassis in your modular SLC control system.

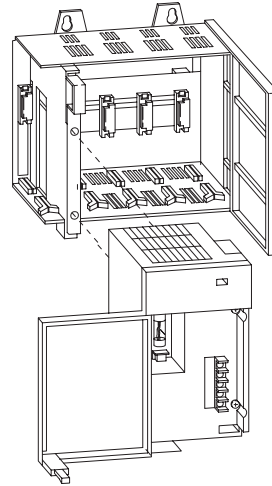

### NOTE

The power supply does not occupy a slot in the chassis. It mounts on the left side with two screws.

## Wiring, Input Voltage Selection and Fuse Location

The power supply terminals accept two #14 AWG wires and are marked as shown in the figures on the following page. On ac power supplies, a jumper is provided to make the 120/240V selection. Place the jumper to match the input voltage. Note that the jumper location on the 1746-P4 supply is different from the jumper location on the P1 and P2 power supplies.

Fuse placement for 1746-P1, P2, and P3 supplies is also shown on the next page. Refer to the *Power Supply Specification* table on page 18 for fuse replacement information. Note that the 1746-P4, -P5, -P6 and -P7 power supplies fuse is non-replaceable.

### ATTENTION



Make jumper selection before applying power. Hazardous voltage is present on exposed pins when power is applied.

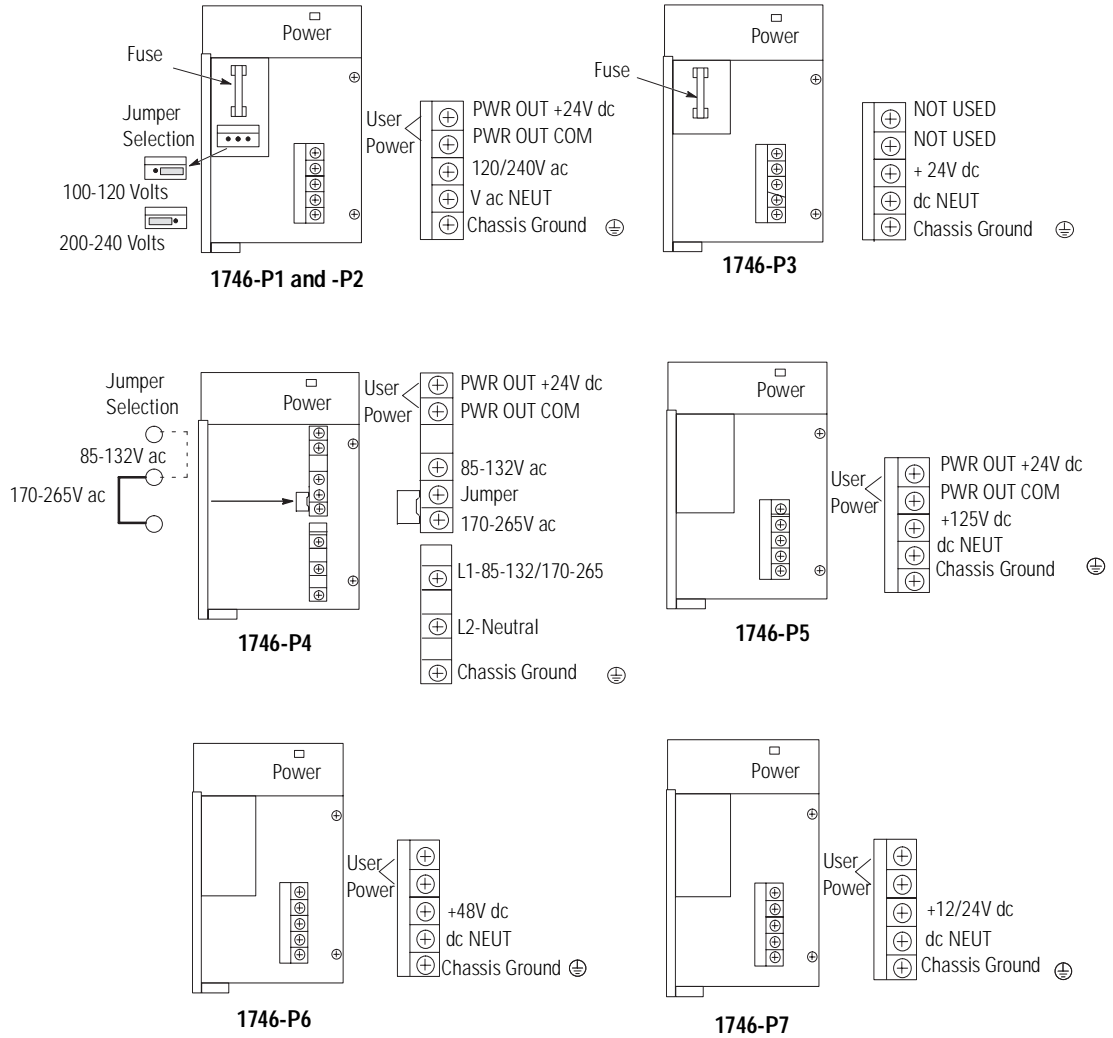

### Power Supply Undervoltage Operation

SLC 500 controllers continue to operate (hold-up) for a short period of time if the input voltage to the power supply drops below the recommended operating voltage range. The controller continues to scan the user program and control I/O during this time.

SLC 500 controllers turn OFF (stop scanning and disable outputs) if input voltage to the power supply is removed or drops below the recommended operating range for a period exceeding the CPU hold-up time. The controller resumes operation automatically when the input voltage is restored to normal.

If the input voltage to the 1746-P7 power supply falls into a range of 4 to 9V for a period exceeding the CPU hold-up time, the controller turns OFF and will not turn back ON until:

- input voltage is increased to 11V dc.
- power is cycled and the input voltage returns to a valid range.

## System Layout Recommendations

## Selecting Enclosures

The enclosure protects the equipment from atmospheric contamination. Standards established by the National Electrical Manufacturer's Association (NEMA) and International Electrotechnical Commission (IEC) define enclosure types based on the degree of protection an enclosure provides. Select a NEMA- or IEC-rated enclosure that suits your application and environment. The enclosure should be equipped with a disconnect device. To calculate the heat dissipation of your controller, refer to *Calculating Heat Dissipation* on page 9.

## Spacing Considerations

Follow the recommended minimum spacing shown below to allow for convection cooling within the enclosure. Cooling air in the enclosure must be kept within a range of 0°C to +60°C (+32°F to +140°F).

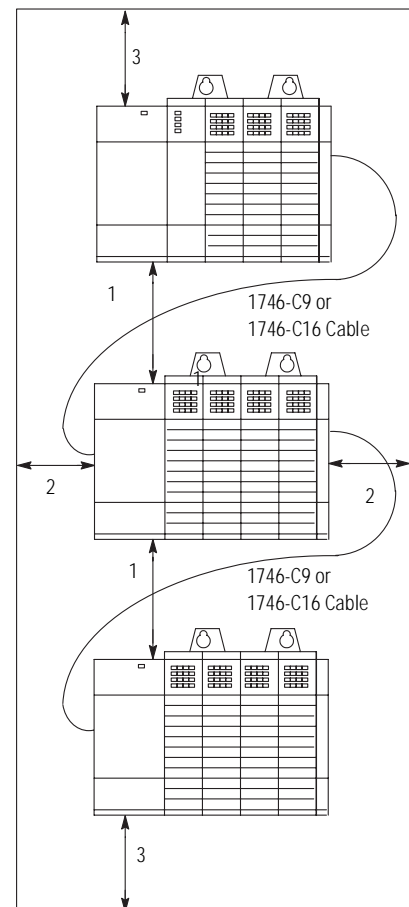
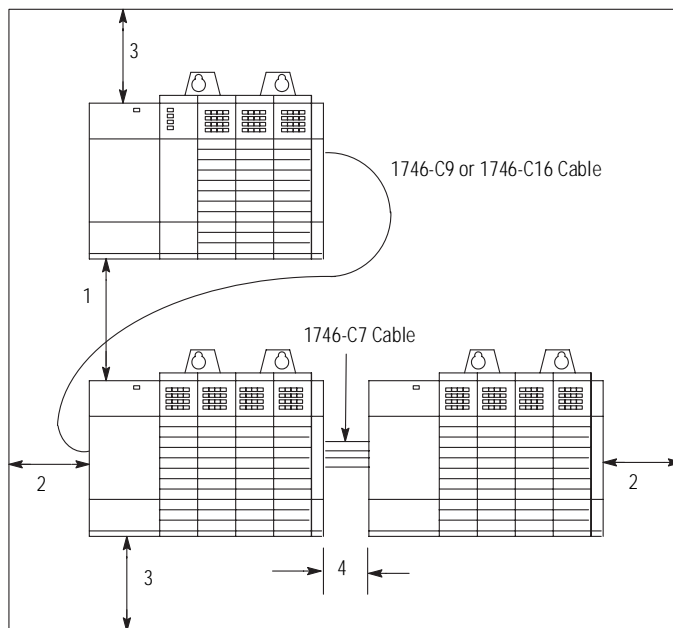

### Recommended Spacing

1. 15.3 to 20 cm (6 to 8 inches) when using the 1746-C9 cable
  - Note:** When making a vertical connection between two A13 chassis:
    - You must limit the space to 15.3 cm (6 inches) for the -C7 cable to reach from chassis to chassis.
    - You must limit the space to 92 cm (36 inches) for the -C9 cable to reach from chassis to chassis.
    - You must limit the space to 127 cm (50 inches) for the -C16 cable to reach from chassis to chassis.
2. Greater than 10.2 cm (4 inches)
3. Greater than 15.3 cm (6 inches)
4. 7.7 to 10.2 cm (3 to 4 inches) when using the 1746-C7 cable

## Grounding

In solid-state control systems, grounding helps limit the effects of noise due to electromagnetic interference (EMI). Ground connections should run from the chassis and power supply on each controller and expansion unit to the ground bus. Exact connections differ between applications. An authoritative source on grounding requirements for most installations is the National Electrical Code. Also, refer to *Allen-Bradley Industrial Automation Grounding and Wiring Guidelines*, Publication Number 1770-4.1.

The figure below shows you how to run ground connections from the chassis to the ground bus. Each chassis in the figure uses a different grounding method. Both methods are acceptable, but we recommend use of the ground bus because it reduces the electrical resistance at the connection.

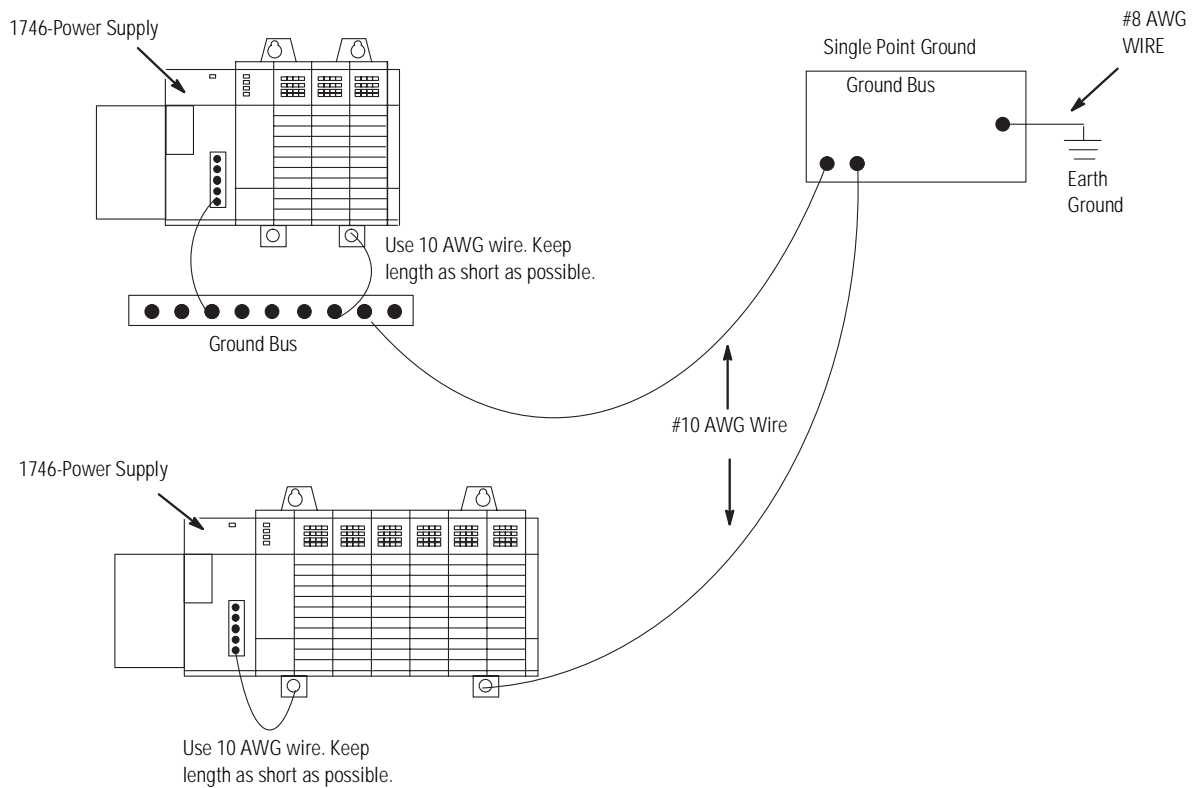

### ATTENTION



Your SLC 500 power supply can be damaged by voltage surges when switching inductive loads such as motors, motor starters, solenoids, and relays. To avoid damage to your SLC 500 power supply in these applications, it is strongly recommended that an isolation transformer be used to isolate the power supply from harmful voltage surges.

## Special Considerations in dc Applications

### ATTENTION



Any voltage applied to the 1746-P3 dc NEUT terminal will be present at the SLC logic ground and the processor DH-485 port. To prevent unwanted potentials across the logic ground of the controller and/or damage to the SLC chassis, the dc NEUTRAL of the external dc power source must be either isolated from the SLC chassis ground, or connected to earth ground. See the figure below.

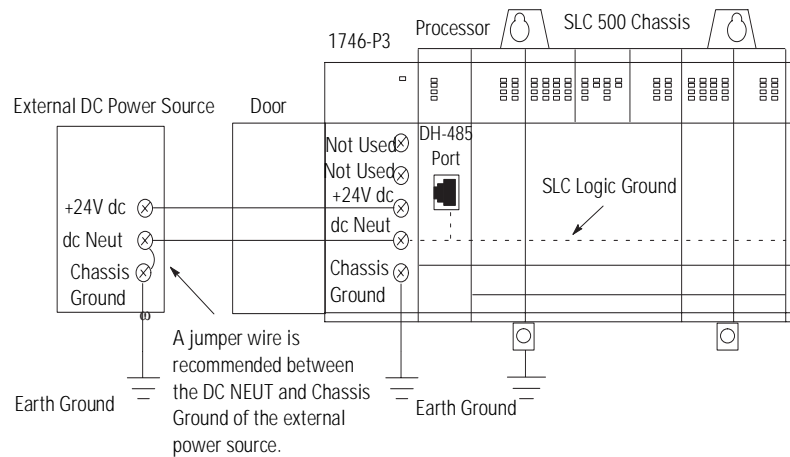

## Heat Dissipation

### Preventing Excessive Heat

For most applications, normal convection cooling keeps the controller components within the specified operating range (0-60°C). Proper spacing of components within the enclosure is usually sufficient for heat dissipation.

In some applications, a substantial amount of heat is produced by other equipment inside or outside the enclosure. In this case, place blower fans inside the enclosure to assist in air circulation and to reduce “hot spots” near the controller.

Additional cooling provisions might be necessary when high ambient temperatures are encountered.

### IMPORTANT

Do not bring unfiltered outside air into the enclosure. It may introduce harmful contaminants that could cause improper operation or damage to components. In extreme cases, you may need to use air conditioning to protect against heat build-up within the enclosure.

If you suspect heat build-up may be a problem, you can calculate the heat dissipation of your SLC control system. The following information can help you to make this calculation.



## Calculation Heat Dissipation

To calculate the heat dissipation of your SLC controller you must consider two things:

- the maximum heat dissipated (with field power applied) by the processor, all I/O and specialty modules, and any peripheral devices for each chassis.
- the heat dissipated by the power supply. This is determined by the maximum load on the power supply of the processor, each I/O and specialty module, peripheral device, and device drawing power directly off the power supply via the “POWER OUT” terminals.

You calculate maximum heat dissipation by using one of these methods:

- calculated watts method
- total watts method

Use calculated watts if you know exactly how many outputs and inputs on each card are active at any given time. This method will give you a lower, more accurate heat dissipation calculation than the total watts method. With this method, use the formula below for calculating the heat dissipation of each module. Then use these values in step 1 of the *Example Worksheet for Calculating Heat Dissipation* on page 11.

*(points energized x watts per point) + minimum watts = heat dissipation of module*

Use total watts if you are not sure how many points on a module are energized at any time. Total watts is the watts per point (with all points energized) plus the minimum watts. Total watts generated by each module are provided in the table on page 14.

Once you have determined which method you will use to calculate the heat dissipation of your modules, see the *Example Worksheet for Calculating Heat Dissipation* on page 11. This worksheet shows you how to calculate the heat dissipation for the example SLC control system on page 10.

## Example Heat Dissipation Calculation

If your controller consisted of the following hardware components, you would calculate heat dissipation as shown in the worksheet on page 11.

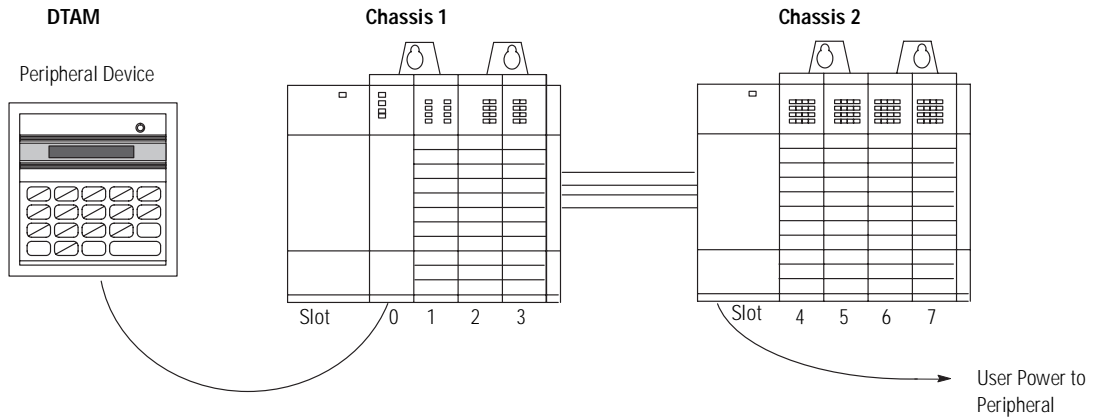

The following table details the total watts dissipated by the modules and peripheral devices in the above SLC 500 controller. The numbers were taken from the tables on page 14.

Chassis 1				Chassis 2			
Slot Number	Catalog Number	Min. Watts	Max. Watts	Slot Number	Catalog Number	Min. Watts	Max. Watts
0	1747-L511	1.75	1.75	4	1746-IA16	0.425	4.800
1	1746-BAS	3.750	3.80	5	1746-IA16	0.425	4.800
2	1746-IA8	0.250	2.40	6	1746-OW16	5.170	5.500 <sup>(2)</sup>
3	1746-OV8	0.675	6.90	7	1746-OW16	5.170	5.700
Peripheral Device	1747-DTAM	2.500	2.50	NA	NA	NA	NA
User Power to Peripheral	NA	NA	NA	NA	NA	2.400 <sup>(1)</sup>	NA

<sup>(1)</sup> The user power on the 1746-P1 power supply for Chassis 2 is being used to power a peripheral (100 mA at 24V dc).

<sup>(2)</sup> This output card uses 5.5 Watts because only 10 points are on at any one time. Using the calculated watts formula - (number of points energized x watts per point) + minimum watts = heat dissipation of module - the calculated watts for the 1746-OW16 module is 5.5W: (10 points x.33) + 5.17 = 5.5W.

## Example Worksheet for Calculating Heat Dissipation

**Procedure:**

1. Calculate the heat dissipation for each chassis without the power supply.
  - a. Write in the watts (calculated watts or total watts, see page 12) dissipated by the processor, I/O and specialty modules, and any peripheral devices attached to the processor. Then, for each chassis, add these values together.

Chassis 1		Chassis 2		Chassis 3		Chassis 1	Chassis 2	Chassis 3	Heat Dissipation
Cat No	Ht Dis	Cat No	Ht Dis	Cat No	Ht Dis				
<b>L511</b>	<b>1.75</b>	<b>IA16</b>	<b>4.8</b>						
<b>BAS</b>	<b>3.8</b>	<b>IA16</b>	<b>4.8</b>						
<b>IA8</b>	<b>2.4</b>	<b>OW16</b>	<b>5.5</b>						
<b>OV8</b>	<b>6.9</b>	<b>OW16</b>	<b>5.7</b>						
peripheral device:	<b>DTAM</b> 2.5								
peripheral device:									
<b>Total:</b>	<b>17.35</b>	<b>20.8</b>				17.35	20.8	—	

- b. Place the heat dissipation for each chassis into the appropriate columns.

2. Calculate the heat dissipation for each power supply.
  - a. Calculate the power supply loading for each chassis (write in the minimum watts) for each device (see page 14) add these values together.

**Important:** If you have a device connected to user power, multiply 24V by the current used. Include user power in the total power supply loading

Chassis 1		Chassis 2		Chassis 3		Chassis 1	Chassis 2	Chassis 3	Heat Dissipation
Cat No	Min Ht Dis	Cat No	Min Ht Dis	Cat No	Min Ht Dis				
<b>L511</b>	<b>1.75</b>	<b>IA16</b>	<b>0.425</b>						
<b>BAS</b>	<b>3.750</b>	<b>IA16</b>	<b>0.425</b>						
<b>IA8</b>	<b>0.250</b>	<b>OW16</b>	<b>5.17</b>						
<b>OV8</b>	<b>0.675</b>	<b>OW16</b>	<b>5.17</b>						
user power			<b>2.4</b>						
peripheral device:	<b>DTAM</b> 2.5								
peripheral device:									
<b>Total:</b>	<b>8.925</b>	<b>13.59</b>							

- b. Use the power supply loading for each chassis and the graphs on page 17 to determine the power supply dissipation. Place the power supply dissipations into the appropriate columns.

13.0	15.0	—
------	------	---

3. Add the chassis dissipation to the power supply dissipation.

## Dimension Drawings 4-Slot Modular Chassis

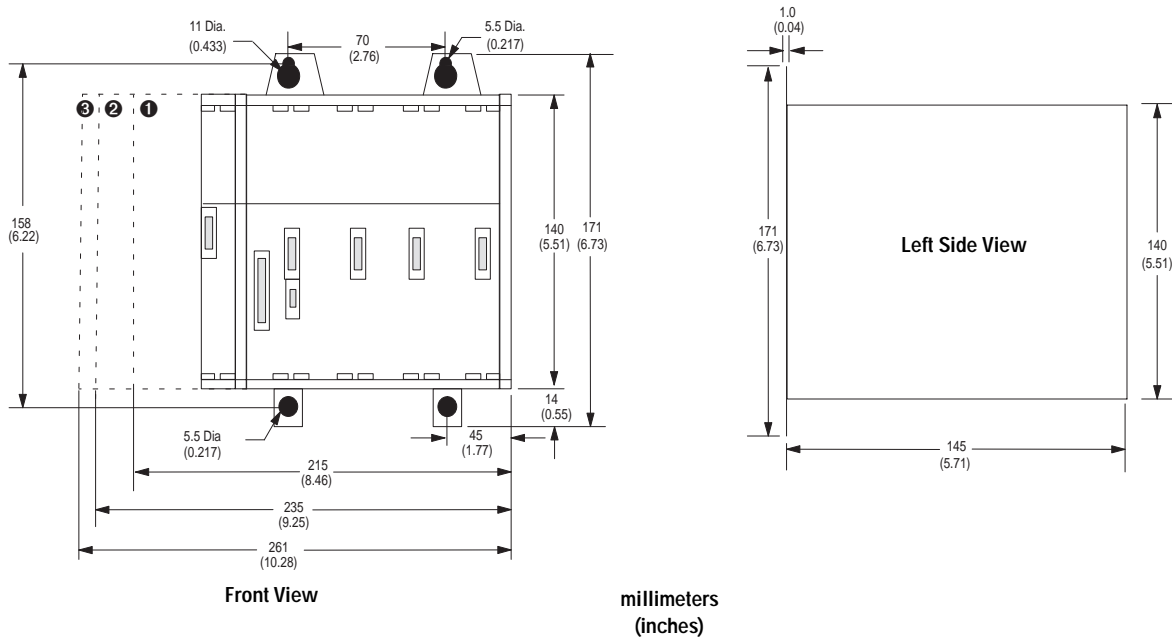

## 7-Slot Modular Chassis

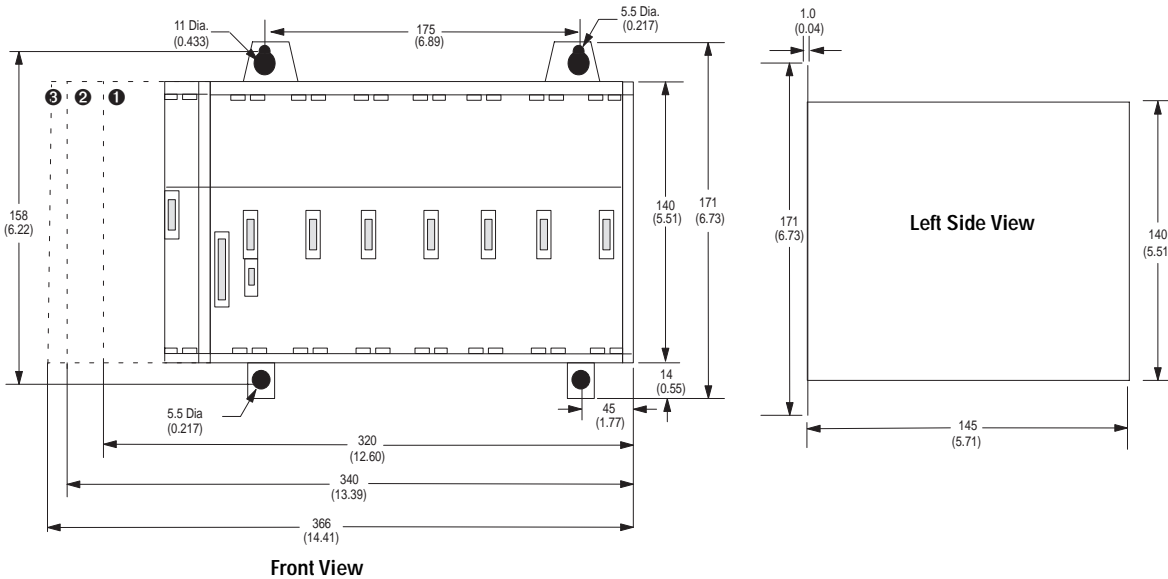

1. Dimensions for power supply catalog number 1746-P1
2. Dimensions for power supply catalog number 1746-P2, -P3, -P5 and -P6
3. Dimensions for power supply catalog number 1746-P4

### 10-Slot Modular Chassis

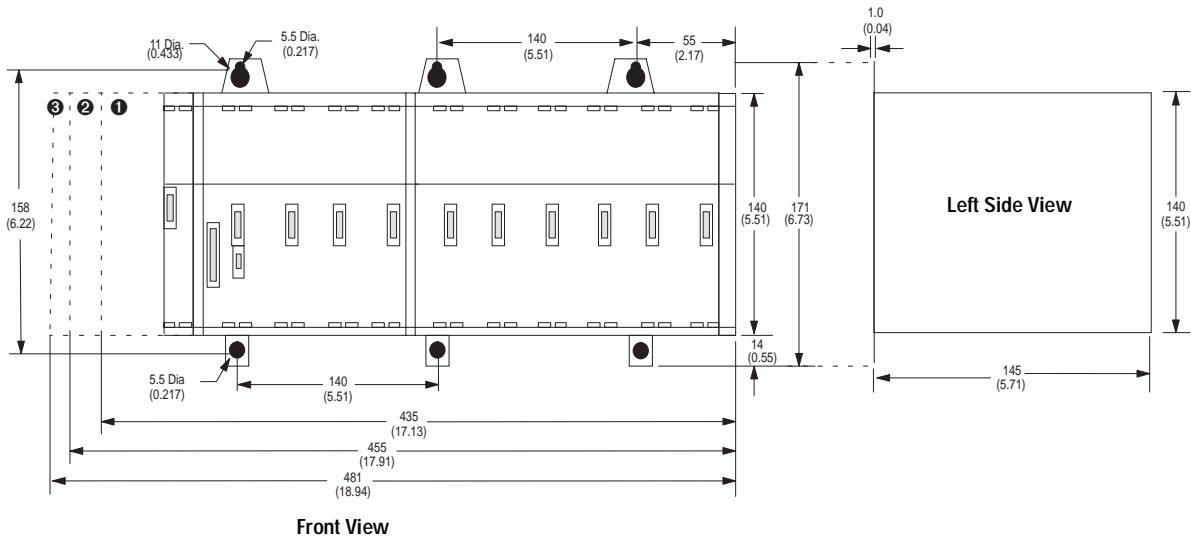

### 13-Slot Modular Chassis

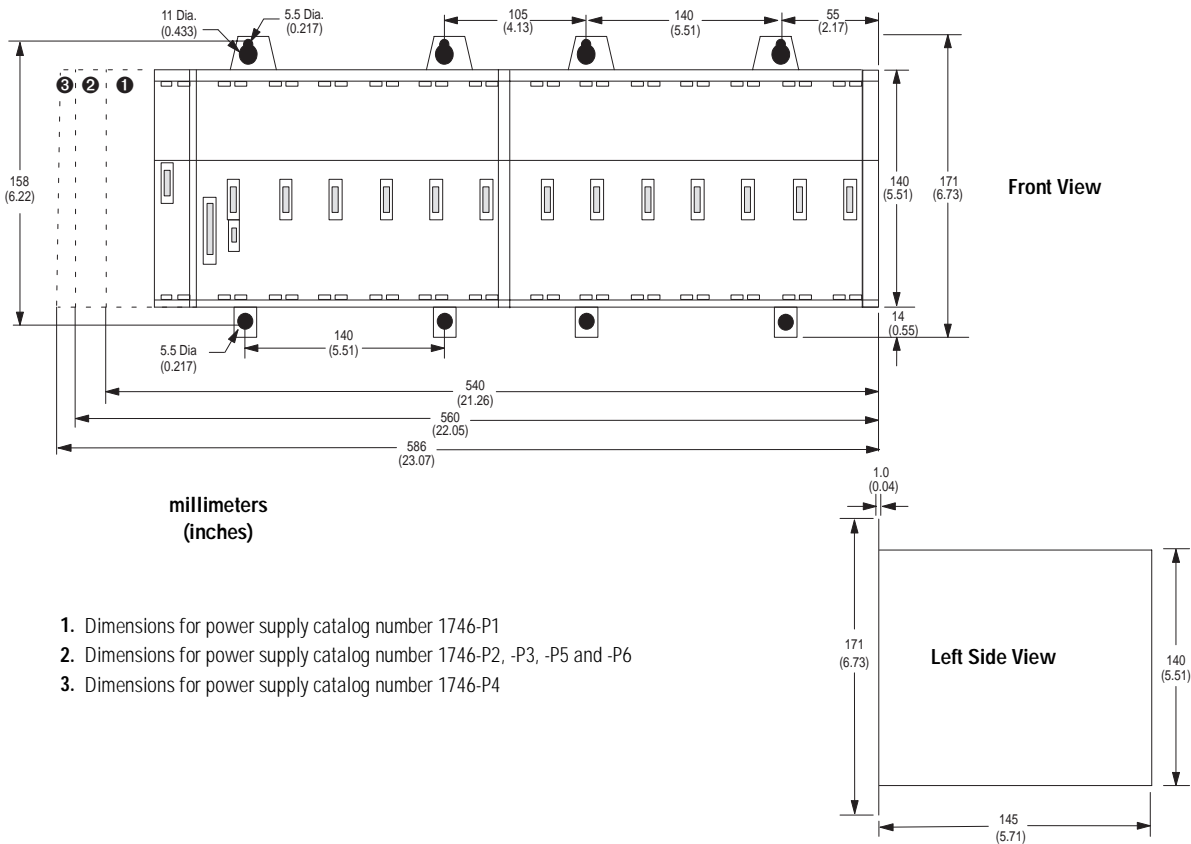

- millimeters (inches)
1. Dimensions for power supply catalog number 1746-P1
  2. Dimensions for power supply catalog number 1746-P2, -P3, -P5 and -P6
  3. Dimensions for power supply catalog number 1746-P4

## Reference Table and Graphs

## Power Supply Loading Reference Table

Use the table below to calculate the power supply loading and heat dissipation for each chassis in your SLC modular application. Definitions of some of the terms used in the table are provided on page 16.

Hardware Component	Catalog Numbers	Maximum Current (A)		Watts per Point	Minimum Watts	Total Watts
		at 5V dc	at 24V dc			
Processors	1747-L511	0.350	0.105	NA	1.75	1.75
	1747-L514	0.350	0.105	NA	1.75	1.75
	1747-L524	0.350	0.105	NA	1.75	1.75
	1747-L531	0.500	0.175	NA	1.75	1.75
	1747-L532	0.500	0.175	NA	2.90	2.90
	1747-L541	1.000	0.200	NA	4.00	4.00
	1747-L542	1.000	0.200	NA	4.00	4.00
	1747-L543	1.000	0.200	NA	4.00	4.00
	1747-L551	1.000	0.200	NA	4.00	4.00
	1747-L552	1.000	0.200	NA	4.00	4.00
	1747-L553	1.000	0.200	NA	4.00	4.00
Input Modules  (continued on Page 15)	1746-IA4	0.035	-	0.270	0.175	1.30
	1746-IA8	0.050	-	0.270	0.250	2.40
	1746-IA16	0.085	-	0.270	0.425	4.80
	1746-IB8	0.050	-	0.200	0.250	1.90
	1746-IB16	0.085	-	0.200	0.425	3.60
	1746-IB32 <sup>(1)</sup>	0.050	-	0.200	0.530	6.90
	1746-IC16	0.085	-	0.220	0.425	3.95
	1746-IG16	0.140	-	0.020	0.700	1.00
	1746-IH16	0.085	-	0.320	0.675	3.08
	1746-IM4	0.035	-	0.350	0.175	1.60
	1746-IM8	0.050	-	0.350	0.250	3.10
	1746-IM16	0.085	-	0.350	0.425	6.00
	1746-IN16	0.085	-	0.350	0.425	6.00
	1746-ITB16	0.085	-	0.200	0.425	3.625
	1746-ITV16	0.085	-	0.200	0.425	3.625
	1746-IV8	0.050	-	0.200	0.250	1.90
	1746-IV16	0.085	-	0.200	0.425	3.60
1746-IV32 <sup>(1)</sup>	0.050	-	0.200	0.530	6.90	

Hardware Component	Catalog Numbers	Maximum Current (A)		Watts per Point	Minimum Watts	Total Watts
		at 5V dc	at 24V dc			
Output Modules  (continued from Page 14)	<b>1746-OA8</b>	0.185	-	1.000	0.925	9.00
	<b>1746-OA16</b>	0.370	-	0.462	1.850	9.30
	<b>1746-OAP12</b>	0.370	-	1.000	1.850	10.85
	<b>1746-OB8</b>	0.135	-	0.775	0.675	6.90
	<b>1746-OB16</b>	0.280	-	0.338	1.400	7.60
	<b>1746-OB32<sup>(1)</sup></b>	0.190	-	0.078	2.260	4.80
	<b>1746-OBP8</b>	0.135	-	0.300	0.675	3.08
	<b>1746-OBP16</b>	0.250	-	0.310	1.250	6.21
	<b>1746-OB16E</b>	0.280	-	0.338	1.400	7.60
	<b>1746-OB32E</b>	0.452	-	0.078	2.260	4.80
Output Modules	<b>1746-OG16</b>	0.180	-	0.033	0.900	1.50
	<b>1746-OV8</b>	0.135	-	0.775	0.675	6.90
	<b>1746-OV16</b>	0.270	-	0.388	1.400	7.60
	<b>1746-OV32<sup>(1)</sup></b>	0.190	-	0.078	2.260	4.80
	<b>1746-OVP16</b>	0.250	-	0.310	1.250	6.21
	<b>1746-OW4</b>	0.045	0.045	0.133	1.310	1.90
	<b>1746-OW8</b>	0.085	0.090	0.138	2.590	3.70
	<b>1746-OW16</b>	0.170	0.180	0.033	5.170	5.70
	<b>1746-OX8</b>	0.085	0.090	0.825	2.590	8.60
Input and Output Modules	<b>1746-IO4</b>	0.030	0.025	0.270 per input pt. 0.133 per output pt.	0.750	1.60
	<b>1746-IO8</b>	0.060	0.045	0.270 per input pt. 0.133 per output pt.	1.380	3.00
	<b>1746-IO12</b>	0.090	0.070	0.270 per input pt. 0.133 per output pt.	2.130	4.60
	<b>1746-IO12DC</b>	0.080	0.060	0.200 per input pt. 0.133 per output pt.	1.840	3.90
Specialty Modules	<b>1746-BAS</b>	0.150	0.040 <sup>(2)</sup>	NA	3.750	3.800
	<b>1746-BLM</b>	0.110	0.085	NA		
	<b>1746-BTM</b>	0.110	0.085	NA		
	<b>1746-FIO4I</b>	0.055	0.150	NA	3.760	3.800
	<b>1746-FIO4V</b>	0.055	0.120	NA	3.040	3.100
	<b>1746-HSCE</b>	0.320	-	NA	1.600	1.600
	<b>1746-HSCE2</b>	0.250	-	NA		
	<b>1746-HSRV</b>	0.300	-	NA		
	<b>1746-HSTP1</b>	0.300	-	NA		
	<b>1746-INT4</b>	0.060	0.040	NA		
	<b>1746-MPM</b>	0.110	0.085	NA		
	<b>1746-NI4</b>	0.025	0.085	NA	2.170	2.20
	<b>1746-NI8</b>	0.200	0.100	NA		
	<b>1746-NI16</b>	0.200	0.100	NA		
	<b>1746-NIO4I</b>	0.055	0.145	NA	3.760	3.80

Hardware Component	Catalog Numbers	Maximum Current (A)		Watts per Point	Minimum Watts	Total Watts
		at 5V dc	at 24V dc			
	<b>1746-NIO4V</b>	0.055	0.115	NA	3.040	3.10
(continued from Page 15)	<b>1746-NO4I</b>	0.055	0.195	NA	4.960	5.00
	<b>1746-NO4V</b>	0.055	0.145	NA	3.780	3.80
	<b>1746-NR4</b>	0.050	0.050	NA	1.500	1.500
	<b>1746-NT4</b>	0.060	0.040	NA	0.800	0.800
	<b>1746-NT8</b>	0.120	0.070	NA		
	<b>1746-QS</b>	1.000	0.200	NA		
	<b>1746-QV</b>	0.215	-	NA		
Communication Modules	<b>1747-ACN15</b>	0.900	-	NA		
	<b>1747-ACNR15</b>	0.900	-	NA		
	<b>1747-ASB</b>	0.375	-	NA	1.875	1.875
	<b>1747-BSN</b>	0.800	0			
	<b>1747-DCM</b>	0.360	-	NA	1.800	1.800
	<b>1747-KE</b>	0.150	0.040 <sup>(2)</sup>	NA	3.750	3.800
	<b>1747-KFC15</b>	0.640	0	NA	3.200	3.200
	<b>1747-SCNR</b>	0.800	0.090	NA		
	<b>1747-SDN</b>	1.200	-	NA		
	<b>1747-SN</b>	0.900	-	NA	4.500	4.500
Peripheral Devices	<b>1747-AIC</b>	0	0.085	NA	2.000	2.000
	<b>1747-DTAM</b>	0	(3)	NA	2.500	2.500
	<b>1747-PIC</b>	0	(3)	NA	2.000	2.000
	<b>1747-PSD</b>	NA	NA	NA	NA	NA
	<b>1747-PT1 Series A and B</b>	0	(3)	NA	2.500	2.500
	<b>1761-NET-AIC<sup>(4)</sup></b>	0.350	0			

<sup>(1)</sup> Power supply loading for Series D and later modules.

<sup>(2)</sup> When using the BAS or KE modules to supply power to an AIC draws its power through the module. Add 0.085A (the current loading for the AIC) to the BAS or KE module's power supply loading value at 24V dc.

<sup>(3)</sup> The 24V dc loading values of the HHT, PIC, and DTAM are included in the 24V dc loading value of the processor.

<sup>(4)</sup> Current for the 1761-NET-AIC may be supplied from the controller communications port or from an external 24V dc source. No current is consumed from the controller when an external source is used.

**Watts per point** — the heat dissipation that can occur in each field wiring point when energized at nominal voltage.

**Minimum watts** — the amount of heat dissipation that can occur when there is no field power present.

**Total watts** — the watts per point plus the minimum watts (with all points energized)



## Power Supply Heat Dissipation Graphs

Use the graphs below for determining the power supply dissipation in step 2 of the *Example Worksheet for Calculating Heat Dissipation*.

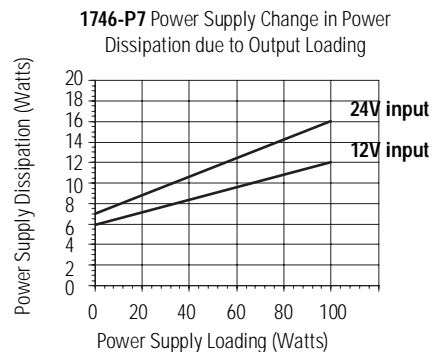
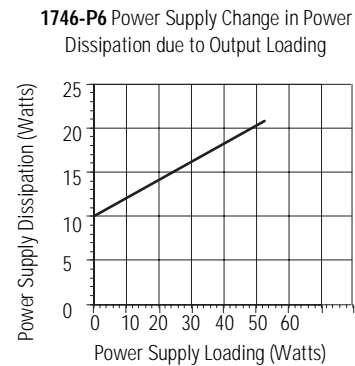
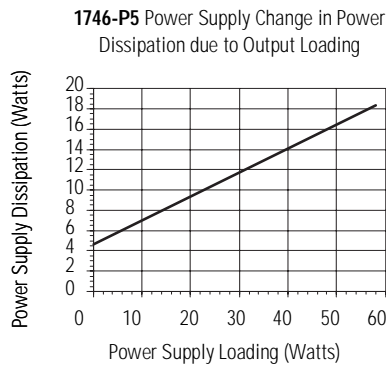
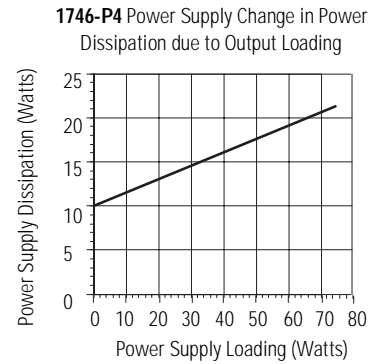
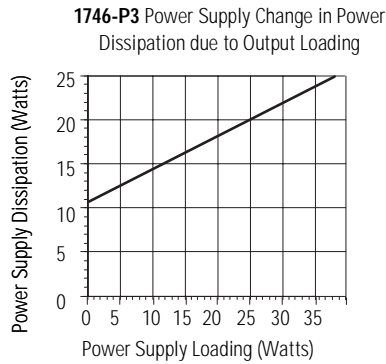
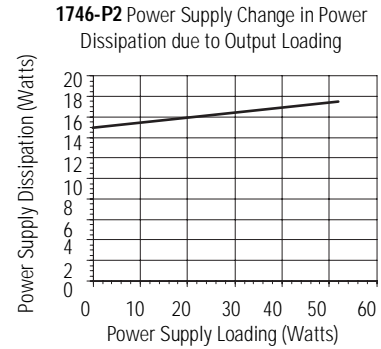
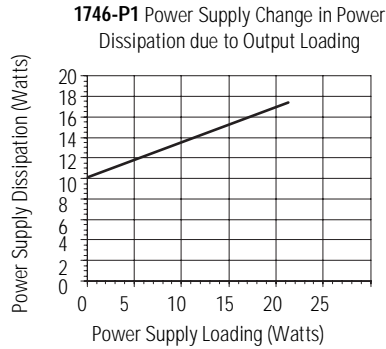

## Power Supply Specifications

Description:	Specification: 1746-							
	P1	P2	P3	P4	P5	P6	P7	
Line Voltage	85-132/170-265V ac 47-63 Hz		19.2-28.8V dc	85-132/ 170-265V ac 47-63 Hz	90-146V dc	30-60V dc	10-30V dc <sup>(1)</sup>	
Typical Line Power Reqmnt.	135 VA	180 VA	90 VA	240 VA	85VA	100VA	12V dc input: 50 VA	24V dc input: 75 VA
Maximum Inrush Current	20A			45A	20A		20A (required for turn-on)	
Internal Current Capacity	2A at 5V dc 0.46A at 24V dc	5A at 5V dc 0.96A at 24V dc	3.6A at 5V dc 0.87A at 24V dc	10.0A at 5V dc 2.88A at 24V dc <sup>(2)</sup>	5A at 5V dc 0.96A at 24V dc		12V dc input: 2.0A at 5V dc 0.46A at 24V dc	24V dc input: 3.6A at 5V dc 0.87A at 24V dc
Fuse Protection <sup>(3)</sup>	1746-F1 or equivalent <sup>(4)</sup>	1746-F2 or equivalent <sup>(5)</sup>	1746-F3 or equivalent <sup>(6)</sup>	Fuse is soldered in place.				
24V dc User Power Current Capacity	200 mA		Not Applicable	1A <sup>(2)</sup>	200 mA		Not Applicable	
24V dc User Power Volt. Range	18-30V dc			20.4-27.6V dc	18-30V dc			
Ambient Operating Temperature	0°C to +60°C (+32°F to +140°F) Current capacity is derated 5% above +55°C.			0°C to +60°C (+32°F to +140°F) no derating	0°C to +60°C (+32°F to +140°F) Current capacity is derated 5% above +55°C.			
Isolation <sup>(7)</sup>	1800V ac RMS for 1 s		None <sup>(8)</sup>	2600V dc for 1 s	1800V ac RMS for 1 s		600V ac RMS for 1 s	
CPU Hold-up Time <sup>(9)</sup>	20 ms (full load) 3000 ms (no load)		5 ms (full load) 1000 ms (no load)	20 ms (full load) 3000 ms (no load)	20 ms (full load) 3000 ms (no load)	5 ms (full load) 1500 ms (no load)	12V dc input: 1.37 ms at 0V dc (full load) 895 ms at 0V dc (no load) 10 ms at 9V dc (full load) continuous at 9V dc (no load)	24V dc input: 40 ms at 0V dc (full load) 1860 ms at 0V dc (no load) 790 ms at 11V dc (full load) continuous at 11V dc (no load)
Certification	UL listed C-UL or CSA certified (as indicated by product or packaging markings) CE compliant for all applicable directives							
Hazardous Environmt. Cert.	Class I Division 2							

- (1) See page 5 for information on power supply under voltage operation.
- (2) The combination of all output power (5 volt backplane, 24 volt backplane, and 24 volt user source) cannot exceed 70 watts.
- (3) Power supply fuse is intended to guard against fire hazard due to short-circuit conditions. This fuse may not protect the supply from miswiring or excessive transient in the power line.
- (5) Equivalent fuse: 250V-3A fuse, SANO SOC SD4, or BUSSMAN AGC 3
- (6) Equivalent fuse: 125V-3A fuse, Nagasawa ULCS-61ML-5, or BUSSMAN AGC 5
- (7) Isolation is between input terminals and backplane.
- (8) No isolation between input terminals and backplane. However, dielectric withstand between input terminals and chassis ground terminal is 600V ac RMS for 1 s.
- (9) CPU hold-up time is for 0V unless specified. Hold-up time is dependent on power supply loading.

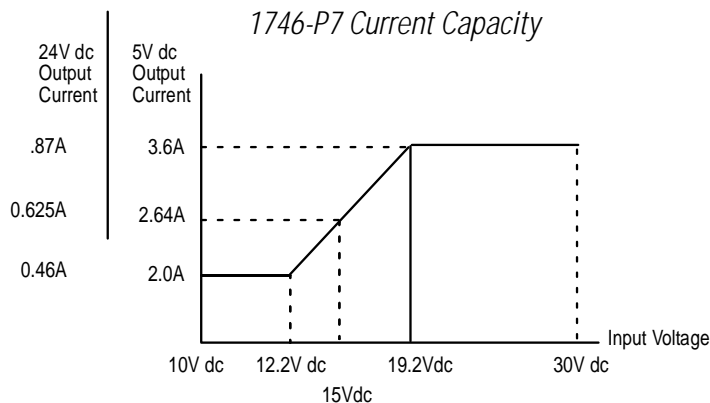

## Power Supply Selection Example

Select a power supply for chassis 1 and chassis 2 in the control system below. (The worksheet for this example is on page 20.)

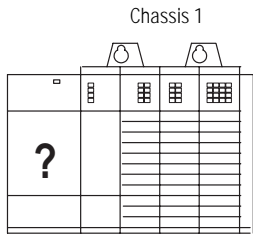
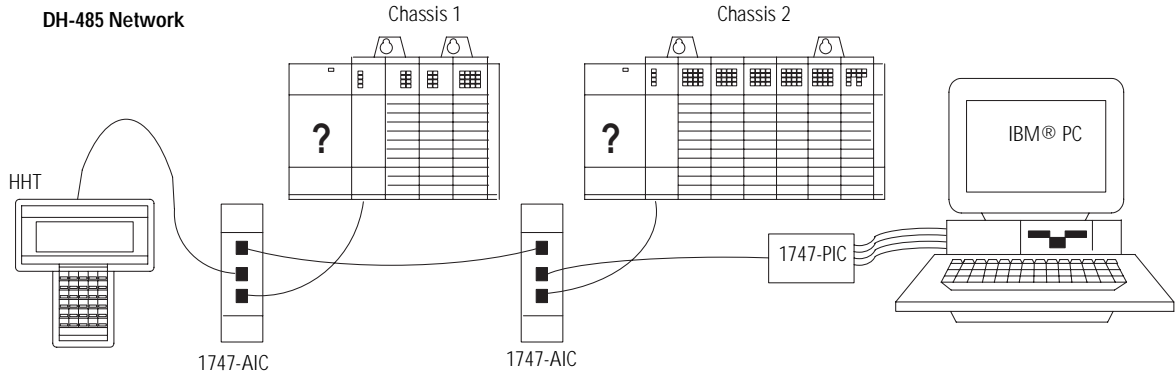

Slot Numbers	Description	Catalog Number	Power Supply at 5V dc (Amps)	Power Supply at 24V (Amps)
0	Processor Unit	1747-L511	0.35	0.105
1	Input Module	1747-IV8	0.05	NA
2	Transistor Output Module	1746-OB8	0.135	NA
3	Triac Output Module	1746-OA16	0.37	NA
Peripheral Device	Hand-Held Terminal	1747-PT1	NA	NA
Peripheral Device	Isolated Link Coupler	1747-AIC	NA	NA
<b>Total Current:</b>			0.905	0.190 <sup>(1)</sup>

<sup>(1)</sup> Power Supply 1746-P1 is sufficient for Chassis #1. The "Internal Current Capacity" for this power supply is 2 Amps at 5V dc; 0.46 Amps at 24V dc.

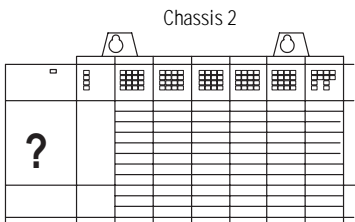

Slot Numbers	Description	Catalog Number	Power Supply at 5V dc (Amps)	Power Supply at 24V (Amps)
0	Processor Unit	1747-L514	0.35	0.105
1	Output Module	1746-OW16	0.17	0.180
2	Combination Module	1746-IO12	0.09	.07
3,4,5,6	Analog Output Modules	1746-NO4I	0.22 (4 x 0.055)	0.780 (4 x 0.195)
Peripheral Device	Isolated Link Coupler	1747-AIC	NA	0.085
Peripheral Device	Interface Converter	1746-PIC	NA	NA
<b>Total Current:</b>			0.83	1.22 <sup>(1)</sup>

<sup>(1)</sup> Power Supply 1746-P4 is sufficient for Chassis #2. The "Internal Current Capacity" for this power supply is 10 Amps at 5V dc; not to exceed 70 Watts. (This configuration = 33.43 Watts, i.e., [5V x 0.083] + [24V x 1.22A] = 33.43W)

## Example Worksheet for Selecting 1746 Power Supplies for the Example System

If you have a multiple chassis system, make copies of the Worksheet for Selecting a Power Supply found on page 22. For a detailed list of device load currents, see page 14. Remember to consider future system expansion when selecting a power supply.

Procedure																					
1. For each slot of the chassis that contains a module, list the slot number, the catalog number of the module, and its 5V and 24V maximum currents. Also include the power consumption of any peripheral devices that may be connected to the processor other than a DTAM, HHT, or PIC—the power consumption of these devices is accounted for in the power consumption of the processor.																					
Chassis Number		1			Maximum Currents			Chassis Number		2			Maximum Currents								
Slot Number		Catalog Number			at 5V dc			at 24V dc			Slot Number		Catalog Number			at 5V dc			at 24V dc		
Slot	0	1747-L511			0.350A			0.105A			Slot	0	1747-L514			0.350A			0.105A		
Slot	1	1746-IV8			0.050A			-			Slot	1	1746-OW16			0.170A			0.180A		
Slot	2	1746-OB8			0.135A			-			Slot	2	1746-NO4I			0.055A			0.195A		
Slot	3	1746-OA16			0.370A			-			Slot	3	1746-NO4I			0.055A			0.195A		
Slot											Slot	4	1746-NO4I			0.055A			0.195A		
Slot											Slot	5	1746-NO4I			0.055A			0.195A		
Slot											Slot	6	1746-IO12			0.090A			0.070A		
Slot											Slot										
Peripheral Device		A/C			-			0.085A			Peripheral Device		A/C			-			0.085A		
Peripheral Device											Peripheral Device										
2. Add the loading currents of all the system devices at 5 and 24V dc to determine the Total Current.				<b>0.905A</b>			<b>0.190A</b>			2. Add the loading currents of all the system devices at 5 and 24V dc to determine the Total Current.				<b>0.830A</b>			<b>1.220A</b>				
3. For 1746-P4 power supplies, calculate the total power consumption of all system devices. If you are not using a 1746-P4, go to step 4.																					
Current				Multiply by = Watts				Current				Multiply by = Watts									
Total Current at 5V dc		0.905A		5V		4.525W		Total Current at 5V dc		0.830A		5V		4.15W							
Total Current at 24V dc		0.190A		24V		4.56W		Total Current at 24V dc		1.220A		24V		29.28W							
User Current at 24V dc		0.500A		24V		12.00W		User Current at 24V dc		0.500A		24V		12.00W							
<b>Add the Watts values to determine Total Power (cannot exceed 70 Watts)</b>				<b>21.085W</b>				<b>Add the Watts values to determine Total Power (cannot exceed 70 Watts)</b>				<b>45.43W</b>									
4. Choose the power supply from the list of catalog numbers shown below. Compare the Total Current required for the chassis with the Internal Current capacity of the power supplies. Be sure that the Total Current consumption for the chassis is less than the Internal Current Capacity for the power supply, for both 5V and 24V loads.																					
Catalog Number			Internal Current Capacity			Catalog Number			Internal Current Capacity												
			at 5V dc		at 24V dc				at 5V dc		at 24V dc										
1746-P1			2.0A		0.46A	1746-P1			2.0A		0.46A										
1746-P2			5.0A		0.96A	1746-P2			5.0A		0.96A										
1746-P3			3.6A		0.87A	1746-P3			3.6A		0.87A										
1746-P4 (see step 3)			10.0A		2.88A	1746-P4 (see step 3)			10.0A		2.88A										
1746-P5			5.0A		0.96A	1746-P5			5.0A		0.96A										
1746-P6						1746-P6															
1746-P7						1746-P7															
<b>Required Power Supply</b>			<b>1746-P1</b>			<b>Required Power Supply</b>			<b>1746-P4</b>												

## Allen-Bradley Support

In today's competitive environment, when you buy any product, you expect that product to meet your needs. You also expect the manufacturer of that product to back it up with the kind of customer service and product support that will prove you made a wise purchase.

As the people who design, engineer, and manufacture your Industrial Automation Control equipment, Allen-Bradley has a vested interest in your complete satisfaction with our products and services.

Allen-Bradley offers support services worldwide, with over 75 Sales/Support Offices, 512 authorized Distributors and 260 authorized Systems Integrators located throughout the United States alone, plus Allen-Bradley representatives in every major country in the world.

Contact your local Allen-Bradley representative for:

- sales and order support
- product technical training
- warranty support
- support service agreements

# Worksheets

## Blank Worksheets for Selecting a 1746 Power Supply

(For a detailed list of device load currents, see page 14.) Remember to consider future system expansion when selecting a power supply.

Procedure							
1. For each slot of the chassis that contains a module, list the slot number, the catalog number of the module, and its 5V and 24V maximum currents. Also include the power consumption of any peripheral devices that may be connected to the processor other than a DTAM, HHT, or PIC—the power consumption of these devices is accounted for in the power consumption of the processor.							
Chassis Number		Maximum Currents		Chassis Number		Maximum Currents	
Slot Number	Catalog Number	at 5V dc	at 24V dc	Slot Number	Catalog Number	at 5V dc	at 24V dc
Slot				Slot			
Slot				Slot			
Slot				Slot			
Slot				Slot			
Slot				Slot			
Slot				Slot			
Slot				Slot			
Slot				Slot			
Peripheral Device				Peripheral Device			
Peripheral Device				Peripheral Device			
2. Add the loading currents of all the system devices at 5 and 24V dc to determine the <b>Total Current</b> .				2. Add the loading currents of all the system devices at 5 and 24V dc to determine the <b>Total Current</b> .			
3. For 1746-P4 power supplies, calculate the total power consumption of all system devices. If you are not using a 1746-P4, go to step 4.							
Current		Multiply by = Watts		Current		Multiply by = Watts	
Total Current at 5V dc		5V		Total Current at 5V dc		5V	
Total Current at 24V dc		24V		Total Current at 24V dc		24V	
User Current at 24V dc		24V		User Current at 24V dc		24V	
<b>Add the Watts values to determine Total Power (cannot exceed 70 Watts)</b>				<b>Add the Watts values to determine Total Power (cannot exceed 70 Watts)</b>			
4. Choose the power supply from the list of catalog numbers shown below. Compare the Total Current required for the chassis with the Internal Current capacity of the power supplies. Be sure that the Total Current consumption for the chassis is less than the Internal Current Capacity for the power supply, for both 5V and 24V loads.							
Catalog Number		Internal Current Capacity		Catalog Number		Internal Current Capacity	
		at 5V dc	at 24V dc			at 5V dc	at 24V dc
1746-P1		2.0A	0.46A	1746-P1		2.0A	0.46A
1746-P2		5.0A	0.96A	1746-P2		5.0A	0.96A
1746-P3		3.6A	0.87A	1746-P3		3.6A	0.87A
1746-P4 (see step 3)		10.0A	2.88A	1746-P4 (see step 3)		10.0A	2.88A
1746-P5		5.0A	0.96A	1746-P5		5.0A	0.96A
1746-P6				1746-P6			
1746-P7				1746-P7			
<b>Required Power Supply</b>				<b>Required Power Supply</b>			



SLC 500 and DTAM are trademarks of Rockwell Automation.  
IBM is a registered trademark of International Business Machines Corporation.

---

**Reach us now at [www.rockwellautomation.com](http://www.rockwellautomation.com)**

Wherever you need us, Rockwell Automation brings together leading brands in industrial automation including Allen-Bradley controls, Reliance Electric power transmission products, Dodge mechanical power transmission components, and Rockwell Software. Rockwell Automation's unique, flexible approach to helping customers achieve a competitive advantage is supported by thousands of authorized partners, distributors and system integrators around the world.

**Americas Headquarters**, 1201 South Second Street, Milwaukee, WI 53204, USA, Tel: (1) 414 382-2000, Fax: (1) 414 382-4444  
**European Headquarters SA/NV**, avenue Herrmann Debroux, 46, 1160 Brussels, Belgium, Tel: (32) 2 663 06 00, Fax: (32) 2 663 06 40  
**Asia Pacific Headquarters**, 27/F Citicorp Centre, 18 Whitfield Road, Causeway Bay, Hong Kong, Tel: (852) 2887 4788, Fax: (852) 2508 1846

Publication 1746-TD003A-EN-P - April 2000

Supersedes Publication 1746-2.38 - December 1996



© 2000 Rockwell International Corporation. All Rights Reserved. Printed in USA.