



SLC 500™ Family of Small Programmable Controllers

System Overview

Table of Contents

| | |
|---|--------------------|
| Overview | 1 |
| SLC 500 Family | 1 |
| MicroLogix 1000 Family | 2 |
| New Product Summary | 2 |
| SLC 500 System Configuration | 3 |
| MicroLogix 1000 | 4 |
| Types | 5 |
| General Specifications | 5 |
| Input Specifications | 6 |
| DC Input Filter Settings | 6 |
| AC Input Filter Settings | 6 |
| Output Specifications | 7 |
| Relay Contact Rating Table | 7 |
| Hand-Held Programmer Specifications | 7 |
| SLC 500 Fixed Controller | 8 |
| Specifications | 9 |
| SLC 500 Modular Controller | 11 |
| Communication Options | 13 |
| System Protection Options | 14 |
| Memory Modules | 14 |
| SLC 500 Family Specifications | 15 |
| Power Supply Options | 16 |
| Chassis Options | 17 |
| 1746 Discrete I/O Modules | 17 |
| 1746 Discrete Input Modules | 18 |
| 1746 Discrete Output Modules | 19 |
| Relay Contact Rating Chart | 20 |
| 1746 Discrete Combination Modules | 20 |
| Bulletin 1492 Interface Modules and Cables | 21 |
| Speciality I/O Modules | 22 |
| 1746 I/O Analog Modules | 22 |
| Specifications | 24 |
| 1746-NT4 Thermocouple/mV Module | 24 |
| Thermocouple Temperature Ranges | 25 |
| DC Millivolt Input Ranges | 25 |
| Specifications | 26 |
| 1746-NR4 RTD/resistance Input Module | 27 |
| RTD Temperature Ranges, Resolution, and Repeatability | 28 |
| RTD Accuracy and Temperature Drift Specifications | 29 |
| Resistance Input Specifications | 30 |
| Specifications | 30 |
| 1746-HSCE High-Speed Counter Module | 31 |
| Specifications | 31 |
| 1746-HSTP1 Stepper Controller Module | 32 |
| 1746-HS IMCE 110 Servo Positioning Module | 33 |

| | |
|--|--------------------|
| Remote I/O Modules | 34 |
| 1747-SN Remote I/O Scanner | 34 |
| 1747-ASB Remote I/O Adapter Module | 35 |
| Specifications for 1747-SN and 1747-ASB | 35 |
| Remote I/O Specifications | 35 |
| 1747-DCM Direct Communication Module | 36 |
| Specifications | 36 |
| Remote I/O Devices | 37 |
| 1791 Block I/O | 37 |
| 1794 Flex I/O | 37 |
| 2705 RediPANEL Operator Modules | 37 |
| 2706 Dataliner Message Displays | 37 |
| Drives | 37 |
| Pyramid Solutions Program (PSP) | 38 |
| DeviceNet Network | 39 |
| DeviceNet Network Length | 39 |
| Remote Communication | 40 |
| 1747-KE DH-485/RS-232C Interface Module | 40 |
| 1746-BAS BASIC Module and BASIC Development Software | 40 |
| 1770-KF3 DH-485 Communication Interface Module | 41 |
| Remote Communication Functions | 41 |
| Networking Options | 42 |
| 1784-KR Personal Computer Interface Card | 42 |
| Specifications | 42 |
| 6001-F2E Standard Driver | 43 |
| 1747-AIC Isolated Link Coupler for DH-485 Connection | 43 |
| Programming Options | 44 |
| 1747-PA2E Advanced Programming Software | 44 |
| System Specifications | 45 |
| 1747-PIC Interface Converter Programming Options | 45 |
| Specifications | 46 |
| Operator Interface | 48 |
| 1747-DTAM-E Data Table Access Module | 48 |
| Specifications | 49 |
| Bulletin 2707 DTAM Plus Operator Interface | 49 |
| Bulletin 2707 DTAM Micro | 49 |
| 1784-TM6 I/O Monitor | 50 |
| 2711 PanelView Operator Terminals | 50 |
| Allen-Bradley Support | 51 |
| User Documentation on CD-ROM | 51 |
| Configuring an SLC 500 System | 51 |
| SLC 500 Chassis Configuration Instructions | 52 |
| Fixed I/O Chassis Module Compatibility | 54 |
| Tabular Method | 54 |
| Fixed I/O Chassis – Module Compatibility Table | 55 |
| Charting Method | 56 |

| | |
|--|--------------------|
| Instruction Set | 57 |
| Fixed Wiring Diagrams | 58 |
| Approximate Chassis Dimensions millimeters (inches) | 60 |
| Available Cables | 63 |
| Programming Options | 44 |
| Programming Options | 45 |
| 1747-PT1 Hand-Held Terminal and 1747-PTA1E Programming Memory Pak Programming Options | 46 |
| Programming Options | 46 |
| SLC 500 A.I. Series Programming Software Programming Options | 47 |
| Programming Options | 47 |
| Configuring an SLC 500 System | 61 |

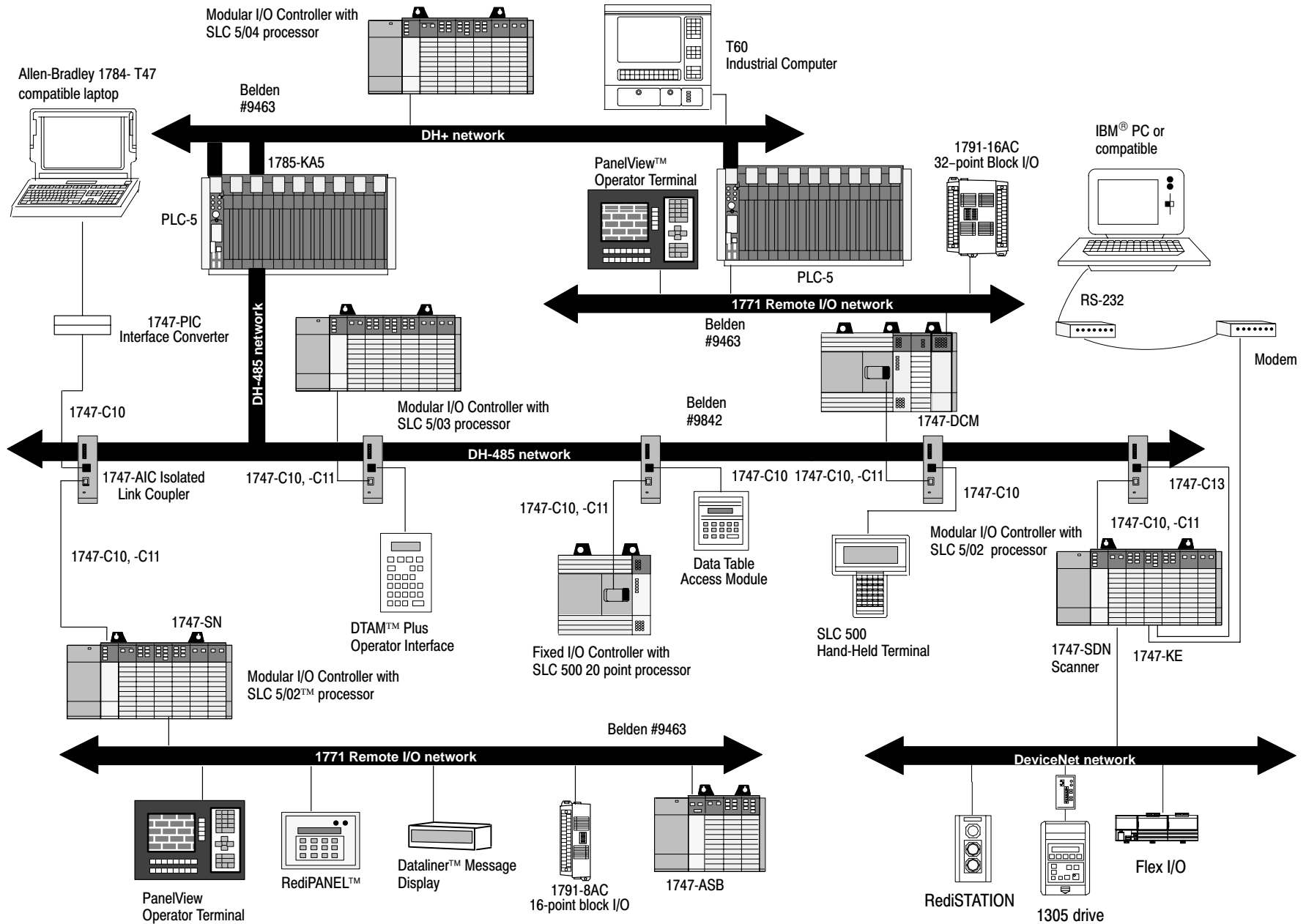

Overview

Both the SLC 500™ family and the MicroLogix™ family give you power and flexibility for a complete control solution. The powerful processor instruction sets, advanced programming tools, and expanded product capabilities give you all of the right reasons to choose these products for your next control application.

SLC 500 Family

The SLC 500 family is a growing family of small programmable controllers built around two hardware options: a fixed controller or a modular controller. The fixed controller provides the power supply, inputs and outputs, and processor all in one unit. The fixed controller also offers a 2-slot expansion chassis for increased flexibility.

The modular controller offers you additional flexibility in system configuration, more processing power, and I/O capacity. This allows you to create a controller system specifically designed for your application. The programming tools and most I/O modules are compatible between the two hardware options, so you can cost effectively solve a broad range of applications.

In addition to configuration flexibility, SLC 500 programmable controllers communicate across an embedded DH-485 network allowing program support and monitoring. The SLC 5/03™ processor, Catalog Number 1747-L532 provides up to 960 I/O points, online programming, and a keyswitch for selecting 1 of 3 modes of operation (Run, Program and Remote). Also included in the SLC 5/03 processor is an RS-232 channel that supports asynchronous serial data communication between terminal devices. The SLC 5/04™ processors, Catalog Numbers 1747-L541, 1747-L542, and 1747-L543, provide the same features as the SLC 5/03 with additional functions. For example, the SLC 5/04 processor provides an on-board math co-processor for faster execution times of math instructions. It also has a built-in Data Highway Plus™ (DH+™) port for direct connection to the DH+ network. Direct DH+ connection allows the SLC 5/04 to communicate with PLC-5® processors on the DH+ network without the need for additional network interface hardware. For implementation of a distributed I/O system, any SLC 500 programmable controller used with the Direct Communication Module (DCM), the Scanner Module (SN), or the DeviceNet™ Scanner Module (SDN) integrates into the Allen-Bradley 1771 Remote I/O network and DeviceNet network respectively.

The SLC 500 family offers a variety of discrete I/O modules that enable you to cost-effectively configure your control system. The addition of 32 point I/O modules reduces panel space requirements. All of the discrete and specialty I/O modules are UL and CSA certified for industrial applications. The majority are approved for Class I, Division 2 hazardous environments. Most of the SLC 500 modular components are CE compliant. Refer to the product specifications for specific agency certifications.

MicroLogix 1000 Family

The MicroLogix 1000 family of programmable controllers is designed to meet your control needs in a variety of applications requiring under 32 I/O. Positioned as part of the SLC 500 family, the MicroLogix 1000 family offers you a small, low-cost programmable controller with a powerful instruction set and fast execution speed for high throughput. Like the SLC 500 family, the MicroLogix controllers are programmed using familiar ladder logic.

The MicroLogix 1000 controllers can be programmed using MicroLogix 1000 Programming Software (MPS) A.I. Series™, SLC 500 A.I. Series programming software, or the MicroLogix 1000 Hand-Held Programmer (HHP).

New Product Summary

The following table shows the page references for the new SLC 500 MicroLogix 1000 products and other related product lines:

| Catalog Number | Description | Page Number |
|-----------------------------|--|-------------|
| 9323-MX300EN | MicroLogix 1000 Programming Software (MPS) A.I. Series | 4 |
| 9323-S5300D | SLC 500 A.I. Series programming software | 4 |
| 1761-L32AAA | MicroLogix 1000 Programmable Controller | 5 |
| 1747-L542, -L543 | SLC 5/04 Processors | 11 |
| 1746-FIO4I, -FIO4V | Analog I/O Modules | 22 |
| Not Applicable ^① | DeviceNet | 39 |

^① DeviceNet is made up of various devices that have their own catalog numbers.

SLC 500 System Configuration

MicroLogix 1000

The MicroLogix 1000 Programmable Controller supplements the SLC 500 controller family by providing a small, low cost version that offers outstanding performance, superior reliability, and high quality. This product family offers you several types of controllers, development tools, and operator interfaces to meet your control needs for a variety of applications.

The MicroLogix 1000 controllers can be programmed using MicroLogix 1000 Programming Software (MPS) A.I. Series, SLC 500 A.I. Series programming software, or the MicroLogix 1000 Hand-Held Programmer (HHP).

For dimensions of the MicroLogix 1000 units, refer to page [60](#).

Features

16 or 32 I/O versions with 4 different electrical configurations

1K user memory capacity

Over 65 programming instructions

Built-in EEPROM memory

RS-232 communication channel

Compact size

Benefits

Provides flexibility to meet the needs of almost any application.

Provides enough memory capability to meet most application needs.

Provides powerful instruction set to develop the right program for the application.

Retains program and data after a power failure. No need for battery backup or additional memory module.

Provides connection to a personal computer, operator interface, and modem.

Enables the unit to fit in tight spaces.

Types

| Catalog Number | Description |
|----------------|---|
| 1761-L16AWA | 10 pt. AC input, 6 pt. relay output, AC power supply controller |
| 1761-L32AWA | 20 pt. AC input, 12 pt. relay output, AC power supply controller |
| 1761-L16BWA | 10 pt. DC input, 6 pt. relay output, AC power supply controller |
| 1761-L32BWA | 20 pt. DC input, 12 pt. relay output, AC power supply controller |
| 1761-L16BWB | 10 pt. DC input, 6 pt. relay output, DC power supply controller |
| 1761-L32BWB | 20 pt. DC input, 12 pt. relay output, DC power supply controller |
| 1761-L16BBB | 10 pt. DC input, 4 pt. FET and 2 pt. relay outputs, DC power supply controller |
| 1761-L32BBB | 20 pt. DC input, 10 pt. FET and 2 pt. relay outputs, DC power supply controller |
| 1761-L32AAA | 20 pt. AC input, 10 pt. triac and 2 pt. relay outputs, AC power supply controller |

General Specifications

| Description | Specification: 1761-L | | | | | | | | | |
|---|---|----------------|----------------|-------------|----------------|---------------|----------------|-------|-------|------|
| | 16AWA | 16BWA | 32AWA | 32BWA | 32AAA | 16BBB | 16BWB | 32BBB | 32BWB | |
| Memory Size and Type | 1K EEPROM (approximately 737 instruction words: 437 data words) | | | | | | | | | |
| Power Supply Voltage | 85–264V ac | | | | | 20.4–26.4V dc | | | | |
| Power Supply Usage | 120V ac | 12 VA | 19 VA | 16 VA | 24 VA | 16 VA | Not Applicable | | | |
| | 240V ac | 18 VA | 26 VA | 22 VA | 30 VA | 22 VA | | | | |
| | 24V dc | Not Applicable | | | | | 5 VA | 5 VA | 7 VA | 7 VA |
| Power Supply Maximum Inrush Current | 20A | | | | | 50A | | | | |
| 24V dc Sensor Power (V dc at mA) | Not Applicable | 200 mA | Not Applicable | 200 mA | Not Applicable | | | | | |
| Max Capacitive Load (User 24 V dc) | Not Applicable | 200 μ F | Not Applicable | 200 μ F | | | | | | |
| Power Cycles | 50,000 minimum | | | | | | | | | |
| Operating Temperature | 0° C to 55° C (32° F to 131° F) | | | | | | | | | |
| Storage Temperature | –40° C to 85° C (–40° F to 185° F) | | | | | | | | | |
| Operating Humidity | 5 to 95% noncondensing | | | | | | | | | |
| Vibration | Operating: 5 Hz to 2k Hz, 0.381 mm (0.015 in.) peak to peak/2.5G panel mounted, ^① 1hr per axis | | | | | | | | | |
| | Non-operating: 5 Hz to 2k Hz, 0.762 mm (0.030 in.) peak to peak/5G, 1hr per axis | | | | | | | | | |
| Shock | Operating: 10G peak acceleration (7.5g DIN rail mounted) ^② (11 \pm 1 ms duration) 3 times each direction, each axis | | | | | | | | | |
| | Non-operating: 20G peak acceleration (11 \pm 1 ms duration), 3 times each direction, each axis | | | | | | | | | |
| Certification (when product or packaging is marked) | <ul style="list-style-type: none"> • CSA certified • UL listed • CE marked for all applicable directives | | | | | | | | | |
| Terminal Screw Torque | 0.9 N-m maximum.C (8.0 in.-lbs) | | | | | | | | | |
| Electrostatic Discharge | IEC801-2 @ 8K V | | | | | | | | | |
| Radiated Susceptibility | IEC801-3 @ 10 V/m, 27 MHz - 1000 MHz | | | | | | | | | |
| Fast Transient | IEC801-4 @ 2K V Power Supply, 1K V I/O | | | | | | | | | |
| Isolation | 1500V ac | | | | | | | | | |

^① DIN rail mounted controller is 1G.

^② Relays are derated an additional 2.5G on 32 pt. controllers.

Input Specifications

| Description | Specification | |
|-------------------|---|--|
| Type | 100-120V ac | 24V dc |
| Voltage Range | 79 to 132V ac 47 to 63 Hz | 15 to 30V dc |
| On Voltage | 79V ac min. 132V ac max. | 15V dc min. 24V dc nominal 26.4V dc max. @ 55° C (131° F) 30.0V dc max. @ 30° C (86° F) |
| Off Voltage | 20V ac | 5V dc |
| On Current | 5.0 mA min. @ 79V ac 47 Hz 12.0 mA nominal @ 120V ac 60 Hz 16.0 mA max. @ 132V ac 63 Hz | 2.5 mA min. @ 15V dc 8.0 mA nominal @ 24V dc 12.0 mA max. @ 30V dc |
| Off Current | 2.5 mA max. | 1.5 mA max. |
| Nominal Impedance | 12K ohms @ 50 Hz 10K ohms @ 60 Hz | 3K ohms |
| Inrush Maximum | 250 mA max. ^① | Not Applicable |

^① To reduce the inrush maximum to 35 mA, apply a 6.8K ohm, 5w resistor in series with the input. The on-state voltage increases to 92V ac as a result.

DC Input Filter Settings

DC input filters are adjustable as shown below.

| Nominal Filter Setting (ms) | Minimum On Delay (ms) | Maximum On Delay (ms) | Minimum Off Delay (ms) | Maximum Off Delay (ms) |
|-----------------------------|-----------------------|-----------------------|------------------------|------------------------|
| 0.075 ^① | 0.009 | 0.075 | 0.009 | 0.075 |
| 0.10 ^① | 0.040 | 0.100 | 0.040 | 0.100 |
| 0.25 ^① | 0.147 | 0.250 | 0.147 | 0.250 |
| 0.50 | 0.014 | 0.500 | 0.014 | 0.500 |
| 1 | 0.091 | 1.000 | 0.091 | 1.000 |
| 2 | 0.618 | 2.000 | 0.618 | 2.000 |
| 4 | 2.441 | 4.000 | 2.441 | 4.000 |
| 8 | 6.256 | 8.000 | 6.256 | 8.000 |
| 16 | 13.37 | 16.00 | 13.37 | 16.00 |

^① Inputs 0 to 3 only.

AC Input Filter Settings

| Nominal Filter Setting (ms) ^① | Minimum ON Delay (ms) | Maximum ON Delay (ms) | Minimum OFF Delay (ms) | Maximum OFF Delay (ms) |
|--|-----------------------|-----------------------|------------------------|------------------------|
| 8.0 | 2.0 | 20.0 | 10.0 | 20.0 |

^① There is only one filter setting available for the AC inputs.

Output Specifications

| Description | Specification | | |
|-----------------------------------|--|---|------------------------------------|
| | Relay | MOSFET | Triac |
| Type | Relay | MOSFET | Triac |
| Voltage | 5 to 264V ac 5 to 125V dc | 20.4 to 26.4V dc | 85 to 264V ac |
| Maximum Load Current | Refer to the Relay Contact Rating Table. | 1.0A per point @ 55° C (131° F) 1.5A per point @ 30° C (86° F) | 0.5A per point |
| Minimum Load Current | 10.0 mA | 1 mA | 10.0 mA |
| Current per Controller | 1440 VA | 3A for L16BBB 6A for L32BBB | 1440 VA |
| Current per Common | 8.0A | 3A for L16BBB 6A for L32BBB | 2.5A |
| Maximum Off State Leakage Current | 0 mA | 1 mA | 2 mA @ 132V ac 4.5 mA @ 264V ac |
| Off to On Response | 10 ms max. | 0.1 ms | 8.8 ms @ 60 Hz 10.6 ms @ 50 Hz |
| On to Off Response | 10 ms max. | 1 ms | 11.0 ms |
| Surge Current per Point | Not Applicable | 3A for 10 ms ^① | 10A for 25 ms ^① |

^① Repeatability is once every 2 seconds at 55° C (131° F).

Relay Contact Rating Table

| Maximum Volts | Amperes | | Amperes Continuous | Volt-Amperes | |
|---------------|--------------------|-------|--------------------|--------------|--------|
| | Make | Break | | Make | Break |
| 240V ac | 7.5A | 0.75A | 2.5A | 1800 VA | 180 VA |
| 120V ac | 15A | 1.5A | | | |
| 125V dc | 0.22A ^① | | 1.0A | 28 VA | |
| 24V dc | 1.2A ^① | | 2.0A | 28 VA | |

^① For DC voltage applications, the make/break ampere rating for relay contacts can be determined by dividing 28 VA by the applied DC voltage. For example, $28 \text{ VA} \div 48 \text{ V dc} = 0.58 \text{ A}$. For DC voltage applications less than 48V, the make/break ratings for relay contacts cannot exceed 2A. For DC voltage applications greater than 48V, the make/break ratings for relay contacts cannot exceed 1A.

Hand-Held Programmer Specifications

| Description | Specification: 1761-HHP-B30 |
|---|---|
| Operating Power | 83 mA @ 24V dc |
| Operating Temperature | 0° C to 50° C (32° F to 122° F) |
| Storage Temperature | -20° C to 60° C (-4° F to 140° F) |
| Operating Humidity | 5 to 95% noncondensing |
| Certification (when product or packaging is marked) | <ul style="list-style-type: none"> • CSA certified • UL listed • CE marked for all applicable directives |
| Display Type | 2 x 16 LCD |
| Keypad | 30 Rubber/carbon Based Keys |

SLC 500 Fixed Controller

The SLC 500 Fixed Controller, which contains a processor, power supply, and I/O in a single package, offers a variety of low cost options with up to 104 predefined Input/Output (I/O) points. This controller also offers enhanced networking capabilities. For more information concerning I/O module compatibility options, refer to page 55.

Features

20, 30, or 40 I/O versions with 24 different I/O configurations.

Optional 2-slot expansion chassis

200 mA of 24V dc user power

Optional EEPROM or UV PROM backup memory

Selectable 8k Hz counter or normal DC input

Benefits

Provides a wide variety of fixed I/O configurations to meet your application requirements.

Allows for 64 additional I/O points or utilization of a wide range of specialty I/O modules.

Eliminates the need for an external power supply when using DC sensors.

Provides non-volatile storage of your ladder program.

Eliminates the added cost of a separate high speed counter module.

Specifications

The following table provides general specifications for the fixed controller.

| Description | Specification |
|---|--|
| Program Memory | 1K Instruction |
| Standard RAM | Capacitor – 2 weeks ^① Lithium Battery – 5 years ^② |
| Memory Back-up Options | EEPROM or UVPROM |
| Typical Scan Time | 8 ms/K |
| Hold-up Time (Load Dependent) | 20 ms to 700 ms |
| LED Indicators | RUN, CPU FAULT, FORCED I/O, BATTERY LOW |
| Programming | Advanced Programming Software, SLC 500 A.I. Series programming software, or the Hand-Held Terminal |
| Power Requirement (max.) | 50 VA |
| Noise Immunity | NEMA Standard ICS 2-230 |
| Fuse Protection 120/240V ac 24V dc | 1.25A 1.6A |
| Vibration (operating) | Displacement: .015 inch, peak-to-peak @ 5 - 57 Hz |
| | Acceleration: 2.5Gs at 57 - 2000 Hz |
| | Duration: 1 hr per axis (x,y,z) |
| Shock (operating) | 30Gs |
| Environmental conditions Operating temperature Storage temperature Humidity rating | 0° C to +60° C (+32° F to +140° F) -40° C to +85° C (-40° F to +185° F) 5 to 95% (non-condensing) |
| Wire Size | 24 AWG to 14 (max.) |
| Communication | DH-485 receive |
| Certification (when product or packaging is marked) | <ul style="list-style-type: none"> • CSA certified • UL listed |

^① 1747-L511 only – The capacitor back-up is rated at 35° C (95° F).

^② Lithium battery is optional for the L511; standard for the L514.

The following tables provide configuration options for 20, 30, or 40 I/O point units. To aid you in configuring your system with additional modules when using the optional 2-slot expansion chassis, refer to the Fixed Expansion Chassis Compatibility table on page 55.

| Catalog Number | I/O Configuration | Input | Output | Input Type | Output Type | Power Supply | High-Speed Counter | User Power | | | |
|----------------|-------------------|-----------------|-------------|--|-------------------|-----------------|--------------------|------------|-------------|-----|------------|
| 1747-L20A | 20 | 12 | 8 | 120V ac | Relay | 120/240V ac | No | - | | | |
| 1747-L20B | | | | | Triac | 120/240V ac | No | - | | | |
| 1747-L20C | | | | 24V dc Sinking | Relay | 120/240V ac | Yes | 24V-200 mA | | | |
| 1747-L20D | | | | | Triac | 120/240V ac | Yes | 24V-200 mA | | | |
| 1747-L20E | | | | | Transistor Source | 120/240V ac | Yes | 24V-200 mA | | | |
| 1747-L20F | | | | | Relay | 24V dc | Yes | - | | | |
| 1747-L20G | | | | | Transistor Source | 24V dc | Yes | - | | | |
| 1747-L20L | | | | | 24V dc Sourcing | Transistor Sink | 120/240V ac | Yes | 24V-200 mA | | |
| 1747-L20N | | | | Transistor Sink | | 24V dc | Yes | - | | | |
| 1747-L20P | | | | 240V ac | Triac | 120/240V ac | No | - | | | |
| 1747-L20R | | | | | Relay | 120/240V ac | No | - | | | |
| 1747-L30A | | | | 30 | 18 | 12 | 120V ac | Relay | 120/240V ac | No | - |
| 1747-L30B | | | | | | | | Triac | 120/240V ac | No | - |
| 1747-L30C | | | | | | | 24V dc Sinking | Relay | 120/240V ac | Yes | 24V-200 mA |
| 1747-L30D | Triac | 120/240V ac | Yes | | | | | 24V-200 mA | | | |
| 1747-L30L | 24V dc Sourcing | Transistor Sink | 120/240V ac | | | | Yes | 24V-200 mA | | | |
| 1747-L30P | 240V ac | Triac | 120/240V ac | | | | No | - | | | |
| 1747-L40A | 40 | 24 | 16 | 120V ac | Relay | 120/240V ac | No | - | | | |
| 1747-L40B | | | | | Triac | 120/240V ac | No | - | | | |
| 1747-L40C | | | | Relay | 120/240V ac | Yes | 24V-200 mA | | | | |
| 1747-L40E | | | | 24V dc Sinking | Transistor Source | 120/240V ac | Yes | 24V-200 mA | | | |
| 1747-L40F | | | | | Relay | 24V dc | Yes | - | | | |
| 1747-L40L | | | | 24V dc Sourcing | Transistor Sink | 120/240V ac | Yes | 24V-200 mA | | | |
| 1747-L40P | | | | 240V ac | Triac | 120/240V ac | No | - | | | |
| 1746-A2 | | | | 2-Slot Expansion Chassis (can only be used with the fixed hardware style configurations) | | | | | | | |

SLC 500 Modular Controller

The SLC 500 Modular Controller offers additional flexibility in system configuration, more processing power, and I/O capacity. By selecting the appropriate modular chassis, power supply, processor, and discrete or specialty I/O modules, you can create a controller system specifically designed for your application. Processor options include:

- SLC 5/01™ – 1K or 4K instructions processor (Catalog Number 1747-L511 or 1747-L514) with an instruction set identical to the SLC 500 fixed processor.
- SLC 5/02 – 4K processor (Catalog Number 1747-L524) with an enhanced instruction set.
- SLC 5/03 – 12K words and 4K additional data storage (Catalog Number 1747-L532) with flexible communications.
- SLC 5/04 – 12K, 28K, or 60K words and 4K of additional data words (Catalog Numbers 1747-L541, 1747-L542, or 1747-L543) with DH+ communications and speed exceeding the SLC 5/03 processor. Also, provides RS-232 or DH-485 selectability.

The instruction set is available on page [57](#) for your reference.

| Features | Benefits |
|---|---|
| Four central processing units | Supports a variety of I/O requirements and functionality. |
| Four different chassis sizes (4, 7, 10, and 13) | Provides I/O mounting flexibility and expansion options. |
| Variety of 1746 I/O modules | Provides over 48 different modules to meet your application needs. |
| Four power supplies | Supports AC and DC power, providing four different sizes. |
| Variety of communication options | Support of DH-485, RS-232, and DH+ communication. |
| Certification | UL listed, CSA approved Class I, Division 2 hazardous environment (exceptions indicated). CE marked for all applicable directives (exceptions indicated). |

The following table summarizes the detailed specifications for the SLC 500 processor family:

| Specification | SLC 5/01 (1747-L511, -L514) | SLC 5/02 (1747-L524) | SLC 5/03 (1747-L532) | SLC 5/04 | | |
|--------------------------------|-----------------------------------|---|-----------------------------|-----------------------------|-----------------------------|-----------------------------|
| | | | | 1747-L541 | 1747-L542 | 1747-L543 |
| Program Memory | 1K or 4K Instructions | 4K Instructions | 12K Words | 12K Words | 28K Words | 60K Words |
| Additional Data Storage | 0 | 0 | up to 4K Words | up to 4K Words | up to 4K Words | up to 4K Words |
| Max. Local I/O Capacity | 256 Discrete | 480 Discrete | 960 Discrete | 960 Discrete | 960 Discrete | 960 Discrete |
| Remote I/O | NA | Maximum number dependent on system power supply loading and program memory size. (4096 inputs and 4096 outputs maximum) | | | | |
| Max. Local Chassis/Slots | 3/30 | 3/30 | 3/30 | 3/30 | 3/30 | 3/30 |
| Programming | APS, SLC 500 A.I. Series, and HHT | APS, SLC 500 A.I. Series, and HHT | APS and SLC 500 A.I. Series | APS and SLC 500 A.I. Series | APS and SLC 500 A.I. Series | APS and SLC 500 A.I. Series |
| Programming Instructions | 52 | 71 | 99 | 99 | 99 | 99 |
| Typical Scan Time ^① | 8 ms/K | 4.8 ms/K | 1 ms/K | 0.9 ms/K | 0.9 ms/K | 0.9 ms/K |
| Bit Execution (XIC) | 4 μs | 2.4 μs | 0.44 μs | 0.37 μs | 0.37 μs | 0.37 μs |

^① The scan times are typical for a 1K ladder logic program consisting of simple ladder logic and communication servicing. Actual scan times depend on your program size, instructions used, and the communication protocol.

The following table summarizes the general specifications for the SLC 500 modular processors. Additional specifications are located on page 15.

| Description | Specification |
|--|---|
| Power Supply Loading at 5V dc | 350 mA for SLC 5/01, and SLC 5/02 processor |
| | 500 mA for the SLC 5/03 processor |
| | 1.0A for the SLC 5/04 processor |
| Power Supply Loading at 24V dc | 105 mA for SLC 5/01, and SLC 5/02 processor |
| | 175 mA for the SLC 5/03 processor |
| | 200 mA for the SLC 5/04 processor |
| Program Scan Hold-up Time after Loss of Power | 20 ms to 3s (dependent on power supply loading) |
| Clock/Calendar Accuracy (applicable only to SLC 5/03 and SLC 5/04 processors) | + or – 54 sec/month @ 25° C (77° F) + or – 81 sec/month @ 60° C (140° F) |
| Noise Immunity | NEMA Standard ICS 2-230 |
| Vibration | Displacement: 0.015 inch, peak-to-peak at 5–57 Hz |
| | Acceleration: 2.5Gs at 57–2000 Hz |
| Shock (operating) | 30Gs |
| Ambient Temperature Rating | Operating: 0 to + 60° C (32° F to 140° F) Storage: –40° C to 85° C (–40° F to 185° F) |
| Humidity | 5 to 95% without condensation |
| Certification (when product or packaging is marked) | <ul style="list-style-type: none"> • CSA certified • UL listed • Class 1, Groups A, B, C or D, Division 2 • CE marked for all applicable directives |

Communication Options

The following table summarizes the communication options for the SLC 500 processor family.

| Communication | Receive | Receive or Initiate |
|--|------------------------|---|
| DH-485 | SLC 5/01 | SLC 5/02, SLC 5/03, SLC 5/04 ^① |
| RS-232 (DF1 Full-Duplex, DF1 Half-Duplex Master/Slave, DH-485, or ASCII) | SLC 5/01 ^① | SLC 5/02 ^① , SLC 5/03 ^② , SLC 5/04 ^② |
| Data Highway Plus | SLC 5/01 ^{③④} | SLC 5/02 ^{③④} , SLC 5/03 ^③ , SLC 5/04 |

^① A 1747-PIC is required when connecting to the DH-485 channel.

^② You can connect channel 0 of the SLC 5/03 or SLC 5/04 processors to devices that support DH485 using the 1746-CP3 cable in a point-to-point connection. You can also connect channel 0 of the SLC 5/03 or SLC 5/04 processors to the 1746-PIC to make a connection to devices (SLC 5/01, SLC 5/02, SLC 5/03, and AIC link coupler) that support DH485.

^③ A 1785-KA5 is required.

^④ Receive is only through the 1785-KA5.

System Protection Options

The SLC 500 family of processors offer a number of hardware and software security features designed to help you protect your system from unauthorized changes to program or data files. The different types of protection are:

| Types of Protection | SLC 5/01 | SLC 5/02 | SLC 5/03 and SLC 5/04 |
|-----------------------------------|----------|----------|-----------------------|
| Password | • | • | • |
| Future Access (OEM Lock) | • | • | • |
| Program Owner | • | • | • |
| Program Files | NA | NA | • |
| Data Table Files | • | • | • |
| Memory Module Data File Overwrite | NA | NA | • |
| Memory Module Program Compare | NA | NA | • |
| Memory Module Write Protection | NA | NA | • |
| Force Protection | NA | NA | • |
| Keyswitch | NA | NA | • |
| Communication Channel Protection | NA | NA | • |

NA (Not Applicable)

Memory Modules

The following table summarizes the available memory back up options for the SLC 500 processors. EEPROM and UVPRM memory modules provide non-volatile memory back-up. Flash EPROMs (Flash Erasable Programmable Read Only Memory) combine the versatility of EEPROMs with the security of UVPRMs.

| Memory Back Up Option | SLC 5/01 (1747-L511, -L514) | SLC 5/02 (1747-L524) | SLC 5/03 (1747-L532) | SLC 5/04 | | |
|-----------------------|-----------------------------------|-------------------------|--------------------------------------|--------------------------------------|--------------------------------------|--------------------------------------|
| | | | | 1747-L541 | 1747-L542 | 1747-L543 |
| EEPROM | 1747-M1, 1747-M2 | 1747-M2 | NA | NA | NA | NA |
| UVPRM | 1747-M3, 1747-M4 | 1747-M4 | NA | NA | NA | NA |
| Flash | NA | NA | 1747-M11 1747-M12 (OS302 only) | 1747-M11 1747-M12 (OS401 only) | 1747-M11 1747-M12 (OS401 only) | 1747-M11 1747-M12 (OS401 only) |

NA (Not Applicable)

SLC 500 Family Specifications

The following specifications apply to all SLC 500 modular components.

| Description | Specification | Industry Standard |
|---|---|--|
| Temperature | Operating: 0° C to +60° C (32° F to 140° F) | Not Applicable |
| | Storage: -40° C to +85° C (-40° F to 185° F) | Not Applicable |
| Humidity | 5 to 95% without condensation | Not Applicable |
| Vibration | Operating: 1.0G @ 5 - 2000 Hz | Not Applicable |
| | Non-operating: 2.5Gs @ 5 - 2000 Hz | Not Applicable |
| Shock | Operating: (all modules except relay contact) 30.0Gs (3 pulses, 11 ms) | Not Applicable |
| | Operating: (relay contact modules - OW, IO combo) 10.0Gs (3 pulses, 11 ms) | Not Applicable |
| | Non-operating: 50.0Gs (3 pulses, 11 ms) | Not Applicable |
| Free Fall (drop test) | Portable, 2.268 kg (5 lbs) or less @ 0.762 m (30 in.) (six drops) | Not Applicable |
| | Portable, 2.268 kg (5 lbs) or more @ 0.1016 m (4 in.) (three flat drops) | Not Applicable |
| Electromagnetic Compatibility | Showering Arc: 1.5 KV | NEMA ICS 2-230/NEMA ICS 3-304 |
| | Surge Withstand Capability: 3 KV | IEEE Std. 472-1974/ANSI C37.90/90A-1974 |
| | Fast Transient Burst (impulse): 2KV for 1746 power supplies, 1KV for 1746 I/O and communication lines over 10m (32.84 ft), 5 ns rise time | Internal Allen-Bradley standard ^① |
| | Electrostatic Discharge (ESD): 15 KV, 100 pF/1.5 Kohm model | Internal Allen-Bradley standard ^① |
| | Radiated Electromagnetic Susceptibility: 5w walkie-talkie @ 464.5 MHz and 153.05 MHz | Internal Allen-Bradley standard ^① |
| Safety | Dielectric Withstand: 1500V ac | UL 508, CSA C22.2 No. 142 |
| | Isolation between Communication Circuits: 500V dc | Not Applicable |
| | Isolation between Backplane and I/Os: 1500V ac | Not Applicable |
| | Flammability and Electrical Ignition: UL94V-0 | Not Applicable |
| Certification (when product or packaging is marked) | <ul style="list-style-type: none"> • CSA certified • UL listed • Class 1, Groups A, B, C or D, Division 2 • CE marked for all applicable directives | Not Applicable |

^① Internal Allen-Bradley standards are based on Allen-Bradley's extensive experience in industrial controls. It is also based partly on industry and/or military specifications.

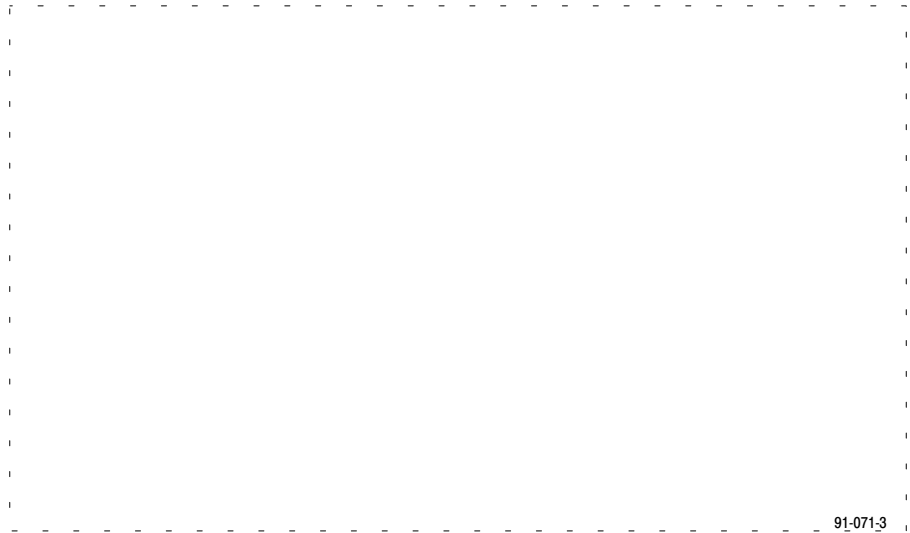

91-071-3

Power Supply Options

Allen-Bradley offers 4 different power supplies, three AC and one 24V dc. The AC supplies can be configured to operate using 120 or 240V ac.

| Description | 1746-P1 | 1746-P2 | 1746-P3 | 1746-P4 |
|--|---|---|--|---|
| Line Voltage | 85–132/170–265V ac 47–63 Hz | 85–132/170–265V ac 47–63 Hz | 19.2–28.8V dc | 85–132/170–265V ac 47–63 Hz |
| Typical Line Power Requirement | 135 VA | 180 VA | 90 VA | 240 VA |
| Maximum Inrush Current | 20A | 20A | 20A | 45A |
| Internal Current Capacity | 2A at 5V dc 0.46A at 24V dc | 5A at 5V dc 0.96A at 24V dc | 3.6A at 5V dc 0.87A at 24V dc | 10.0A at 5V dc 2.88A at 24V dc ^② |
| Fuse Protection ^① | 1746-F1 or equivalent: 250V-3A Fuse Nagasawa ULCS-61ML-3 or BUSSMANN AGC 3 | 1746-F2 or equivalent: 250V-3A Fuse SANO SOC SD4 or BUSSMANN AGC 3 | 1746-F3 or equivalent: 125V-5A Fuse Nagasawa ULCS-61ML-5 or BUSSMAN AGC 5 | Non-replaceable fuse is soldered in place. |
| 24V dc User Power Current Capacity | 200 mA | 200 mA | Not Applicable | 1A ^② |
| 24V dc User Power Voltage Range | 18–30V dc | 18–30V dc | Not Applicable | 20.4–27.6V dc |
| Ambient Operating Temperature Rating | 0° C to 60° C (32° F to 140° F) (Current capacity derated 5% above 55° C) | | | 0° C to 60° C (32° F to 140° F) no derating |
| Storage Temperature | –40° C to 85° C (–40° F to 185° F) | | | |
| Humidity Rating | 5–95% (non-condensing) | | | |
| Wiring | two 14 AWG wires per terminal (maximum) | | | |
| Certification (when product or packaging is marked) | <ul style="list-style-type: none"> • CSA certified • UL listed • CE marked for all applicable directives | | | |
| Hazardous Environment Certification | Class I Division 2 ^③ | | | |

^① Power supply fuse is intended to guard against fire hazard due to short circuit conditions and may not protect the supply from damage under overload conditions.

^② The combination of all output power (5 volt backplane, 24 volt backplane, and 24 volt user source) cannot exceed 70 Watts.

^③ The 1746-P4 power supply is certified for Class I Division 2 by CSA only.

Chassis Options

The chassis houses the processor and the I/O modules. There are four sizes of chassis that you can choose: 4-slot, 7-slot, 10-slot, and 13-slot. The power supply mounts on the left side of the chassis. All components easily slide into the chassis along guides formed in the chassis. No tools are required to insert or remove the processor or I/O modules.

Chassis can also be connected together to form a system (3 chassis maximum) by using one of two chassis interconnect cables. For chassis dimensions, refer to page 61.

| Catalog Number | Description |
|----------------|--|
| 1746-A4 | 4-Slot Chassis |
| 1746-A7 | 7-Slot Chassis |
| 1746-A10 | 10-Slot Chassis |
| 1746-A13 | 13-Slot Chassis |
| 1746-C7 | 152.4 mm (6 in.) Chassis Interconnect Cable – This ribbon cable is used when linking modular hardware style chassis up to 152.4 mm (6 in.) apart in an enclosure. |
| 1746-C9 | 914.4 mm (36 in.) Chassis Interconnect Cable – This cable is used when linking modular hardware style chassis from 152.4 mm (6 in.) up to 914.4 mm (36 in.) apart in an enclosure. |

1746 Discrete I/O Modules

The 1746 I/O platform is a modular hardware design that uses a cost and space effective means to add I/O modules to your control system. I/O modules are available in a variety of densities including 4, 8, 16, and 32 point and can interface to AC, DC, and TTL voltage levels.

Features

High density 32-point and combination modules

High current relay contact and solid-state output modules

Removable terminal blocks on 16-point modules

Industrial design

Benefits

Reduces rack size and panel space requirements.

Eliminates the need for interfacing relays for switching loads.

Provides ease of wiring and module replacement.

Provides input filtering and optical isolation for exceptional reliability in industrial applications.

1746 Discrete Input Modules

| Voltage Category | Operating Voltage (Volts) | Number of Inputs | Points Per Common | Catalog Number | Backplane Current Draw (Amps) | | Signal Delay (ms. max) | Off-State Current (max.) | |
|------------------|---|--------------------|-------------------|------------------------------------|------------------------------------|-------|--|--------------------------|--------|
| | | | | | 5 V | 24 V | | | |
| 100/120V ac | 85-132 | 4 | 4 | 1746-IA4 | 0.035 | 0 | on=35 off=45 | 2 mA | |
| | 85-132 | 8 | 8 | 1746-IA8 | 0.050 | 0 | on=35 off=45 | 2 mA | |
| | 85-132 | 16 | 16 | 1746-IA16 (RTB) | 0.085 | 0 | on=35 off=45 | 2 mA | |
| 200/240V ac | 170-265 | 4 | 4 | 1746-IM4 | 0.035 | 0 | on=35 off=45 | 2 mA | |
| | 170-265 | 8 | 8 | 1746-IM8 | 0.050 | 0 | on=35 off=45 | 2 mA | |
| | 170-265 | 16 | 16 | 1746-IM16 (RTB) | 0.085 | 0 | on=35 off=45 | 2 mA | |
| 24V ac/DC | 10-30 DC sink 10-30 AC | 16 | 16 | 1746-IN16 (RTB) | 0.085 | 0 | on=15 DC off=15 DC on=25 AC off=25 AC | 1 mA AC & DC | |
| 24V dc | 10-30 sink | 8 | 8 | 1746-IB8 | 0.050 | 0 | on=8 off=8 | 1 mA | |
| | 10-30 sink | 16 | 16 | 1746-IB16 (RTB) | 0.085 | 0 | on=8 off=8 | 1 mA | |
| | 15-30 at 50° C (122° F) 15-26.4 at 60° C (140° F) sink | 32 | 8 | 1746-IB32^{①②} | 0.106 | 0 | on=3 off=3 | 1.6 mA | |
| | 10-30 sink | 16 (Fast Response) | 16 | 1746-ITB16 (RTB) | 0.085 | 0 | on=0.3 off=0.5 | 1.5 mA | |
| | 10-30 source | 8 | 8 | 1746-IV8 | 0.050 | 0 | on=8 off=8 | 1 mA | |
| | 10-30 source | 16 | 16 | 1746-IV16 (RTB) | 0.085 | 0 | on=8 off=8 | 1 mA | |
| | 10-30 source | 16 (Fast Response) | 16 | 1746-ITV16 (RTB) | 0.085 | 0 | on=0.3 off=0.5 | 1.5 mA | |
| | 15-30 at 50° C (122° F) 15-26.4 at 60° C (140° F) source | 32 | 8 | 1746-IV32^{①②} | 0.106 | 0 | on=3 off=3 | 1.6 mA | |
| 48 V dc | 30-60 at 55° C (122° F) 30-55 at 60° C (140° F) sink | 16 | 16 | 1746-IC16^③ (RTB) | 0.085 | 0 | on=4 off=4 | 1.5 mA | |
| 5 | TTL | 4.5-5.5 source | 16 | 16 | 1746-IG16^④ (RTB) | 0.140 | 0 | on=0.25 off=0.50 | 4.1 mA |

① Certified for Class I, Division 2 hazardous location by CSA only.

② Ribbon cable connector. User must construct cable or purchase 1492-series pre-wired cable.

③ Use ID code 0509 when configuring your system with your programming software or the Hand-Held Terminal.

④ This product does not have CE certification.

RTB = Removable Terminal Block.

1746 Discrete Output Modules

| Voltage Category | Operating Voltage (Volts) | Number of Outputs | Points Per Common | Catalog Number | Backplane Current Draw (Amps) | | Signal Delay (ms. max) | Off State Leakage (max.) | Load Current at 5V dc (min.) | Continuous Current per Point (max.) | Continuous Current per Module (max.) |
|------------------|---------------------------|-------------------|-------------------|-----------------------------------|-------------------------------|------|--------------------------|--------------------------|------------------------------|--|---|
| | | | | | 5 V | 24 V | | | | | |
| 120/ 240V ac | 85-265 | 8 | 4 | 1746-OA8 | 0.185 | 0 | on=1.0 off=11.0 | 2 mA | 10 mA | 1A at 30° C (86° F) 0.50A at 60° C (140° F) | 8A at 30° C (86° F) 4A at 60° C (140° F) |
| | 85-265 | 16 | 8 | 1746-OA16 (RTB) | 0.370 | 0 | on=1.0 off=11.0 | 2 mA | 10 mA | 0.50A at 30° C (86° F) 0.25A at 60° C (140° F) | 8A at 30° C (86° F) 4A at 60° C (140° F) |
| | 85-265 | 12 | 6 | 1746-OAP12 ^{①②} (RTB) | 0.370 | 0 | on=1.0 off=11.0 | 2 mA | 10 mA | 2.0A at 30°C (86° F) 1.25A at 55°C (122° F) 1.0A at 60°C (140° F) | 9.0A at 30°C (86° F) 6.0A at 60°C (140° F) |
| 24V dc | 10-50 source | 8 | 8 | 1746-OB8 | 0.135 | 0 | on=0.10 off=1.0 | 1 mA | 1 mA | 1A at 30° C (86° F) 0.50A at 60° C (140° F) | 8A at 30° C (86° F) 4A at 60° C (140° F) |
| | 10-50 source | 16 | 16 | 1746-OB16 (RTB) | 0.280 | 0 | on=0.10 off=1.0 | 1 mA | 1 mA | 0.50A at 30° C (86° F) 0.25A at 60° C (140° F) | 8A at 30° C (86° F) 4A at 60° C (140° F) |
| | 20.4-26.4 source | 8 | 4 | 1746-OBP8 ^② (RTB) | 0.135 | 0 | on=1.0 off=2.0 | 1 mA | 1 mA | 2.0A at 60° C (140° F) | 8.0A at 60° C (140° F) |
| | 20.4-26.4 source | 16 | 16 | 1746-OBP16 ^{①③} (RTB) | 0.250 | 0 | on=0.10 off=1.0 | 1 mA | 1 mA | 1.5A at 30° C (86° F) 1.0A at 60° C (140° F) | 6.4A at 0° to 60° C (140° F) |
| | 5-50 source | 32 | 16 | 1746-OB32 ^{③④} | 0.452 | 0 | on=0.10 off=1.0 | 1 mA | 1 mA | 0.1A at 60° C (140° F) | 3.2A at 60° C (140° F) |
| | 10-50 sink | 8 | 8 | 1746-OV8 | 0.135 | 0 | on=0.10 off=1.0 | 1 mA | 1 mA | 1A at 30° C (86° F) 0.50A at 60° C (140° F) | 8A at 30° C (86° F) 4A at 60° C (140° F) |
| | 10-50 sink | 16 | 16 | 1746-OV16 (RTB) | 0.270 | 0 | on=0.10 off=1.0 | 1 mA | 1 mA | 0.50A at 30° C (86° F) 0.25A at 60° C (140° F) | 8A at 30° C (86° F) 4A at 60° C (140° F) |
| | 20.4-26.4 sink | 16 | 16 | 1746-OVP16 ^{①③} | 0.250 | 0 | on=0.10 ms off=1.0 ms | 1 mA | 1 mA | 1.5A at 30° C (86° F) 1.0A at 60° C (140° F) | 6.4A at 0° to 60° C (140° F) |
| | 5-50 sink | 32 | 16 | 1746-OV32 ^{③④} | 0.452 | 0 | on=0.10 off=1.0 | 1 mA | 1 mA | 0.1A at 60° C (140° F) | 3.2A at 60° C (140° F) |
| 5 TTL | 4.5-5.5 sink | 16 | 16 | 1746-OG16 ^⑤ (RTB) | 0.180 | 0 | on=0.25 off=0.50 | 0.10 mA | 0.15 mA | 0.024A | Not applicable |

Continued on following page

| Voltage Category | Operating Voltage (Volts) | Number of Outputs | Points Per Common | Catalog Number | Backplane Current Draw (Amps) | | Signal Delay (ms. max) | Off State Leakage (max.) | Load Current at 5V dc (min.) | Continuous Current per Point (max.) | Continuous Current per Module (max.) |
|------------------|---------------------------|-------------------|-----------------------|---------------------------------|-------------------------------|-------|------------------------|--------------------------|------------------------------|-------------------------------------|--------------------------------------|
| | | | | | 5 V | 24 V | | | | | |
| V ac/V dc Relay | 5-265V ac 5-125V dc | 4 | 4 | 1746-OW4 ^③ | 0.045 | 0.045 | on=10.0 off=10.0 | 0 mA | 10 mA | see relay chart | 8.0A 8.0A/common ^⑥ |
| | 5-265V ac 5-125V dc | 8 | 4 | 1746-OW8 ^③ | 0.085 | 0.090 | on=10.0 off=10.0 | 0 mA | 10 mA | see relay chart | 16.0A 8.0A/common ^⑥ |
| | 5-265V ac 5-125V dc | 16 | 8 | 1746-OW16 ^③ (RTB) | 0.170 | 0.180 | on=10.0 off=10.0 | 0 mA | 10 mA | see relay chart | 16.0A 8.0A/common ^⑥ |
| | 5-265V ac 5-125V dc | 8 | individually isolated | 1746-OX8 ^③ (RTB) | 0.085 | 0.090 | on=10.0 off=10.0 | 0 mA | 10 mA | see relay chart | ⑥ |

① A fused common and blown fuse LED are provided on this module.

② Use the following ID codes when configuring your system with your programming software or the Hand-held Terminal: 1746-OBP8 = 2721 and 1746-OAP12 = 2803.

③ Certified for Class I, Division 2 hazardous location by CSA only.

④ Ribbon cable connector. User must construct cable or purchase 1492-series pre-wired cable.

⑤ This product does not have CE certification.

⑥ The continuous current per module must be limited to 1440 VA (max.).

Relay Contact Rating Chart

| Type | Max. Volts | Amperes ^① | | Amps Continuous ^③ | Volt-Amperes | | Type | Max. Volts | Amperes | | Amps Continuous | Volt-Amperes | |
|--|--------------------|----------------------|----------------|------------------------------|--------------|--------|-------------------------------|--------------------|----------------|--------------|-----------------|--------------|--------|
| | | Make | Break | | Make | Break | | | Make | Break | | Make | Break |
| Relay Contact Ratings for OW4, OW8, and OW16 | 240V ac 120V ac | 7.5A 15.0A | 0.75A 1.50A | 2.5A | 1800 VA | 180 VA | Relay Contact Ratings for OX8 | 240V ac 120V ac | 15.0A 30.0A | 1.5A 3.0A | 5.0A | 3600 VA | 360 VA |
| | 125V dc | 0.22A ^② | | 1.0A | 28 VA | | | 125V dc | 0.22A | | 1.0A | 28 VA | |
| | 24V dc | 1.2A ^② | | 2.0A | 28 VA | | | 24V dc | 1.2A | | 2.0A | 28 VA | |

① Connecting surge suppressors across your external load will extend the life of SLC 500 relay contacts. For relay contact outputs, consult the SLC 500 Installation and Operation User Manual (Catalog Number 1747-6.2).

② For DC voltage applications, the make/break ampere rating for relay contacts can be determined by dividing 28 VA by the applied DC voltage. For example, 28 VA/48V dc = 0.58A. For DC voltage applications less than 48V, the make/break ratings for relay contacts cannot exceed 2A. For DC voltage applications greater than 48V, the make/break ratings for relay contacts cannot exceed 1A.

③ The continuous current per module must be limited so the module power does not exceed 1440 VA.

1746 Discrete Combination Modules

| Voltage Category | Operating Voltage | Points Per Module | Points Per Common | Catalog Number | Backplane Current Draw (Amps) | | Specification Reference |
|------------------------------|------------------------|-----------------------|-------------------|-------------------------|-------------------------------|-------|--|
| | | | | | 5 V | 24 V | |
| Inputs-120V ac | 85-132V ac | 2 inputs 2 outputs | 2 | 1746-IO4 ^{①②} | 0.030 | 0.025 | See specifications for Catalog Numbers 1746-IA4 and 1746-OW4 Continuous Current for IO4 is 4.0A Continuous Current for IO8 is 8.0A |
| Relay Outputs 100/120V ac | 5-265V ac 5-125V dc | 4 inputs 4 outputs | 4 | 1746-IO8 ^{①②} | 0.060 | 0.045 | |
| | | 6 inputs 6 outputs | 6 | 1746-IO12 ^{①②} | 0.090 | 0.070 | See specifications for Catalog Numbers 1746-IA16 and OW16 Continuous Current for IO12 is 8.0A |

① Certified for Class I, Division 2 hazardous location by CSA only.

② This product does not have CE certification.

Bulletin 1492 Interface Modules and Cables

Allen-Bradley's new wiring system for programmable controllers reduces installation time and increases start-up success. Comprised of a Bulletin 1492 Interface Module and a pre-wired cable, this wiring system can eliminate up to 50 percent of the point-to-point wiring between the programmable controller and field devices. Available for many of the SLC 500 and PLC[®] 16- and 32-point I/O modules, the wiring system provides a lower probability for wiring errors. Optional LEDs on the Interface Module indicate the on/off status of input and output devices, aiding in troubleshooting your wiring system. For more information refer to Publication 1492-1.6.

Specialty I/O Modules

The SLC 500 family offers specialty I/O modules that enhance your control system. These modules range from analog, motion control, and communication to provide a unique, easy to use interface between the modules and the processor. The following section provides an overview of our specialty I/O modules.

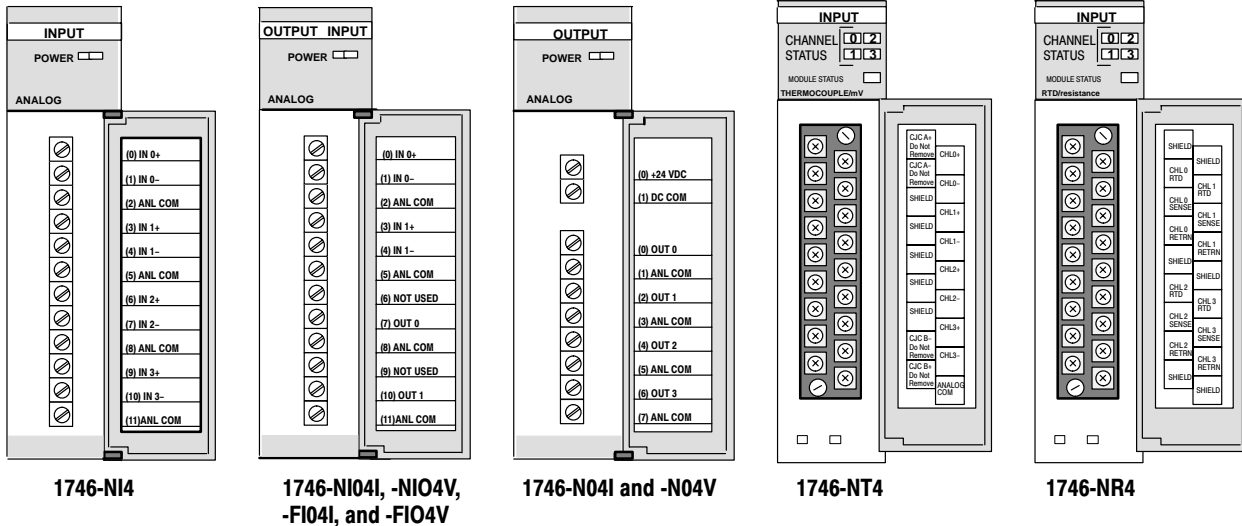

1746 I/O Analog Modules

The SLC 500 family offers nine different analog I/O modules for your control applications.

- NI4 input module
- NIO4I, NIO4V, FIO4I, and FIO4V input/output modules
- NO4I and NO4V output modules
- NT4 Thermocouple/mV input module
- NR4 RTD/resistance input module

Features

- High resolution
- Backplane powered
- User selectable inputs
- Input filtering
- Image maps directly into the SLC™ image

Benefits

- 12-bit input for the FIO4I and FIO4V and 16-bit input for NI4, NIO4I, and NIO4V. 14-bit output converters on all the modules provide accurate control capabilities.
- No external power supply required, reducing system cost.
- Configurable per channel.
- Provides higher immunity to electrical noise (Nxxx) or a faster input response (Fxxx) modules.
- Saves memory usage and time.

The following pages provides individual module specifications.

| Catalog Number 1746- | Input Channels per Module | Output Channels per Module | Backplane Current Draw | External 24V dc Power Supply Tolerance |
|-------------------------|---|---|------------------------------------|--|
| NI4 | 4 differential, voltage or current selectable per channel | Not applicable | 25 mA at 5V dc 85 mA at 24V dc | Not Applicable |
| NIO4I | 2 differential, voltage or current selectable per channel | 2 current outputs not individually isolated | 55 mA at 5V dc 145 mA at 24V dc | Not Applicable |
| NIO4V | 2 differential, voltage or current selectable per channel | 2 voltage outputs, not individually isolated | 55 mA at 5V dc 115 mA at 24V dc | Not Applicable |
| NO4I | Not applicable | 4 current outputs, not individually isolated | 55 mA at 5V dc 195 mA at 24V dc | 24 ±10% at 195 mA (21.6 to 26.4V dc) |
| NO4V | Not applicable | 4 voltage outputs, not individually isolated | 55 mA at 5V dc 145 mA at 24V dc | 24 ±10% at 145 mA (21.6 to 26.4V dc) |
| FIO4I | 2 differential, voltage or current selectable per channel | 2 current outputs, not individually isolated | 55 mA at 5V dc 150 mA at 24V dc | Not Applicable |
| FIO4V | 2 differential, voltage or current selectable per channel | 2 voltage outputs, not individually isolated | 55 mA at 5V dc 120 mA at 24V dc | Not Applicable |

Important: All analog modules are isolated from each other and from the backplane. If the NO4I or the NO4V is externally powered, the 24V dc backplane current draw is 0 mA.

Specifications

The specifications for the analog modules are the same as shown in the *Specifications* on page 15 for the modular controller, with the following additions:

| Description | Specification |
|---|--|
| SLC Communication Format | 16-bit Two's Complement Binary |
| Field Wiring to Backplane Isolation | 500V dc |
| Conversion Time | 512 μ s for all channels in parallel |
| Current/Voltage Ranges | |
| NI4 | \pm 10V dc or \pm 20 mA (input) |
| NIO4I | \pm 10V dc or \pm 20 mA (input), 0 to 21 mA (output) |
| NIO4V | \pm 10V dc or \pm 20 mA (input), \pm 10V dc (output) |
| NO4I | 0 to 21 mA (current output) |
| NO4V | \pm 10 V (voltage output) |
| FIO4I | 0 to 10V or 0 to 21 mA (input), 0 to 21 mA (output) |
| FIO4V | 0 to 10V or 0 to 21 mA (input), \pm 10V (output) |
| Step Response (NI4, NIO4I, NIO4V, NO4I, and NO4V) | |
| Input | 60 ms at 95% |
| Output | 2.5 ms at 95% |
| Step Response (FIO4I, FIO4V) | |
| Input | 100 μ s at 95% |
| Output | 2.5 ms at 95% |
| Maximum Wire Size | 14 AWG |
| Terminal Block | Removable |
| Recommended Cable | Belden #8761 |
| Input A/D Converter (NI4, NIO4I, NIO4V, NO4I, and NO4V) | 16-bit |
| Input A/D Converter (FIO4I, FIO4V) | 12-bit |

1746-NT4 Thermocouple/mV Module

The thermocouple/mV module receives and stores digitally converted thermocouple and/or DC millivolt (mV) analog data into its image table for retrieval by all fixed and modular SLC 500 processors.

Features

Cold-junction compensation and linearization

Four selectable filters

Individual channel configuration

Benefits

Provides accurate process digital temperature readings.

Allows you to tailor system response to your environment.

Allows you to mix millivolt and thermocouple types.

The 1746-NT4 module converts input signals from the following input types.

Thermocouple Temperature Ranges

| Type of Thermocouple Input | ° C Temperature Range | ° F Temperature Range | Accuracy (Max. error at 25° C/77° F) |
|----------------------------|-----------------------|-----------------------|---|
| Type J | -210° C to 760° C | -346° F to 1400° F | ±1.06° C |
| Type K | -270° C to 1370° C | -454° F to 2498° F | ±1.72° C |
| Type T | -270° C to 400° C | -454° F to 752° F | ±1.43° C |
| Type E | -270° C to 1000° C | -454° F to 1832° F | ±0.72° C |
| Type N | 0° C to 1300° C | 32° F to 2372° F | ±1.39° C |
| Type R | 0° C to 1768° C | 32° F to 3214° F | ±3.59° C |
| Type S | 0° C to 1768° C | 32° F to 3214° F | ±3.61° C |
| Type B | 300° C to 1820° C | 572° F to 3308° F | ±3.12° C |

DC Millivolt Input Ranges

| Millivolt Input Type | Range | Accuracy (Max. error at 25° C/77° F) |
|----------------------|--------------------------|---|
| ± 50 mV | -50 mV dc to +50 mV dc | 50 µV |
| ± 100 mV | -100 mV dc to +100 mV dc | 50 µV |

Specifications

The specifications for the Thermocouple/mV module are the same as shown in the *Specifications* on page 15 for the modular controller, with the following additions:

| Specification | Description |
|---|---|
| Backplane Current Draw 5V dc 24V dc | 60 mA 40 mA |
| Temperature Scale Resolution (selectable) | ° C of ° F and 0.1° C or 0.1° F |
| Millivolt Scale Resolution (selectable) | 0.1 millivolt and 0.01 millivolt (mV) |
| Open Circuit Method | Upscale |
| Input Step Response | 300 ms at 10 Hz 60 ms at 50 Hz 50 ms at 60 Hz 12 ms at 250 Hz |
| Thermocouple Linearization | IPTS-68 standard, NBS MN-125, NBS MN-161 |
| Maximum Cable Impedance | 25 ohms max. loop impedance for <1LSB error |
| Calibration | Autocalibration at power-up and when a channel is enabled. |
| Isolation | 500V dc continuous between inputs and chassis ground, and between inputs and backplane. |
| Isolation between channels | None. |
| Maximum Channel-to-Channel Common-mode Separation | 2V maximum between any two channels (Series B) ^① |
| Recommended Cable for thermocouple inputs for mV inputs | Appropriate shielded thermocouple extension wire ^② Belden #8761 or equivalent (shielded twisted pair) |
| Maximum Wire Size | Two 14 AWG wires per terminal |

^① Allows use with a single or multiple grounded thermocouples as long as the grounds are within 2 volts of each other. Series A modules offer zero volts separation and can be used with a single grounded thermocouple. Both Series A or B can be used with multiple ungrounded thermocouples.

^② Refer to the thermocouple manufacturer for the correct extension wire.

1746-NR4 RTD/resistance Input Module

The RTD/resistance input module enhances the present temperature control capabilities of your SLC 500 fixed or modular system by providing the capability to interface with 12 different RTDs and 4 different direct resistance ranges. RTDs are known for their accuracy, repeatability, linearity, and long-term stability.

Features

Module interface compatibility with a number of different RTDs

Two selectable excitation current levels (0.5 and 2.0 mA)

Four selectable filters

Individual channel configuration

Benefits

Allows you to choose the best RTD for your temperature application.

Provides capability to limit RTD self heating and to provide greater temperature accuracy.

Allows you to tailor system response to your environment.

Allows you to mix RTD and resistance device types.

RTD Temperature Ranges, Resolution, and Repeatability

| RTD Type | | Temp. Range (0.5 mA Excitation) ^① | Temp. Range (2.0 mA Excitation) ^① | Resolution | Repeatability |
|---------------------------------|-------|---|---|--------------------|----------------------|
| Platinum (385) ^② | 100Ω | -200° C to +850° C (-328° F to +1562° F) | -200° C to +850° C (-328° F to +1562° F) | 0.1° C (0.2° F) | ±0.2° C (±0.4° F) |
| | 200Ω | -200° C to +850° C (-328° F to +1562° F) | -200° C to +850° C (-328° F to +1562° F) | 0.1° C (0.2° F) | ±0.2° C (±0.4° F) |
| | 500Ω | -200° C to +850° C (-328° F to +1562° F) | -200° C to +850° C (-328° F to +1562° F) | 0.1° C (0.2° F) | ±0.2° C (±0.4° F) |
| | 1000Ω | -200° C to +850° C (-328° F to +1562° F) | -200° C to +240° C (-328° F to +464° F) | 0.1° C (0.2° F) | ±0.2° C (±0.4° F) |
| Platinum (3916) ^② | 100Ω | -200° C to +630° C (-328° F to +1166° F) | -200° C to +630° C (-328° F to +1166° F) | 0.1° C (0.2° F) | ±0.2° C (±0.4° F) |
| | 200Ω | -200° C to +630° C (-328° F to +1166° F) | -200° C to +630° C (-328° F to +1166° F) | 0.1° C (0.2° F) | ±0.2° C (±0.4° F) |
| | 500Ω | -200° C to +630° C (-328° F to +1166° F) | -200° C to +630° C (-328° F to +1166° F) | 0.1° C (0.2° F) | ±0.2° C (±0.4° F) |
| | 1000Ω | -200° C to +630° C (-328° F to +1166° F) | -200° C to +230° C (-328° F to +446° F) | 0.1° C (0.2° F) | ±0.2° C (±0.4° F) |
| Copper (426) ^{②③} | 10Ω | Not Allowed ^④ | -100° C to +260° C (-148° F to +500° F) | 0.1° C (0.2° F) | ±0.2° C (±0.4° F) |
| Nickel (618) ^{②⑤} | 120Ω | -100° C to +260° C (-148° F to +500° F) | -100° C to +260° C (-148° F to +500° F) | 0.1° C (0.2° F) | ±0.1° C (±0.2° F) |
| Nickel (672) ^{②⑥} | 120Ω | -80° C to +260° C (-112° F to +500° F) | -80° C to +260° C (-112° F to +500° F) | 0.1° C (0.2° F) | ±0.1° C (±0.2° F) |
| Nickel Iron (518) ^{②⑥} | 604Ω | -100° C to +200° C (-148° F to +392° F) | -100° C to +200° C (-148° F to +392° F) | 0.1° C (0.2° F) | ±0.1° C (±0.2° F) |

^① The temperature range for the 1000Ω RTD is dependant on the excitation current.

^② The digits following the RTD type represent the temperature coefficient of resistance (α), which is defined as the resistance change per ohm per ° C. For instance, *Platinum 385* refers to a platinum RTD with $\alpha = 0.00385$ ohms/ohm -° C or simply 0.00385 /° C.

^③ Actual value at 0° C (32° F) is 9.042Ω per SAMA standard RC21-4-1966.

^④ To maximize the relatively small RTD signal, only 2 mA excitation current is allowed.

^⑤ Actual value at 0° C (32° F) is 100Ω per DIN standard.

^⑥ Minco Type 'NA' (Nickle) and Minco Type 'FA' (Nickle-Iron)

RTD Accuracy and Temperature Drift Specifications

| RTD Type | | Accuracy ^① (0.5 mA Excitation) | Accuracy ^① (2.0 mA Excitation) | Temperature Drift ^② (0.5 mA Excitation) | Temperature Drift ^② (2.0 mA Excitation) |
|--------------------------------|-------|--|--|---|---|
| Platinum (385) ^④ | 100Ω | ±1.0° C ^③ (±2.0° F) | ±0.5° C (±0.9° F) | ±0.034° C/° C (±0.061° F/° F) | ±0.014° C/° C (±0.025° F/° F) |
| | 200Ω | ±1.0° C ^③ (±2.0° F) | ±0.5° C (±0.9° F) | ±0.034° C/° C (±0.061° F/° F) | ±0.014° C/° C (±0.025° F/° F) |
| | 500Ω | ±0.6° C (±1.1° F) | ±0.5° C (±0.9° F) | ±0.017° C/° C (±0.031° F/° F) | ±0.014° C/° C (±0.025° F/° F) |
| | 1000Ω | ±0.6° C (±1.1° F) | ±0.5° C (±0.9° F) | ±0.017° C/° C (±0.031° F/° F) | ±0.014° C/° C (±0.025° F/° F) |
| Platinum (3916) ^④ | 100Ω | ±1.0° C ^③ (±2.0° F) | ±0.4° C (±0.7° F) | ±0.034° C/° C (±0.061° F/° F) | ±0.011° C/° C (±0.020° F/° F) |
| | 200Ω | ±1.0° C ^③ (±2.0° F) | ±0.4° C (±0.7° F) | ±0.034° C/° C (±0.061° F/° F) | ±0.011° C/° C (±0.020° F/° F) |
| | 500Ω | ±0.5° C (±0.9° F) | ±0.4° C (±0.7° F) | ±0.014° C/° C (±0.025° F/° F) | ±0.011° C/° C (±0.020° F/° F) |
| | 1000Ω | ±0.5° C (±0.9° F) | ±0.4° C (±0.7° F) | ±0.014° C/° C (±0.025° F/° F) | ±0.011° C/° C (±0.020° F/° F) |
| Copper (426) ^{④⑤} | 10Ω | Not Allowed ^⑥ | ±0.6° C (±1.1° F) | Not Allowed ^⑥ | ±0.017° C/° C (±0.031° F/° F) |
| Nickel (618) ^{④⑦} | 120Ω | ±0.2° C (±0.4° F) | ±0.2° C (±0.4° F) | ±0.008° C/° C (±0.014° F/° F) | ±0.008° C/° C (±0.014° F/° F) |
| Nickel (672) ^④ | 120Ω | ±0.2° C (±0.4° F) | ±0.2° C (±0.4° F) | ±0.008° C/° C (±0.014° F/° F) | ±0.008° C/° C (±0.014° F/° F) |
| Nickel Iron (518) ^④ | 604Ω | ±0.3° C (±0.5° F) | ±0.3° C (±0.5° F) | ±0.010° C/° C (±0.018° F/° F) | ±0.010° C/° C (±0.018° F/° F) |

① The accuracy values assume that the module was calibrated within the specified temperature range of 0° C to 60° C (32° F to 140° F).

② Temperature drift specifications apply to a module that has not been calibrated.

③ Module accuracy, using 100Ω or 200Ω platinum RTDs with 0.5 mA excitation current, depends on the following criteria:

(a) Module accuracy is ±0.6° C after you apply power to the module or perform an autocalibration at 25° C (77° F) ambient with module operating temperature at 25° C (77° F).

(b) Module accuracy is $\pm(0.6^\circ\text{C} + \Delta T \times 0.034^\circ\text{C}/^\circ\text{C})$ after you apply power to the module or perform an autocalibration at 25° C (77° F) ambient with the module operating temperature between 0° C to 60° C (32° F to 140° F).

—where ΔT is the temperature difference between the actual operating temperature of the module and 25° C (77° F) and 0.034° C/° C is the temperature drift shown in the table above for 100Ω or 200Ω platinum RTDs.

(c) Module accuracy is ±1.0° C after you apply power to the module or perform an autocalibration at 60° C (140° F) ambient with module operating temperature at 60° C (140° F).

④ The digits following the RTD type represent the temperature coefficient of resistance (α), which is defined as the resistance change per ohm per °C. For instance, *Platinum 385* refers to a platinum RTD with $\alpha = 0.00385$ ohms/ohm -°C or simply 0.00385 / °C.

⑤ Actual value at 0° C (32° F) is 9.042Ω per SAMA standard RC21-4-1966.

⑥ To maximize the relatively small RTD signal, only 2 mA excitation current is allowed.

⑦ Actual value at 0° C (32° F) is 100Ω per DIN standard.

Resistance Input Specifications

| Input Type | Resistance Range (0.5 mA Excitation) | Resistance Range (2.0 mA Excitation) | Accuracy ^① | Temperature Drift | Resolution | Repeatability | |
|------------|--------------------------------------|--------------------------------------|-----------------------|-------------------|----------------------------|---------------|--------|
| Resistance | 150Ω | 0Ω to 150Ω | 0Ω to 150Ω | ^② | ^③ | 0.01Ω | ±0.04Ω |
| | 500Ω | 0Ω to 500Ω | 0Ω to 500Ω | ±0.5Ω | ±0.014Ω/°C (±0.025Ω/°F) | 0.1Ω | ±0.2Ω |
| | 1000Ω | 0Ω to 1000Ω | 0Ω to 1000Ω | ±1.0Ω | ±0.029Ω/°C (±0.052Ω/°F) | 0.1Ω | ±0.2Ω |
| | 3000Ω | 0Ω to 3000Ω | 0Ω to 1900Ω | ±1.5Ω | ±0.043Ω/°C (±0.077Ω/°F) | 0.1Ω | ±0.2Ω |

^① The accuracy values assume that the module was calibrated within the specified temperature range of 0° C to 60° C (32° F to 140° F).

^② The accuracy for 150Ω is dependant on the excitation current:

±0.2Ω at 0.5 mA

±0.15Ω at 2.0 mA

^③ The temperature drift for 150Ω is dependant on the excitation current:

±0.006Ω/°C at 0.5 mA

±0.004Ω at 2.0 mA

Specifications

The specifications for the RTD/resistance input module are the same as shown in the *Specifications* on page 15 for the modular controller, with the following additions:

| Specification | Description |
|---|---|
| Backplane Current Draw 5V dc 24V dc | 50 mA 50 mA |
| Temperature Scale Resolution (selectable) | 1° C or 1° F and 0.1° C or 0.1° F |
| Resistance Scale Resolution (selectable) | 1Ω or 0.1Ω for all resistance ranges. In addition, 0.01Ω for 150Ω range. |
| RTD Excitation Current | Two current values are user-selectable (0.5 mA and 2.0 mA) ^① |
| Open circuit or short circuit Method | Zero, upscale or downscale |
| Input Step Response | 300 ms at 10 Hz 60 ms at 50 Hz 50 ms at 60 Hz 12 ms at 250 Hz |
| Maximum Cable Impedance | 25 ohms maximum per 1000 feet |
| Maximum Wire Size | Two 24 AWG wires per terminal |
| Calibration | Autocalibration at power-up and when a channel is enabled. |
| Isolation Between Channels | None |
| Isolation | 500V dc continuous between inputs and chassis ground, and between inputs and backplane. |
| Common mode voltage separation | ±1 volt |

^① Refer to the current recommendations of the RTD manufacturer to determine the best current source for your application.

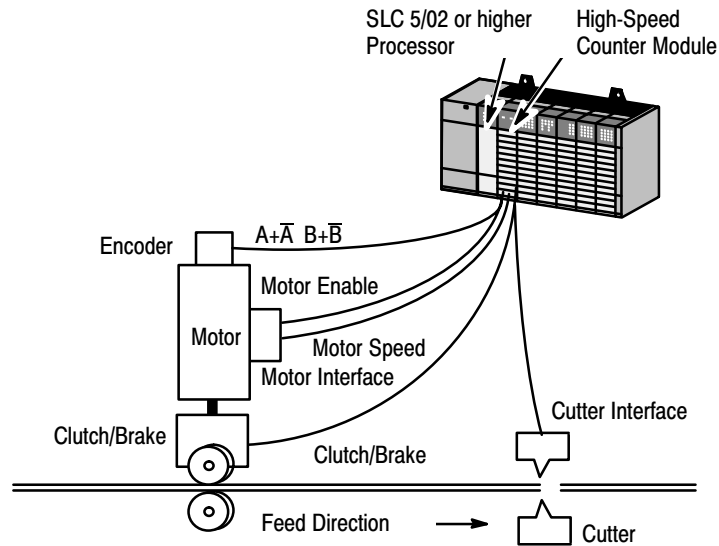

1746-HSCE High-Speed Counter Module

The High-Speed Counter Module provides bidirectional counting of high speed inputs from quadrature encoders and various high-speed switches. This single channel accepts input pulse frequencies of up to 50k Hz, allowing precise control of fast motions. This module is compatible with the SLC 5/02 and higher processors.

In addition to providing an Accumulated Count, the module provides the Rate Measurement indicating the pulse frequency in Hertz (Hz). The Rate Measurement is determined by accumulating input pulses over a fixed period of time. The dynamically configurable Rate Period ranges from 10 milliseconds to 2.55 seconds.

Features

Three modes of operation (Range, Rate, and Sequencer)
Four on-board open collector outputs

Benefits

Allows you to select the best mode to fit your application.
Allows control, independent of the SLC processor scan by the module.

Specifications

The specifications for the High-Speed Counter module are the same as shown in the *Specifications* on page 15 for the modular controller, with the following additions:

| Description | Specification |
|-------------------------|---------------|
| Backplane Current Draw | |
| 5V dc | 320 mA |
| 24V dc | 0.0 mA |
| Maximum Input Frequency | |
| Sequencer and Range | 50k Hz |
| Rate | 32.767k Hz |

1746-HSTP1 Stepper Controller Module

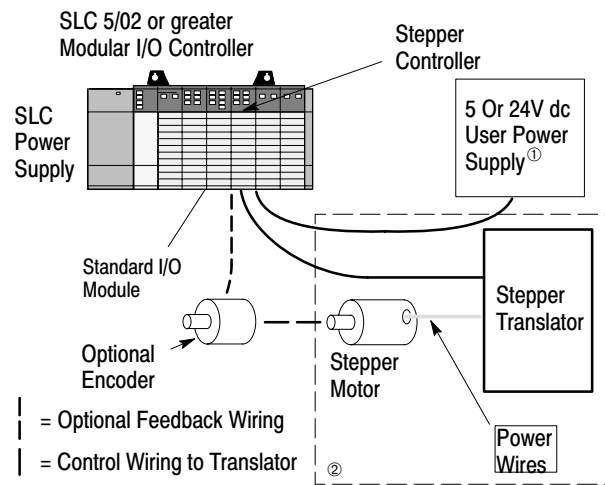

① The 24V may be obtained from the SLC Power Supply depending on application power requirements.

② Motor and translator furnished by the customer.

The Stepper Controller Module is a SLC family compatible module that provides single axis control for micro-stepping applications. This single slot module operates with a wide variety of SLC 500 processors and compatible encoders. The user can program the module for either incremental or absolute moves, depending on the application. The module is programmed with Advanced Programming Software.

Features

SLC 500 interface

Over $\pm 8,000,000$ counts of absolute positioning at pulse train velocities of up to 250K Hz.

Translator compatibility

Encoder compatibility

Programmable modes of operation (Configuration, Command, and Diagnostic)

Five LED status indicators

Built-in loop back diagnostics

Benefits

Works with SLC 500 processors.

Provides accurate positioning of a mechanism to a precise point.

User can configure module for translators requiring either a pulse train/direction input or a CW/CCW pulse train input to operate.

Accepts position feedback from a single encoder for closed loop operation.

Eliminates the need for DIP switches to set for operation and configuration.

Provides quick status information and troubleshooting help.

Permits monitoring of the pulse train commands issued to the stepper motor driver/translator.

The backplane current draw at 5V dc is 0.2 Amps and 0.09 Amps (max.) at 24V dc.

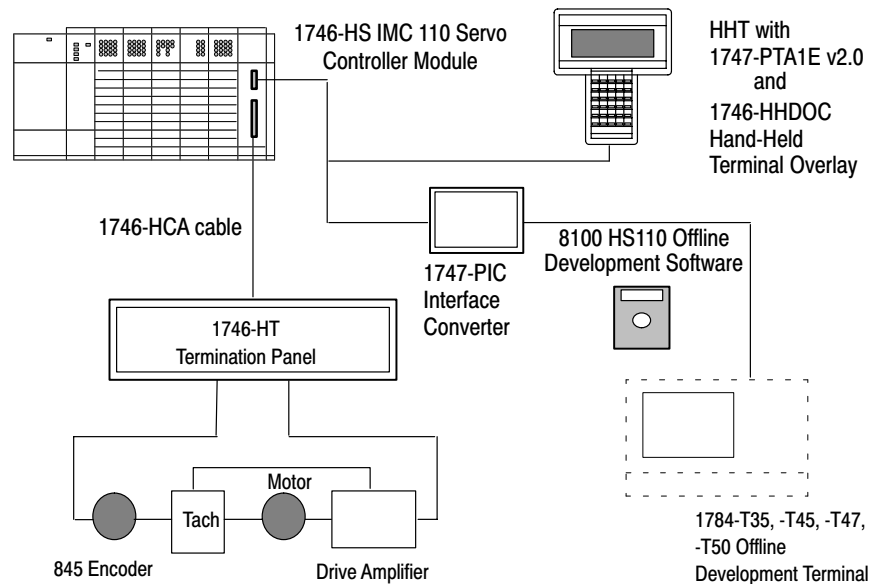

1746-HS IMC™ 110 Servo Positioning Module

The IMC 110 Motion Control System is a single-axis closed loop servo positioning module that plugs into a single slot of the SLC 500 programmable controller. When used with servo drives, motors and encoders, the IMC 110 becomes the key component of a low cost and powerful motion control system. Motion Management Language (MML) and Graphical Motion Control Language (GML) provide two easy-to-use offline programming tools, which aid you in debugging and graphics interface.

The IMC 110 replaces mechanical methods of controlling machine speed and position. The IMC 110 directs the movement of a single axis, or shaft, through a pre-programmed sequencer, while it monitors an encoder for position feedback.

Features

Four fast I/O points
 +10V dc signal
 5 ms Servo Loop Closure Rate
 SLC 500 Interface
 Termination Panel Interface

Benefits

Controlled by the IMC 110 system, saving valuable throughput time.
 Provides an interface to most servo drives.
 Provides a high degree of accuracy and system response.
 Supports either an SLC 500 fixed or modular system.
 Provides a wiring connection for fast I/O, E-stop, power supplies, drive command and encoder feedback.

The backplane current draw at 5V dc is 0.36 Amps and 0 Amps at 24V dc.

Remote I/O Modules

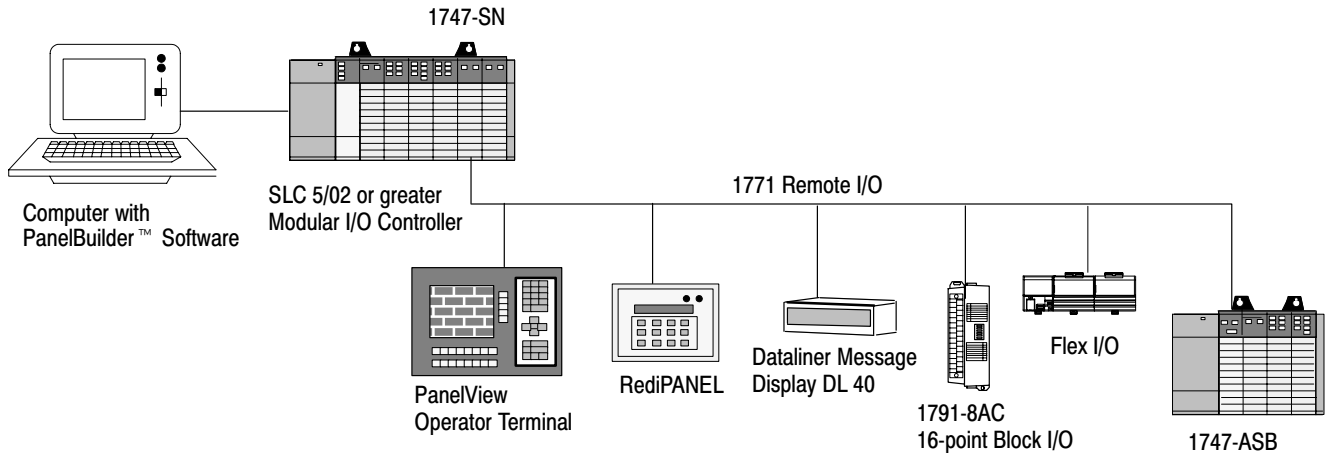

1747-SN Remote I/O Scanner

The Remote I/O Scanner provides high-speed remote communication between an SLC processor and Allen-Bradley operator interface and control devices. The scanner provides connectivity of your SLC 5/02 or higher processor to devices such as RediPANEL, DL40 Dataliner, PanelView, all versions of Block I/O, Allen-Bradley drives, and 1771 I/O devices. Refer to page 37 for a brief description of these products.

The Series A Remote I/O scanner does not support block transfer operations. The Series B scanner supports block transfer of up to 64 words of data. The Remote I/O Scanner features the following:

Features

- Selectable baud rates (57.6, 115.2, and 230.4K baud)
- RIO link cable length of 3050 m (10,000 ft) (max.)
- Supports connection of up to 16 physical devices
- Block transfers to RIO adapter devices
- Supports Remote I/O passthru (SLC 5/03 and SLC 5/04 processors)

Benefits

- Provides noise immunity over various cable distances.
- Allows for distribution of devices over a wide physical area.
- Provides a wide range of applications to be addressed.
- Sends large amounts of data to RIO devices without effecting total system throughput.
- Allows you to download and change applications in PanelView and dataliner devices.

1747-ASB Remote I/O Adapter Module

The Remote I/O Adapter module is a single-slot, RIO communication link module. It occupies the first slot (slot 0) of a 1746 remote chassis, where the SLC processor normally resides. The ASB module acts as a gateway between an SLC 500 scanner and the I/O modules in the 1747-ASB remote and expansion chassis.

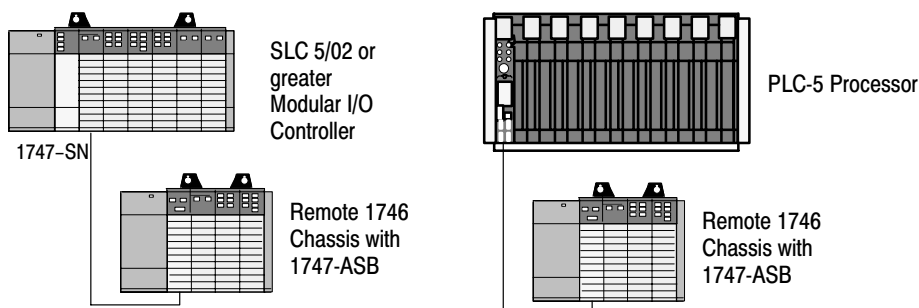

The ASB module is compatible with all Allen-Bradley RIO scanners. The Remote I/O Adapter module features the following:

Features

- Supports 1/2-slot, 1-slot, and 2-slot addressing modes
- Monitor three 7-segment displays
- Secure I/O and DIP switch configurations

Benefits

- Provides efficient image utilization by allowing you to assign the amount of image space required per slot.
- Provides status information and troubleshooting.
- Allows you to inhibit operation if the configuration or DIP switch settings were modified since the last save.

Specifications for 1747-SN and 1747-ASB

The specifications for the 1747-SN and 1747-ASB are the same as shown in the *Specifications* on page 15 for the modular controller, with the following additions and exception (for example, operating temperature for 1747-SN):

| Specification | SN | ASB |
|----------------------------------|------------------------------------|-----------------|
| Backplane Current Draw | 900 mA at 5V dc | 375 mA at 5V dc |
| Compatible Remote I/O Link Cable | Belden 9463 | |
| Extended Node Support | Yes | |
| Operating temperature (1747-SN) | 0° C to +55° C (+32° F to +131° F) | |

Remote I/O Specifications

| Baud Rate | Cable Distance |
|-------------|--------------------|
| 57.6K baud | 3050 m (10,000 ft) |
| 115.2K baud | 1524 m (5,000 ft) |
| 230.4K baud | 762 m (2,500 ft) |

1747-DCM Direct Communication Module

The Direct Communication Module (DCM) links the SLC 500 controller to the Allen-Bradley PLC for distributed processing. The DCM acts as a remote I/O adapter on a remote I/O link. Information is transferred between a local PLC or SLC scanner and a remote 1747-DCM module during each remote I/O scan. The number of DCMs that a scanner can supervise depends on the number of racks the scanner supports and the rack size of the DCM. Each SLC 500 fixed controller with a Catalog Number 1746-A2 expansion rack supports one DCM. The SLC 500 modular controllers can support multiple DCMs.

The DCM can be configured for one of the following:

- 1/4 rack = 2 words (1 remote I/O word and 1 status word)
- 1/2 rack = 4 words (3 remote I/O words and 1 status word)
- 3/4 rack = 6 words (5 remote I/O words and 1 status word)
- full rack = 8 words (7 remote I/O words and 1 status word)

Specifications

The specifications for the Direct Communication Module are the same as shown in the *Specifications* on page 15 for the modular controller, with the following additions:

| Description | Specification |
|------------------------|----------------------------------|
| Backplane Current Draw | |
| 5V dc | 0.36A |
| 24V dc | 0.00A |
| Baud Rate | Maximum Cable Distance |
| 57.6K Baud | 3048 m (10,000 ft) |
| 115.2K Baud | 1524 m (5,000 ft) |
| 230.4K Baud | 762 m (2,500 ft) |
| Operating Temperature | 0° C to 55° C (+32° F to 131° F) |

Remote I/O Devices

The following remote I/O devices interface with the SLC 500 remote I/O modules.

1791 Block I/O

Block I/O is a self-contained I/O interface that provides the functionality of the I/O rack, adapter, power supply, and I/O module in a single interface. The block communicates over the Allen-Bradley remote I/O network, joining other Allen-Bradley devices such as operator interface, drives, remote I/O chassis, and vision systems. For additional information refer to Publication 1791-1.3.

1794 Flex I/O

Flex I/O is a flexible, compact I/O system that saves engineering, installation and troubleshooting time. Flex I/O consists of interchangeable components that you select for your specific needs. The parts snap together easily, creating a compact I/O system for your SLC and PLC controllers. Extra hardware and wiring are eliminated by combining the I/O module and terminal block into a single unit. For additional information refer to Publication 1794-2.1.

2705 RediPANEL Operator Modules

RediPANEL Operator modules combine push buttons, wiring, I/O modules, a message display, and other control panel components in a single pre-packaged, ready-to-install unit. For additional information refer to Publication 2705-1.0.

2706 Dataliner Message Displays

The Dataliner Message Displays provide a cost-effective means of communicating essential machine or process status, alarm conditions, and operator prompts across a machine or a large plant floor. For additional information refer to Publication 2706-1.0.

Drives

Adjustable frequency AC drives and high performance DC drives provide exceptional reliability in critical motor control applications. They offer process control, energy savings, and communication to I/O devices such as PanelView terminals through the SLC 500 modular controller. For additional information refer to Publication DHQ-6.

Pyramid Solutions Program (PSP)

The Pyramid Solutions Program provides additional third-party products that interface to remote I/O. For additional information refer to Publication PSP-5.1.

DeviceNet Network

A device network connects plant floor devices directly to the control system (e.g., SLC 500 modular controller) reducing the number of I/O interfaces and wiring associated with a typical hard-wired solution. The DeviceNet communication network is a completely open device network and has the support of industry's leading sensor, actuator, and control manufacturers.

In a typical configuration, the 1747-SDN DeviceNet Scanner acts as an interface between DeviceNet devices and the SLC 5/02, SLC 5/03, and SLC 5/04 processors. The scanner communicates with DeviceNet devices over the network to:

- read inputs from a device
- write outputs to a device
- download configuration data
- monitor a device's operational status

The scanner communicates with the SLC 500 modular processors to exchange I/O data. Information exchanged includes:

- device I/O data
- status information
- configuration data

A single scanner (master) can communicate with up to 63 nodes (slaves) on DeviceNet. The SLC system supports multiple scanners if more devices are required to be controlled by a single SLC 500 processor.

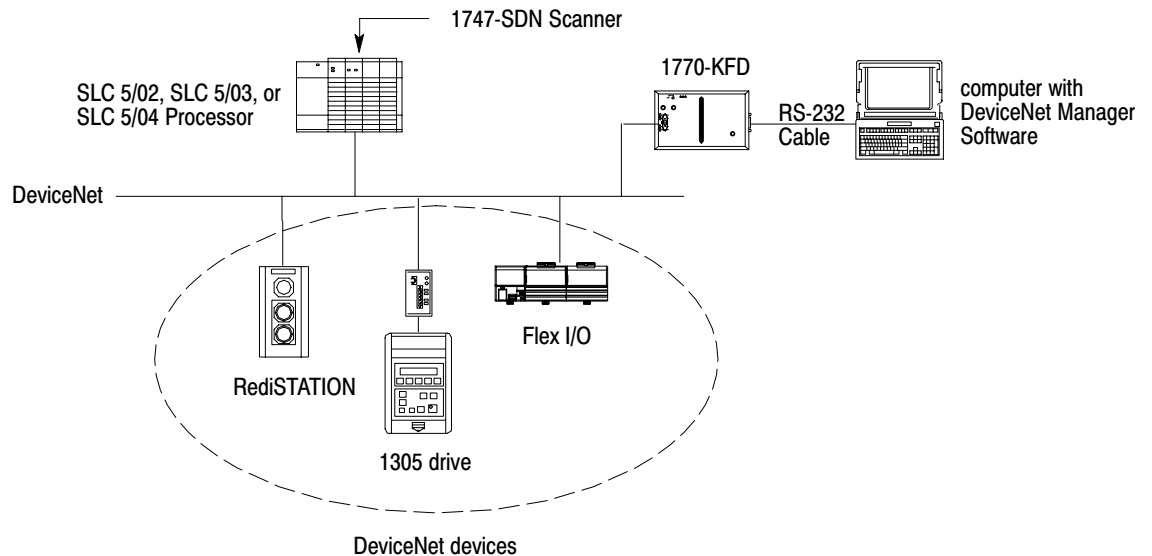

DeviceNet Network Length

The DeviceNet network lengths are listed below.

| Network Length | Baud Rate |
|--------------------|-----------|
| 100 m (328.08 ft) | 500K baud |
| 200 m (656.16 ft) | 250K baud |
| 500 m (1640.42 ft) | 125K baud |

Remote Communication

SLC 500 products communicate to serial devices using the following interface products.

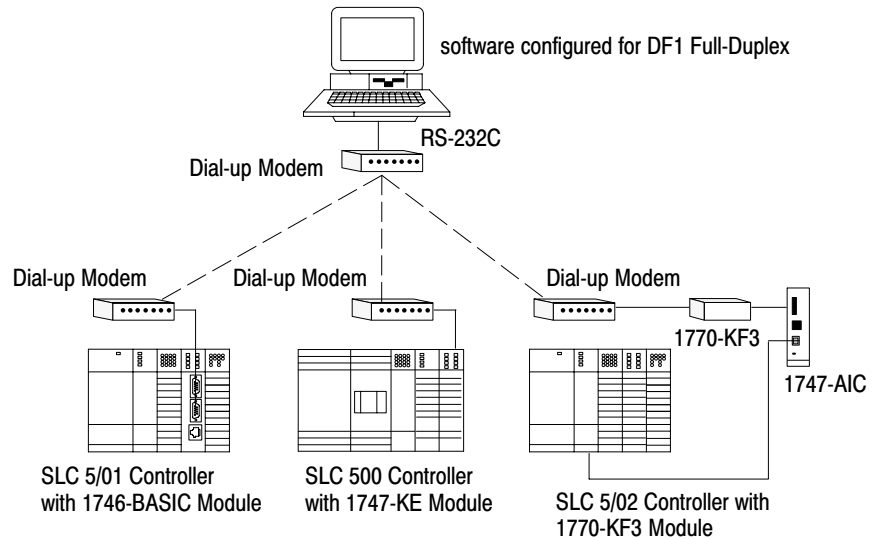

Only dial-up modems can be used in the above configuration.

1747-KE DH-485/RS-232C Interface Module

The DH-485/RS-232C Interface module provides a bridge between the DH-485 communication network and RS-232 using Allen-Bradley's DF1 communication protocol. When used in a SLC 500 chassis with a modem, you can:

- remotely program and troubleshoot any single SLC 500 processor
- remotely communicate to a DH-485 network of SLC 500 processors
- remotely collect data directly from the data table of any SLC 500 processor
- use the SLC 500 as a remote terminal unit

1746-BAS BASIC Module and BASIC Development Software

The SLC 500 BASIC module provides two configurable serial channels (RS-232/423, RS-422, and RS-485) and one DH-485 channel, up to 24K bytes of battery-backed RAM, plus an additional 32K bytes of EEPROM. Using either the 1747-PBASE development software or terminal emulation software, you can use the BASIC module to:

- interface to modems (DF1 full- or half-duplex) for transferring data from any SLC 500 processor to other DF1 devices at remote locations
- provide RTU functionality including dial-up and report by exception
- generate and print reports
- perform floating point math functions
- remotely communicate via other protocols using the ProSoft chips

1770-KF3 DH-485 Communication Interface Module

The DH-485 Communication Interface module is a standalone device that provides the same functionality as the 1747-KE interface module. However, when communicating from a remote location to a DH-485 network, the 1770-KF3 does not require a 1747-AIC module.

Remote Communication Functions

The above communication modules connect to most types of dial-up network or direct connect modems. The following modems can be used:

- Manual – typically acoustically coupled modems
- DTE Controlled Answer – attached to phone lines
- Auto Answer – automatically answers and hangs-up the phone
- Direct Connect – connected to a dedicated, leased phone line

The following table shows how serial devices interface with SLC 500 products.

| Feature | 1770-KF3 | 1747-KE | 1746-BAS |
|--|----------|---------|----------|
| Advanced Programming Software functions supported | • | • | NA |
| Module specific programming language | NA | NA | • |
| External power required | • | NA | NA |
| Standalone "desktop" | • | NA | NA |
| SLC 500 I/O module | NA | • | • |
| Terminal required for configuration | NA | NA | • |
| Descriptive configuration menus | NA | • | NA |
| Dial-up modem support | NA | • | • |
| Link coupler required for point-to-point communication | • | NA | NA |
| Link coupler required for network communication | NA | • | • |
| DH-485 support | • | • | • |
| DH-485 token passing master | • | • | • |
| DF1 Full-duplex support | • | • | • |
| DF1 Half-duplex slave - local mode | • | • | • |
| DF1 Half-duplex slave - remote mode | • | • | • |
| Responds to polls from DF1 half-duplex master | • | • | • |
| Report by exception capability | NA | • | • |
| ProSoft Protocol Chip support | NA | NA | • |

NA (Not Applicable)

Networking Options

SLC 500 programmable controllers communicate across an embedded DH-485 network for program support and monitoring. The following products provide networking options for the SLC 500 programmable controllers.

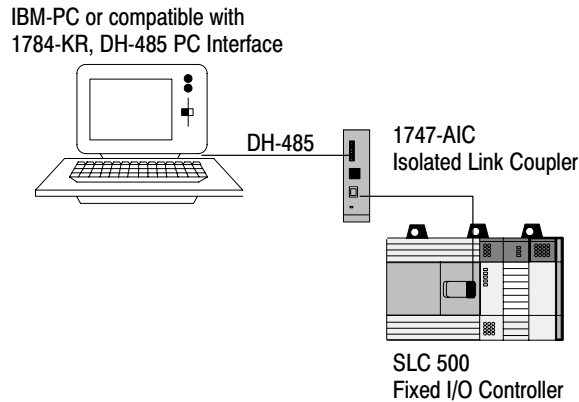

1784-KR Personal Computer Interface Card

The Personal Computer Interface Card provides an interface for IBM XT/AT and compatible computers to communicate over the Allen-Bradley DH-485 communication network. This includes communication to the Allen-Bradley line of SLC 500 programmable controllers.

Features

PC XT/AT Interface to
DH-485

DH-485 isolation

Reduced personal computer
overhead

Benefits

Eliminates the need for the personal
interface converter when using
Advanced Programming Software.

Eliminates the need for an isolated
link coupler.

Provides a faster update time for the
user interface through the
co-processor.

Specifications

The specifications for the Personal Computer Interface Card are the same as shown in the *Specifications* on page 15 for the modular controller, with the following additions:

| Description | Specification |
|---------------------|-----------------------------------|
| Power Requirements | 5V dc, 1.8A |
| Outputs | RS-485 electrical/DH-485 protocol |
| Hardware Interrupt | IRQ2, IRQ3, IRQ4, IRQ5 |
| Cable Length (max.) | 1219 m (4000 ft) |

6001-F2E Standard Driver

The Standard Driver allows the 1784-KR card to be used on the DH-485 communication network for data acquisition applications. This allows you to write 'C' application programs that communicate directly over the DH-485 network to stations such as the SLC 500. Non-token passing slave stations such as the 2755-DM6 Bar Code Reader are also supported.

Features

Provides a Set of Linkable 'C' Function Calls

Supports Microsoft 'C' v5.1 and Borland Turbo 'C' v2.0 Compilers

Provides application libraries

Benefits

Establishes communications with devices on the DH-485 network.

Eliminates the learning curve of new software packages.

Aids in data table read or write diagnostic commands.

1747-AIC Isolated Link Coupler for DH-485 Connection

The Isolated Link Coupler provides an electrically isolated network connection for an SLC 500 controller. One coupler is required at each DH-485 network drop. The coupler includes a 304.8 mm (12 in.) cable for connection to the programmable controller. Note that a maximum of 32 devices can be connected to the network.

Programming Options

The following section describes three types of programming options available for the SLC 500. The first is the 1747-PA2E Advanced Programming Software (APS), the second is the 1747-PT1 Hand-Held Terminal (HHT) that also requires the 1747-PTA1E memory pak, and the third is the SLC 500 A.I. Series programming software.

1747-PA2E Advanced Programming Software

The Advanced Programming Software (APS) v6.0 or later, enables you to program the SLC 500 family processors and the MicroLogix 1000 Programmable Controllers using the Allen-Bradley T47 or T70 terminal, 386/SX, NEC VERSA™ E Series Notebook, or GATEWAY 2000™ models 386DX/25, 386DX/33, 486DX/33, 486DX2/50, and 486DX2/66, or compatible personal computer.

Features

Full-line processor support

DH-485 and DF1 support

Data Highway Plus support (DH+)

Runtime online editing

Benefits

Programs any SLC 500 Fixed processor; SLC 5/01, SLC 5/02, SLC 5/03, and SLC 5/04 modular processors; and MicroLogix 1000.

Provides a variety of communication options to meet your application requirements.

Supports direct connection between the SLC 5/04 modular processor and DH+.

Allows entry of programs and data while online in the Run mode when using a SLC 5/03 or SLC 5/04 processor.

Features

Command line entry of instructions and parameters

Online context sensitive help

System auto configuration

Cut, copy, paste editor

Search and replace

APS Import/Export Utility (APSIE)

Benefits

Provides time saving keystrokes.

Provides quick access to instruction and status file information.

Automatically reads system configuration information (including I/O and chassis data), saving you valuable startup time.

Permits ladder logic to be re-used.

Allows quick modification of ladder logic to match unforeseen hardware changes.

Allows you to convert APS archive files and program documentation into ASCII text files and vice versa.

System Specifications

| Description | Specification |
|-------------------|---|
| Computer | Allen-Bradley T47 or T70 terminal, 386/SX, NEC VERSA™ E Series Notebook, or GATEWAY 2000E models 386DX/25, 386DX/33, 486DX/33, 486DX2/50, 486DX2/66, or compatible PC |
| Hardware | 640 Kbytes of RAM (a minimum of 2 Mbytes of extended memory is required) |
| Operating System | DOS version 3.3 or higher |
| Printer Interface | parallel or serial 80, 132, or 255 columns |

Refer to page [57](#) for the instruction set.

1747-PIC Interface Converter

The 1747-PIC Interface Converter changes RS-232 signal levels from your personal computer to RS-485 signal levels for the SLC 500 controller. The DH-485 protocol driver is provided by either the 1747-PA2E or 1747-PBASE software.

The converter includes an 279.4 mm (11 in) 25 pin ribbon cable for connection to the computer and a cable (Catalog Number 1746-C10) for connection to the SLC 500 controller.

1747-PT1 Hand-Held Terminal and 1747-PTA1E Programming Memory Pak

The Hand-Held Terminal (HHT) v2.03 is a powerful portable programming platform used to configure the SLC 500 Fixed, SLC 5/01, and the SLC 5/02 processors, enter or modify an application program, monitor the execution of the application program in real-time, or troubleshoot an application program. The HHT accepts programs with a maximum data table size of 6K. Each rung may contain up to 127 instructions. This differs from APS which has a maximum data table size of 16K and each rung can contain 128 instructions.

The programming memory pak is interchangeable and available in four languages. When used with the memory pak (v2.03), the HHT can be used to program the SLC 5/02 processor as well as connect to the DH-485 network. Note that the HHT does not support nested branching or conditional output branches.

Features

Rugged construction

Menu-driven firmware

LCD display

Network diagnostics

ZOOM function

Formatted display

Benefits

Designed for a variety of industrial environments.

Displays step-by-step directions.

Shows up to five rungs of ladder logic at one time.

Checks the operation of the DH-485 network (v2.03).

Displays detailed instruction information.

Displays PID and MSG instructions (v2.03).

Specifications

| Description | Specification |
|--------------------------|---|
| Display | 8 line x 40 character super-twist nematic LCD |
| Keyboard | 30 keys |
| Operating Power | 0.105A (max.) at 24 VDC |
| Communication | DH485 |
| Environmental conditions | |
| Operating temperature | 0 to +40° C (+32° to +104° F) |
| Storage temperature | -20° to +65° C (-4° to +149° F) |
| Humidity rating | 5 to 95% (non-condensing) |
| Certification | UL listed, CSA approved |

Refer to page [57](#) for the instruction set.

SLC 500 A.I. Series Programming Software

SLC 500 A.I. Series programming software is a DOS based, user-friendly, menu driven and function-key driven software package for programming the SLC 500 family processors using familiar ladder logic. The software package provides online and offline development, documentation and reporting capabilities.

The A.I. Series appeals to people who:

- develop complete ladder programs
- occasionally add or modify ladder rungs and data table values
- troubleshoot ladder programs

Software features enable the beginner to quickly become proficient in ladder logic development and documentation. The advanced user will find the software's powerful editing and diagnostic tools to be great time savers during ladder programming development and troubleshooting.

| Features | Benefits |
|-------------------------------------|---|
| Online programming | Provides online and offline support for the SLC 5/03 and SLC 5/04 processors. |
| Symbolic programming | Allows you to use symbol names instead of addresses for programming |
| Automatic addressing | Helps manage data table and I/O usage information for you. |
| Cross Reference Information Display | Displays a listing of all instruction types, rung numbers, and program files for the highlighted address. |
| Custom display screens | Allows selection and display of 40 different addresses on a single screen |
| Advanced diagnostics | Allows user to select a section of ladder logic to displays rung numbers, output status and descriptions for troubleshooting. |
| Program compare | Detects differences between two projects. |



Operator Interface

Allen-Bradley recognizes the need for efficient interface products. The Data Table Access Module aids in accessing information and monitoring an SLC 500 control system at the plant floor level.

1747-DTAM-E Data Table Access Module

The Data Table Access Module (DTAM) is a plant floor device that allows you to access data file information, change operating modes, monitor and clear processor faults, and transfer memory from or to a EEPROM on any SLC 500, SLC 5/01, SLC 5/02, SLC 5/03, or SLC 5/04 processor. Multiple DTAMs can be connected to a single processor. Interactive messaging is also supported between the DTAM and the SLC 5/02, SLC 5/03, or SLC 5/04 processor. The DTAM provides the following features:

| Features | Benefits |
|---------------------------|--|
| DH-485 network compatible | Communicates with up to 31 controllers, one at a time, up to 1219 m (4000 ft). |
| Data monitor or modify | Permits data values to be changed in the RUN or PROGRAM mode. |
| Quick recall macros | Stores frequently used address locations, saving time and simplifying application set-up and modification. |
| Auto-Attach mode | Automatically initiates communication with the last attached processor after a power cycle, saving costly down time and reducing keystrokes. |

| Features | Benefits |
|-------------------------------|--|
| On-Board module configuration | Provides non-volatile EEPROM memory for easy onsite module set up. |
| Multilingual display | Selectable operator prompting in any of six languages. |
| Backlit LCD display | Allows for easy viewing in all lighting conditions. |
| Responds to MSG instructions | Allows interaction between the operator and the ladder program. The SLC 5/02, SLC 5/03, or SLC 5/04 processor ladder program directs the dialog. |

Specifications

| Description | Specification |
|--------------------------|--|
| Display | 2 line x 16 character super-twist nematic LCD with LED backlighting |
| Keyboard | 19 keys with tactile feedback |
| Operating Power | 0.104 A (max.) at 24V dc |
| Communications | DH-485 |
| Environmental conditions | |
| Operating temperature | 0° C to +55° C (+32° F to +131° F) |
| Storage temperature | -20° C to +65° C (-4° F to +149° F) |
| Humidity rating | 5 to 95% (non-condensing) |
| Certification | UL listed, CSA approved. Meets NEMA Type 12 and 13 enclosure applications. |

Bulletin 2707 DTAM Plus Operator Interface

The DTAM Plus provides a highly functional operator interface to the SLC 500 family of processors. This device features a 4 line x 20 character display window for viewing SLC 500 data table information, operator prompts, and alarm data. The DTAM Plus uses the Allen-Bradley DH-485 network or a point-to-point link using RS-232 or DH-485. Refer to Publication 2707-2.0 for additional information.

Bulletin 2707 DTAM Micro

The DTAM Micro extends the DTAM Plus product line by providing another operator interface to the SLC 500 family of processors. DTAM Micro is a low cost operator interface and is physically smaller than the DTAM Plus. This device features a 2 line x 20 character display window for viewing data table information and operator prompts. Up to fifty application screens can be stored in memory.

DTAM Micro is available with either an RS-485 port or an RS-232 port. The RS-232 port is used to communicate point-to-point with the SLC 5/03. Use the RS-485 port to communicate point-to-point with the SLC processor or over the DH-485 network via Catalog 1747-AIC Isolated Link Couplers. The point-to-point connection allows for faster communication throughput and less DH-485 network loading.

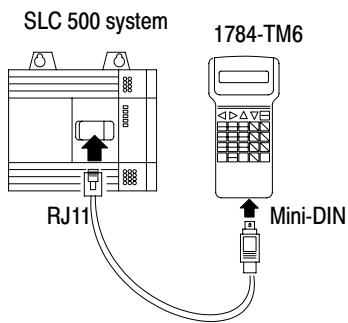

1784-TM6 I/O Monitor

The I/O Monitor is a hand-held device that allows you to view and modify data table information in an SLC 500 or PLC-5 programmable controller. You can display one file element, two words, or up to sixteen non-contiguous or contiguous bits. The I/O monitor allows you to search ladder programs for output addresses, change the processor mode, display fault information, and clear minor and major faults. Refer to Publication 1784-6.5.17 for additional information.

2711 PanelView Operator Terminals

The PanelView 550, 900, 1200, and 1400 Operator Terminals replace hard-wired control panels with CRT screens that are simple to configure. PanelView terminals provide you with extensive diagnostic information during fault conditions via message windows, alarm windows, and simple graphics. All four PanelView Operator Terminals easily connect to SLC 500 or PLC-5 systems allowing communication on the Remote I/O network.

The PanelView 550 Operator Terminal provides a high performance operator interface in a small, flat panel design. The flat panel LCD display has 256 x 128 pixel resolution. Field replaceable backlight extends the life of the terminal and maximizes system up time.

The PanelView 900 Operator Terminal provides a high performance operator interface in a small, flat panel design. The flat panel, AC gas plasma monochrome display has 640 x 400 pixel resolution that provides optimum viewability. The PanelView 900 Operator Terminal allows you to enter input using function keys or a touch screen.

With the DH-485 version, you can connect the PanelView 550 or PanelView 900 to a single SLC 500 processor or multiple SLC 500 processors on the DH-485 network. The PanelView 550 and PanelView 900 Operator Terminals support DH-485 point-to-point or network transfers.

With the RS-232 version, you connect directly to channel 0 of an SLC 5/03 or SLC 5/04 processor using DH485 protocol. This gives you dedicated DH485 connection for high priority data. The RS-232 channel supports passthru from the DH+ network to the PanelView 550 or PanelView 900 through channel 0 of an SLC 5/04 processor.

For additional information refer to Publication 2711-1.1.

Allen-Bradley Support

In today's competitive environment, when you buy any product, you expect that product to meet your needs. You also expect the manufacturer of that product to back it up with the kind of customer service and product support that will prove you made a wise purchase.

As the people who design, engineer, and manufacture your Industrial Automation Control equipment, Allen-Bradley has a vested interest in your complete satisfaction with our products and services.

Allen-Bradley offers support services worldwide, with over 75 Sales/Support Offices, 512 authorized Distributors and 260 authorized Systems Integrators located throughout the United States alone, plus Allen-Bradley representatives in every major country in the world.

Contact your local Allen-Bradley representative for:

- sales and order support
- product technical training
- warranty support
- support service agreements

User Documentation on CD-ROM

Improve productivity with quicker and easier access to product information. Volumes of Allen-Bradley product documentation are on the DataDisc™ CD-ROM Information Library (cat. nos. 1795-CDRS and 1795-CDRL). Use the search facility to locate all documentation instances of any item you specify. You can view and print the relevant pages.

Configuring an SLC 500 System

The following section describes:

- How to configure an SLC 500 chassis style system
- How to determine 1746 I/O module compatibility
- Available instructions used with the 1747-PA2E Advanced Programming Software and the 1746-PT1 Hand-Held Terminal
- Fixed controller wiring diagrams
- Dimensions for SLC 500 fixed and modular controllers, and compatible products

SLC 500 Chassis Configuration Instructions

This worksheet is intended to help you configure a modular style system. If a fixed I/O controller is more appropriate for your application, refer to page 8 of this System Overview. Each worksheet is designed to help you configure one chassis of I/O. If multiple chassis are necessary for your application, additional chassis should be configured using another worksheet.

1. Estimate the total amount of memory this system requires
 - a. Add up the number of discrete I/O points and place it in (a).
 - b. Add up the number of analog I/O points and place it in (b).
 - c. Add up the number of specialty I/O modules and place it in (c).
 - d. Multiply a, b, and c by the number indicated.
 - e. Total those numbers to give you a memory estimate.

2. Select a processor

| Required Memory | Required I/O | Catalog Number |
|-----------------|------------------|----------------|
| 0 to 1K | Less than 256 | 1747-L511 |
| 1K to 4K | Less than 256 | 1747-L514 |
| 1K to 4K | Greater than 256 | 1747-L524 |
| 4K to 12K | Greater than 960 | 1747-L532 |
| 4K to 12K | Greater than 960 | 1747-L541 |
| 12K to 28K | Greater than 960 | 1747-L542 |
| 28K to 60K | Greater than 960 | 1747-L543 |

Place your choice into slot 0 of chassis 1 on the worksheet.

3. Select the I/O
 - a. If multiple chassis system, make copies for each chassis.
 - b. Write in the chassis number.
 - c. Write in the appropriate slot numbers.
 - d. Refer to pages 17 through 21 for discrete I/O selection.
 - e. Refer to pages 22 through 33 for specialty and analog I/O selection.
 - f. Using the worksheet, list each I/O module in the slot you desire.
 - g. List the power consumption of each module in the designated columns. Be sure to account for future expansion.
 - h. When the chassis is complete, add up each power consumption column.
4. Select the correct power supply
 - a. Compare the Power Consumption totals with each power supply.
 - b. Choose the smallest power supply that provides sufficient power. Note that the current shown is rated at 55° C (131° F).
5. Select the chassis
 - a. Add up the number of slots used.
 - b. Select the smallest chassis which can hold your I/O. Be sure to account for future expansion.
6. Select the miscellaneous devices
To complete your system, include devices such as:
 - Cables
 - Communication Interfaces
 - Operator Interface Devices
 - Memory Modules

Fixed I/O Chassis Module Compatibility

You can use either of two methods to determine whether the 2-slot, fixed I/O expansion chassis will support a specific combination of modules.

- tabular method
- charting method

The table on the following page represents combinations of modules and indicates whether or not each combination is valid. The chart on page 56 represents the region of operating current that the fixed I/O expansion chassis supports.

Important: When referencing either method on the following pages, be aware that there are certain conditions that affect the compatibility characteristics of the BASIC module (**BAS**) and the DH-485/RS-232C module (**KE**).

When you use the BAS module or the KE module to supply power to a 1747-AIC Link Coupler, the Link Coupler draws its power through the module. The higher current drawn by the AIC at 24V dc is calculated and recorded in the tables for the modules identified as **BASn** (BAS networked) or **KE_n** (KE networked). Make sure to refer to these modules if your application uses the BAS or KE module in this way.

Tabular Method

Using the table on the next page, locate both of the modules you plan to use in the fixed I/O expansion chassis. Follow the top row across until you find one of the modules. Then follow the right column down until you find the other module. The symbol shown in the table cell that marks their intersection gives you information you must know before installing the modules.

- A dot indicates a valid combination.
- No symbol indicates an invalid combination.
- ▽ A triangle indicates an external 24V dc power supply may be required. (Refer to the Analog I/O Module User Manual, 1746-6.4.)

Charting Method

The following chart depicts the range of current combinations supported by the fixed I/O expansion chassis. To use it, you must first determine the backplane current draw and operating voltage for both of the modules you plan to use in the chassis. You can get these specifications from the table alongside the chart. Next, plot each of the currents on the chart below. If the point of intersection falls within the operating region, your combination is valid. If not, your combination cannot be used in a 2-slot, fixed I/O chassis.

| | 5VDC AMPS | 24VDC AMPS |
|-------------|--------------|---------------|
| IA4 | 0.035 | - |
| IA8 | 0.050 | - |
| IA16 | 0.085 | - |
| IM4 | 0.035 | - |
| IM8 | 0.050 | - |
| IM16 | 0.085 | - |
| OA8 | 0.185 | - |
| OA16 | 0.370 | - |
| OAP12 | 0.370 | - |
| IB8 | 0.050 | - |
| IB16 | 0.085 | - |
| IV8 | 0.050 | - |
| IV16 | 0.085 | - |
| IG16 | 0.140 | - |
| OV8 | 0.135 | - |
| OV16 | 0.270 | - |
| OB8 | 0.135 | - |
| OBP8 | 0.135 | - |
| OG16 | 0.180 | - |
| OW4 | 0.045 | 0.045 |
| OW8 | 0.085 | 0.090 |
| OW16 | 0.170 | 0.180 |
| IO4 | 0.030 | 0.025 |
| IO8 | 0.060 | 0.045 |
| IO12 | 0.090 | 0.070 |
| NI4 | 0.025 | 0.085 |
| NIO4I | 0.055 | 0.145 |
| NIO4V | 0.055 | 0.115 |
| FIO4I | 0.055 | 0.150 |
| FIO4V | 0.055 | 0.120 |
| DCM | 0.360 | - |
| HS | 0.300 | - |
| OB16 | 0.280 | - |
| IN16 | 0.085 | - |
| BASn | 0.150 | 0.125 |
| BAS | 0.150 | 0.040 |
| OB32 | 0.452 | - |
| OV32 | 0.452 | - |
| IV32 | 0.106 | - |
| IB32 | 0.106 | - |
| OX8 | 0.085 | 0.090 |
| NO4I | 0.055 | 0.195 |
| NO4V | 0.055 | 0.145 |
| ITB16 | 0.085 | - |
| ITV16 | 0.085 | - |
| IC16 | 0.085 | - |
| KE | 0.150 | 0.040 |
| KE n | 0.150 | 0.145 |
| OBP16 | 0.250 | - |
| OVP16 | 0.250 | - |
| NT4 | 0.060 | 0.040 |
| NR4 | 0.050 | 0.050 |
| HSTP1 | 0.200 | - |

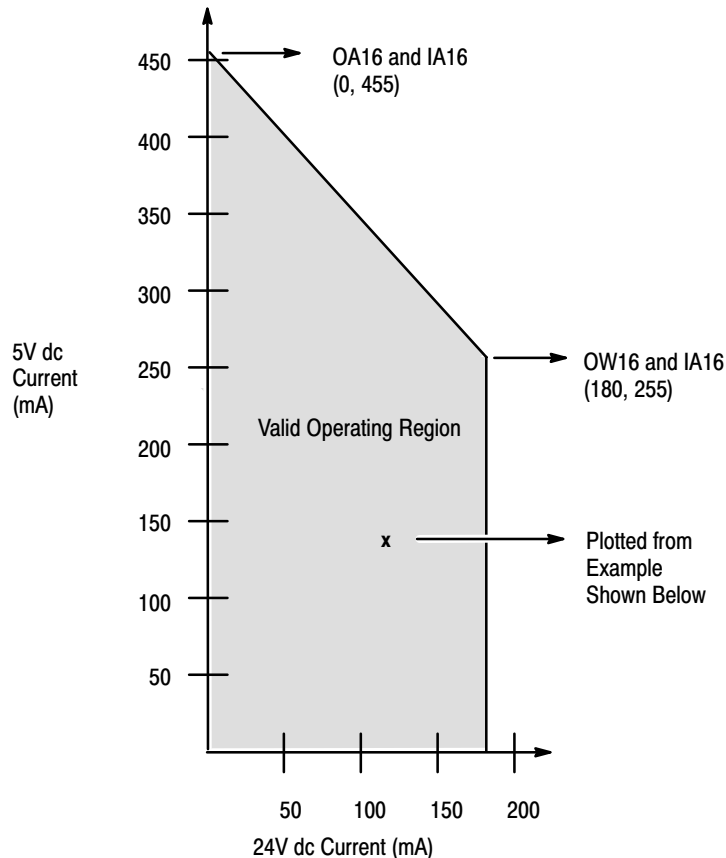

Example: Plot IN16 and NIO4V

IN16 = 0.085A at 5V dc

NIO4V = 0.055A at 5V dc and 0.115A at 24V dc

1. Add current draws of both modules at 5V dc to get 0.14A (140 mA).
2. Plot this point on the chart above (140 mA at 5V dc).
3. Plot current draw at 24V dc (115 mA at 24V dc).
4. Note the point of intersection on the chart above (marked x). This combination falls within the valid operating region for your fixed I/O chassis.

Important: The NO4I and NO4V analog output modules may require an external power supply. Refer to the analog user manual.

Instruction Set

Basic Instructions

Examine If Closed
 Examine If Open
 One Shot Rising
 Output Energize
 Output Latch
 Output Unlatch
 Timer On/Timer Off-Delay
 Retentive On-Delay Timer
 Count Up/Count Down
 High-Speed Counter
 Reset

I/O and Interrupt Instructions

I/O Interrupt Enable/Disable^①
 Reset Pending I/O Interrupt^①
 I/O Refresh^①
 Selectable Timed Enable/Disable^①
 Selectable Timed Start^①
 Interrupt Subroutine^①

Comparison Instructions^③

Equal
 Not Equal
 Less Than
 Greater Than
 Less Than or Equal
 Greater Than or Equal
 Masked Comparison for Equal
 Limit Test^①

Data Handling^③

Move
 Masked Move
 And
 Or
 Exclusive Or
 Not
 Convert to/from BCD
 Decode
 Load/Unload, First In First Out^①

Use the following instructions with your software or the HHT.

Load/Unload Last In First Out^①

Copy File

Fill File

Degrees to Radians^{②④}

Radians to Degrees^{②④}

Communication Instructions

Service Communications^①
 Message^①

Math Instructions^③

Add/Subtract

Multiply/Divide

Double Divide

Clear

Negate

Square Root^①

Scale^①

Scale with Parameters^{②④}

Absolute^{②④}

Compute^{②④}

Swap^{②④}

Arc Sine^{②④}

Arc Cosine^{②④}

Arc Tangent^{②④}

Cosine^{②④}

Natural Log^{②④}

Log to Base 10^{②④}

Sine^{②④}

Tangent^{②④}

X to the Power of Y^{②④}

Program Flow Instructions

Label

Jump

Jump to Subroutine

Return from Subroutine

Master Control Reset

Temporary End

Suspend

Subroutine

ASCII Instructions^{③④}

Test Buffer for Line

Number of Characters in Buffer

ASCII String to Integer

ASCII Clear Receive and/or Transmit Buffer

ASCII String Concatenate

ASCII String Extract

ASCII Handshake Lines

ASCII Integer to String

ASCII Read Characters

ASCII Read Line

ASCII String Search

ASCII String Compare

ASCII Write with Append

ASCII Write

Application Specific

Sequencer Output

Sequencer Compare

Sequencer Load^①

Bit Shift Right/Left

Special Instruction

Proportional, Integral, Derivative^①

^① Does not apply to the SLC 5/01 processor (Catalog Number 1747-L511 or 1747-L514) or the SLC 500 Fixed processor.

^② Applies only to SLC 5/03 (Catalog Number 1747-L532 OS302 or higher) and SLC 5/04 (Catalog Numbers 1747-L542, 1747-L542, and 1747-543 OS401 or higher) Processors.

^③ Only the SLC 5/03 (Catalog Number 1747-L532 or higher) and SLC 5/04 (Catalog Numbers 1747-L541, 1747-L542, and 1747-L543) processors support floating point math for these instructions.

^④ Does not apply to the HHT (catalog number 1747-PT1).

Fixed Wiring Diagrams

For detailed wiring diagram information for the fixed controller, refer to the *Installation & Operation Manual for Fixed Hardware Style Programmable Controllers*, Catalog Number 1747-NI001.

CATALOG NUMBER 1747-L20A
(12) 120V ac Inputs & (8) Relay Outputs

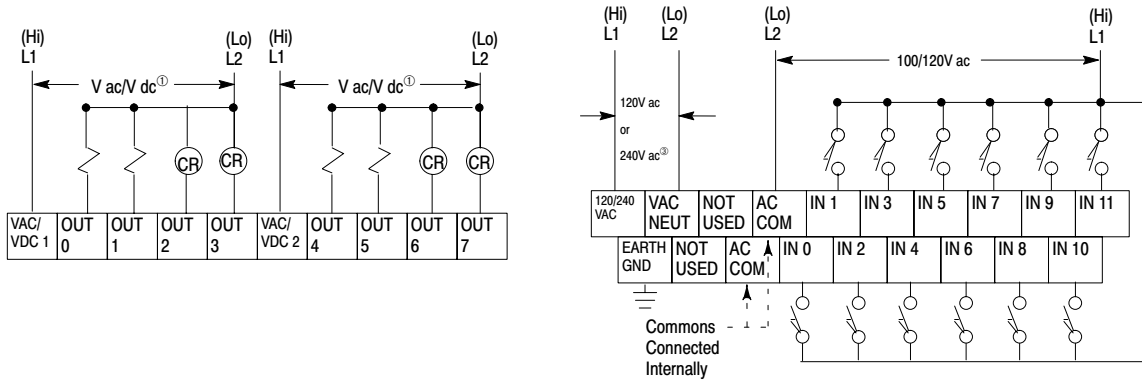

CATALOG NUMBER 1747-L20B
(12) 120V ac Inputs & (8) Triac Outputs

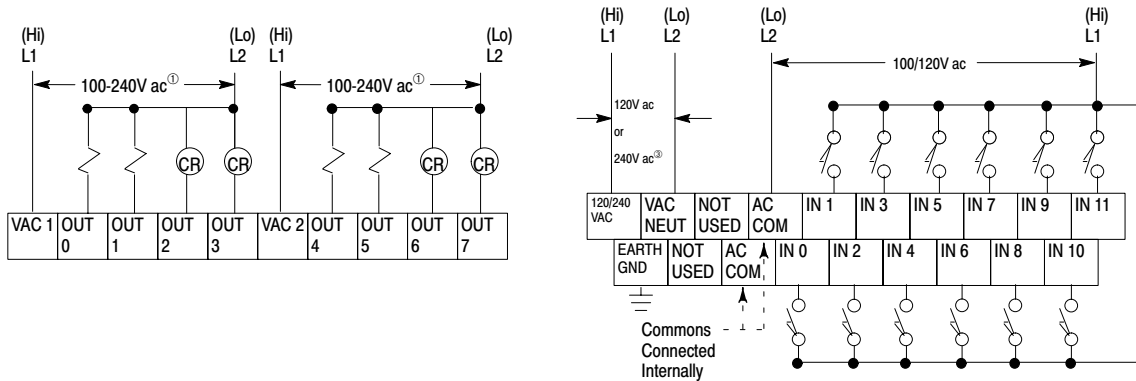

CATALOG NUMBER 1747-L20C
(12) 24 DC Volt Sinking Input Circuitry, High-Speed Counter Input & (8) Relay Outputs

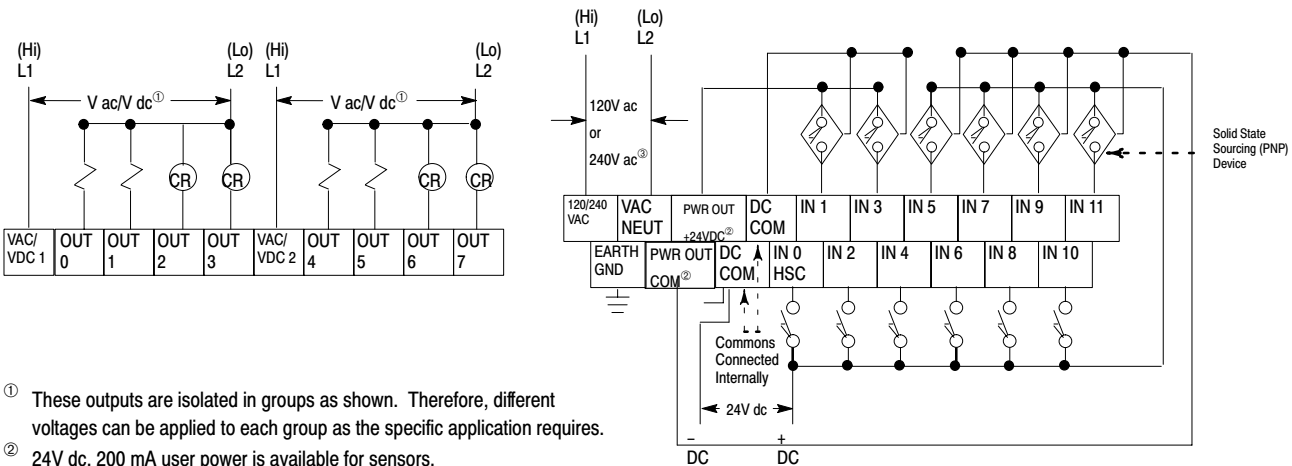

- ① These outputs are isolated in groups as shown. Therefore, different voltages can be applied to each group as the specific application requires.
- ② 24V dc, 200 mA user power is available for sensors.
- ③ 120 or 240 volt operation is automatically selected by the SLC processor.

CATALOG NUMBER 1747-L30A
 (18) 120 Volt AC Inputs & (12) Relay Outputs

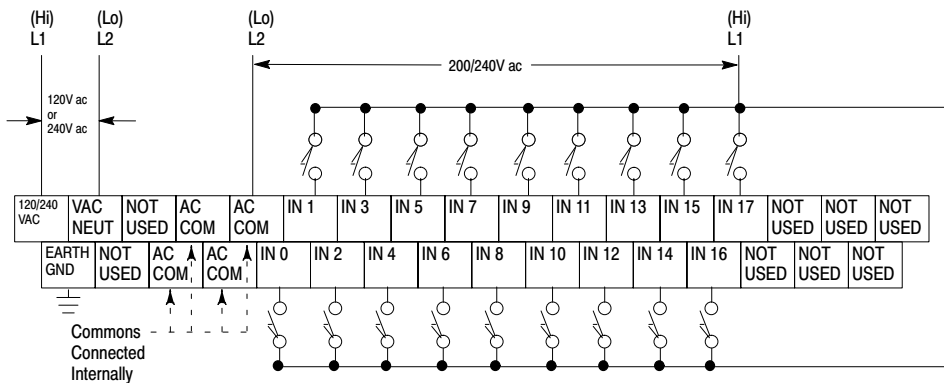
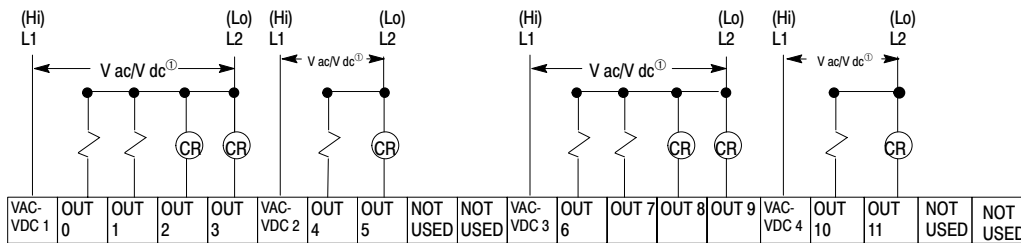

CATALOG NUMBER 1747-L40A
 (24) 120 Volt AC Inputs & (16) Relay Outputs

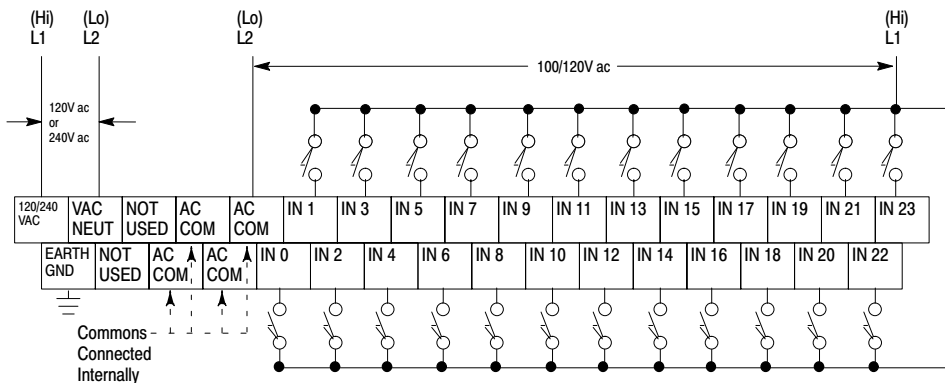
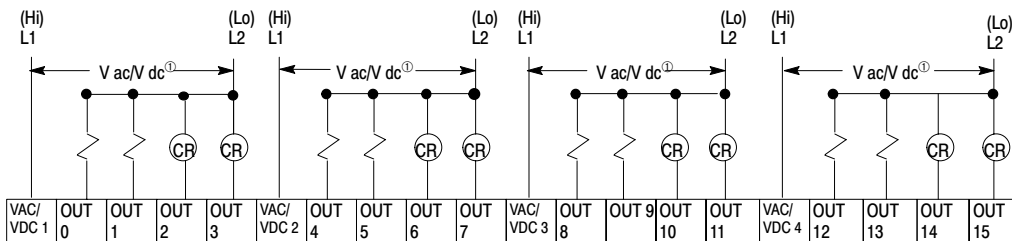

① These outputs are isolated in groups as shown. Therefore, different voltages can be applied to each group as the specific application requires.

Approximate Chassis Dimensions

millimeters (inches)

SLC 500 Fixed Controller

20 I/O Fixed Controller

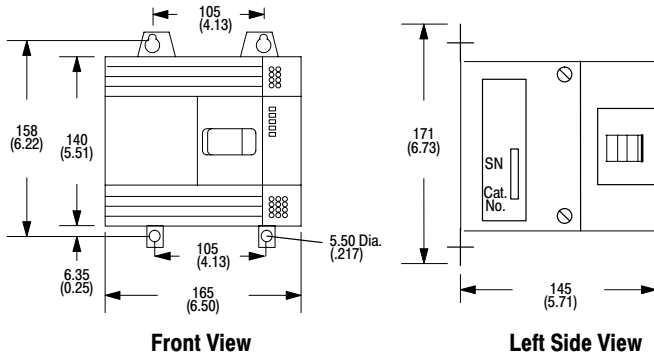

30 & 40 Fixed Controller

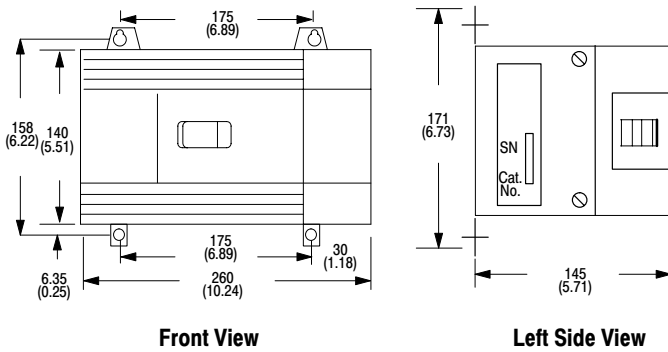

2-Slot Expansion Chassis

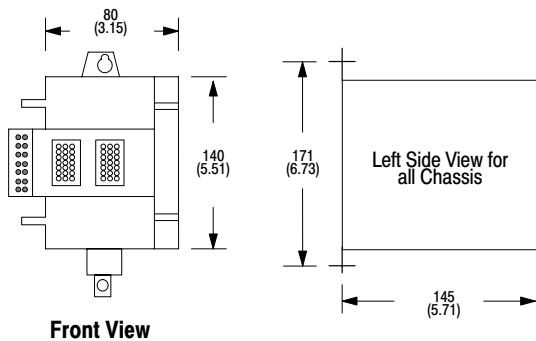

MicroLogix 1000 Controller

-L16BWA, -L16BBB, -L16BWB

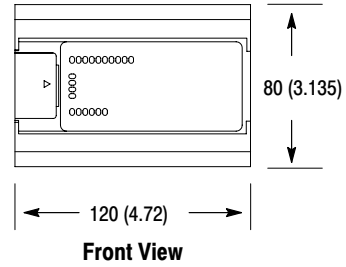

-L16AWA

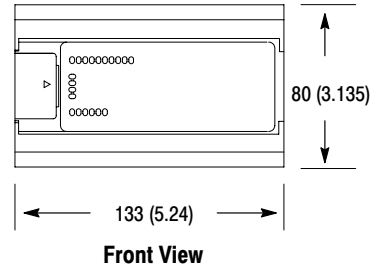

-L32AWA, -L32BWA, -L32AAA, -L32BBB, -L32BWB

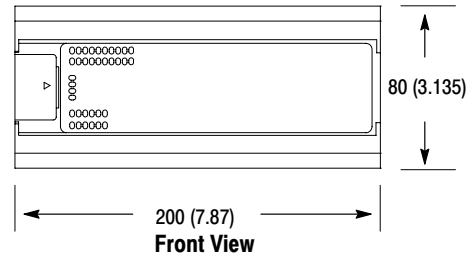

-L16AWA, -L16BWA, -L32AWA, -L32BWA, -L32AAA

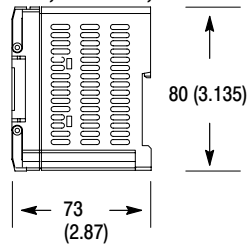

-L16BBB, -L16BWB, -L32BBB, -L32BWB

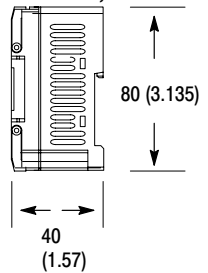

SLC 500 Modular Controller

4-Slot Chassis

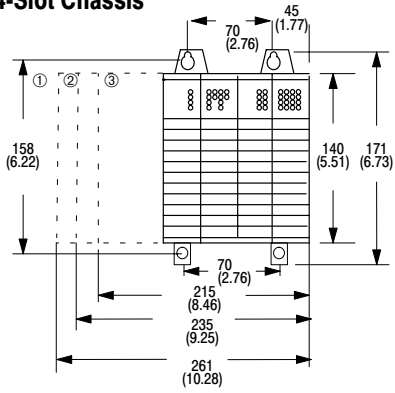

7-Slot Chassis

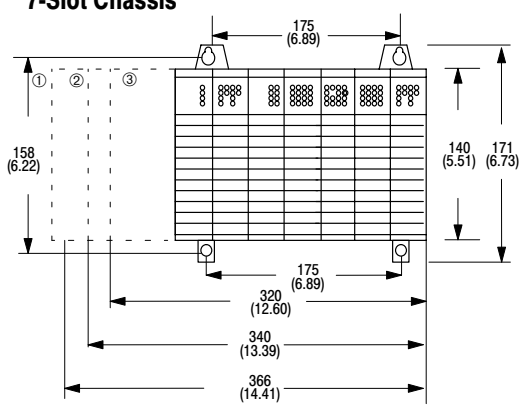

millimeters
(inches)

10-Slot Chassis

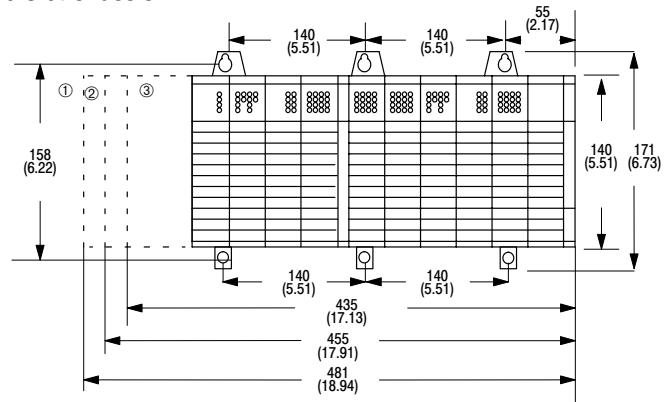

millimeters
(inches)

13-Slot Chassis

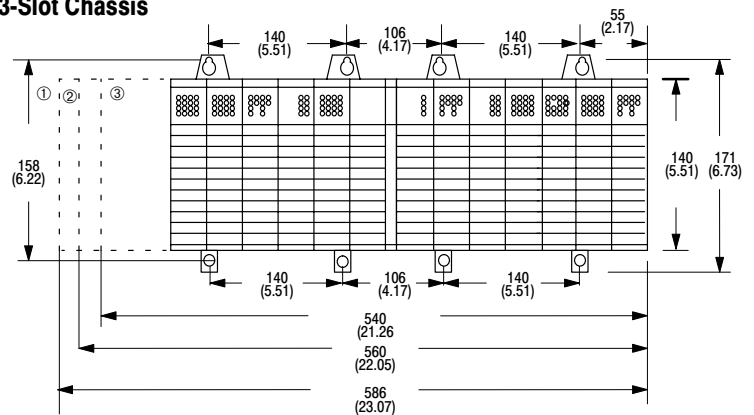

millimeters
(inches)

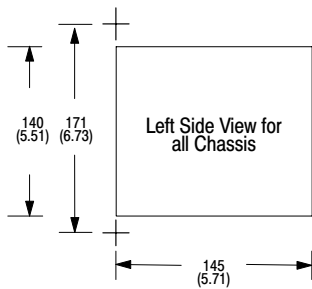

- ① Dimensions include the 1746-P4 power supply.
- ② Dimensions include the 1746-P2 and 1746-P3 power supplies.
- ③ Dimensions include the 1746-P1 power supply.

Data Table Access Module (DTAM, DTAM Plus, DTAM Micro)

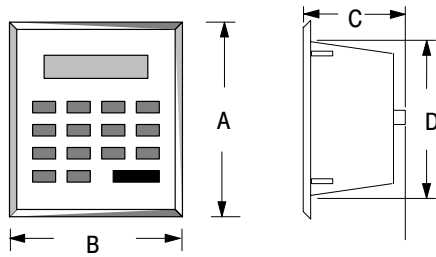

millimeters
(inches)

| | A | B | C | D |
|------------|----------------|----------------|---------------|---------------|
| DTAM | 152 (6.0) | 140 (5.5) | 69 (2.76) | 127 (5.0) |
| DTAM Plus | 215.9 (8.5) | 165.1 (6.5) | 45.7 (1.8) | 193 (7.6) |
| DTAM Micro | 137.2 (5.4) | 175.3 (6.9) | 45.7 (1.8) | 99.1 (3.9) |

Isolated Link Coupler (AIC)

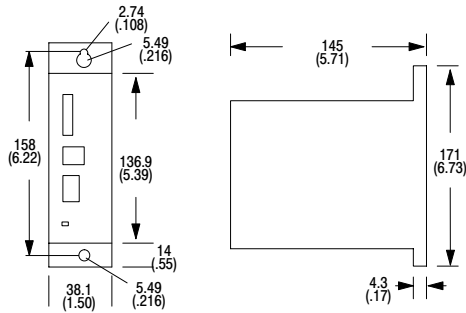

millimeters
(inches)

PanelView 550 Operator Terminal

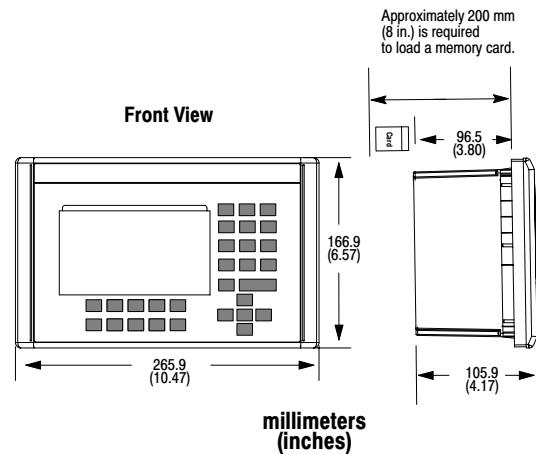

millimeters
(inches)

PanelView 900 Operator Terminal with Function Keys

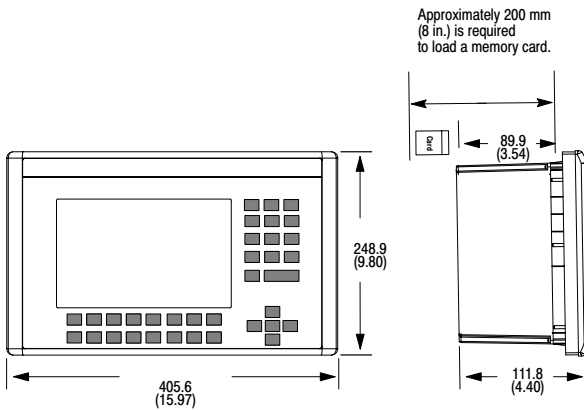

millimeters
(inches)



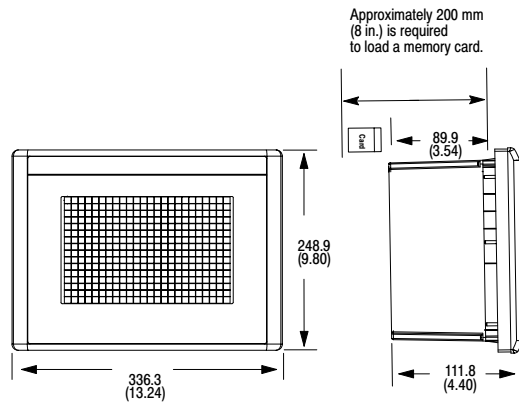







PanelView 900 Operator Terminal with Touch Screen



millimeters
(inches)

Available Cables

Use the following table to help you select the appropriate cable for your application.

| For Connectivity Between These Devices | | This is the Preferred Cable | These Cables May Be Used |
|--|---|-----------------------------|----------------------------------|
| 1746-A4, -A7, -A10, or -A13 Chassis |  1746-A4, -A7, -A10, or -A13 Chassis | 1746-C7 1746-C9 | - |
| 1747-PIC Personal Interface Converter 1747-PT1 Hand-Held Programming Terminal 1747-DTAM-E Data Table Access Module 2707-Lxxx, -Vxxx DTAM Plus |  1747-AIC Isolated Link Coupler SLC 500 Processors (DH-485 Channel) | 1747-C10 | 1747-C11 1747-C20 |
| 1747-AIC Isolated Link Coupler |  SLC 500 Processors (DH-485 Channel) | 1747-C11 | 1747-C10 1747-C13 1747-C20 |
| 1747-KE DH-485/RS-232C Interface Module 1746-BAS BASIC Module |  1747-AIC Isolated Link Coupler | 1747-C13 | 1747-C11 1747-C10 |
| 1746-xx32 32-Point I/O Modules |  1492-IFM40x ^① | 1492-CABLExH ^① | - |
| 1747-L532 5/03 Processor (RS-232 Channel 0) 1747-L542 5/04 Processor (RS-232 Channel 0) |  Personal Computer Serial Port (9-Pin DTE) | 1747-CP3 | - |
| 1746-I/O |  1492-IFMxx Interface Modules ^① | 1492-CABLExx ^① | - |
| 1747-SN Remote I/O Scanner 1747-DCM Direct Communications Module 1747-ASB SLC Remote I/O Adapter Module |  Remote I/O Network | Belden 9463 | - |
| 1747-AIC Isolated Link Coupler 1770-KF3 DH-485 Communication Interface 1784-KR Personal Computer Interface |  1747-AIC Isolated Link Coupler | Belden 9842 | - |
| 1761-L16AWA MicroLogix 1000 Controller 1761-L32AWA MicroLogix 1000 Controller 1761-L16BWA MicroLogix 1000 Controller 1761-L32BWA MicroLogix 1000 Controller 1761-L16BWB MicroLogix 1000 Controller 1761-L32BWB MicroLogix 1000 Controller 1761-L16BBB MicroLogix 1000 Controller 1761-L32BBB MicroLogix 1000 Controller |  IBM compatible PC | 1761-CBL-PM02 | - |

^① For details, refer to the SLC 500 Price List, Publication 1746-3.0.

Publications

For more information on the SLC 500 products discussed in this overview, refer to the following publications. Refer to Publication SD499, Automation Group Publication Index for the most current release.

| Product | Publication |
|---|-------------|
| High-Speed Counter Module | 1746-2.32 |
| BASIC Module and BASIC Development Software | 1746-2.33 |
| Analog I/O Modules | 1746-2.34 |
| Discrete I/O Modules | 1746-2.35 |
| RTD/resistance Input Module (NR4) | 1746-2.37 |
| Stepper Controller Module | 1746-2.39 |
| Modular Chassis and Power Supplies Product Data | 1746-2.38 |
| Thermocouple/mV Input Module (NT4) | 1746-2.36 |
| Bulletin 1746-1747 Price Sheet | 1746-3.0 |
| Direct Communication Module | 1747-2.33 |
| Remote I/O Scanner Module (SN) | 1747-2.34 |
| Distributed I/O Scanner Module (DSN) | 1747-2.35 |
| SLC 500 Class I, Division 2 Certification | 1747-2.36 |
| DH-485/RS-232-C Interface Module (KE) | 1747-2.37 |
| Remote I/O Adapter Module (ASB) | 1747-2.38 |
| SLC 500 Chassis-based Processors | 1747-2.39 |
| MicroLogix 1000 Product Data | 1761-2.1 |
| MicroLogix 1000 Price List | 1761-3.0 |
| DH+/DH-485 Communications Adapter (KA5) | 1785-6.5.5 |

For more information on the non-SLC products discussed in this overview, refer to the following publications.

| Product | Publication |
|------------------------------|-------------|
| Interface Modules and Cables | 1492-1.6 |
| I/O Monitor | 1784-6.5.17 |
| 1791 Block I/O | 1791-1.3 |
| DTAM Plus Operator Interface | 2707-2.0 |
| Flex I/O | 1794-2.1 |
| RediPANEL Operator Modules | 2705-1.0 |
| Dataliner Message Displays | 2706-1.0 |
| PanelView Operator Terminals | 2711-1.1 |
| Drives | DHQ-6 |
| Pyramid Solutions Program | PSP-5.1 |

PLC and PLC-5 are registered trademarks of Allen-Bradley Company, Inc.
SLC, SLC 500, SLC 5/01, SLC 5/02, SLC 5/03, SLC 5/04, MicroLogix, IMC, PanelView, PanelBuilder, RediPANEL, Dataliner, DTAM, DataDisc, DeviceNet, DH+, and Data Highway Plus are trademarks of Allen-Bradley Company, Inc.
IBM is a registered trademark of International Business Machines Corporation.
Microsoft is a registered trademark of Microsoft.
Windows is a trademark of Microsoft.
VERSA is a trademark of Nippon Electric Company Information Systems, Inc.
Gateway 2000 is a trademark of Gateway 2000, Inc.
A.I. Series is a trademark of Rockwell Software Inc.



Allen-Bradley has been helping its customers improve productivity and quality for 90 years. A-B designs, manufactures and supports a broad range of control and automation products worldwide. They include logic processors, power and motion control devices, man-machine interfaces and sensors. Allen-Bradley is a subsidiary of Rockwell International, one of the world's leading technology companies.



With major offices worldwide.

Algeria • Argentina • Australia • Austria • Bahrain • Belgium • Brazil • Bulgaria • Canada • Chile • China, PRC • Colombia • Costa Rica • Croatia • Cyprus • Czech Republic • Denmark • Ecuador • Egypt • El Salvador • Finland • France • Germany • Greece • Guatemala • Honduras • Hong Kong • Hungary • Iceland • India • Indonesia • Israel • Italy • Jamaica • Japan • Jordan • Korea • Kuwait • Lebanon • Malaysia • Mexico • New Zealand • Norway • Oman • Pakistan • Peru • Philippines • Poland • Portugal • Puerto Rico • Qatar • Romania • Russia-CIS • Saudi Arabia • Singapore • Slovakia • Slovenia • South Africa, Republic • Spain • Switzerland • Taiwan • Thailand • The Netherlands • Turkey • United Arab Emirates • United Kingdom • United States • Uruguay • Venezuela • Yugoslavia

World Headquarters, Allen-Bradley, 1201 South Second Street, Milwaukee, WI 53204 USA, Tel: (1) 414 382-2000 Fax: (1) 414 382-4444