



Installation Instructions

ControlLogix™ AC (79-132V) Input Module

Catalog Number 1756- IA16

To:	See page:
Obtain a User Manual	1
Identify the Module Components	4
Note the Power Requirements	5
Install the Module	6
Key the Module and Removable Terminal Block/Interface Module	7
Wire the Module	9
Assemble the Removable Terminal Block and the Housing	10
Install the Removable Terminal Block onto the Module	10
Check the Indicators	11
Remove the Removable Terminal Block from the Module	12
Remove the Module	12
See Specifications	13

Obtain a User Manual

This product also has a user manual (pub. no. 1756-UM058). To view it, visit www.ab.com/manuals or www.theautomationbookstore.com.

To purchase a manual, you can:

- contact your distributor or Rockwell Automation representative
- visit www.theautomationbookstore.com and place an order
- call 800.963.9548 (USA/Canada) or 001.320.725.1574 (outside USA/Canada)

2 ControlLogix™ AC (79-132V) Input Module

Important User Information



Because of the variety of uses for the products described in this publication, those responsible for the application and use of these products must satisfy themselves that all necessary steps have been taken to assure that each application and use meets all performance and safety requirements, including any applicable laws, regulations, codes and standards. In no event will Rockwell Automation be responsible or liable for indirect or consequential damage resulting from the use or application of these products.

Any illustrations, charts, sample programs, and layout examples shown in this publication are intended solely for purposes of example. Since there are many variables and requirements associated with any particular installation, Rockwell Automation does not assume responsibility or liability (to include intellectual property liability) for actual use based upon the examples shown in this publication.

Allen-Bradley publication SGI-1.1, *Safety Guidelines for the Application, Installation and Maintenance of Solid-State Control* (available from your local Rockwell Automation office), describes some important differences between solid-state equipment and electromechanical devices that should be taken into consideration when applying products such as those described in this publication.

Reproduction of the contents of this copyrighted publication, in whole or part, without written permission of Rockwell Automation, is prohibited.

Throughout this publication, notes may be used to make you aware of safety considerations. The following annotations and their accompanying statements help you to identify a potential hazard, avoid a potential hazard, and recognize the consequences of a potential hazard:

WARNING 	Identifies information about practices or circumstances that can cause an explosion in a hazardous environment, which may lead to personal injury or death, property damage, or economic loss.
ATTENTION 	Identifies information about practices or circumstances that can lead to personal injury or death, property damage, or economic loss.
IMPORTANT	Identifies information that is critical for successful application and understanding of the product.

ControlLogix is a trademark of Rockwell Automation, Inc.

Environment and Enclosure

ATTENTION

This equipment is intended for use in a Pollution Degree 2 industrial environment, in overvoltage Category II applications (as defined in IEC publication 60664-1), at altitudes up to 2000 meters without derating. This equipment is considered Group 1, Class A industrial equipment according to IEC/CISPR Publication 11. Without appropriate precautions, there may be potential difficulties ensuring electromagnetic compatibility in other environments due to conducted as well as radiated disturbance. This equipment is supplied as "open type" equipment. It must be mounted within an enclosure that is suitably designed for those specific environmental conditions that will be present and appropriately designed to prevent personal injury resulting from accessibility to live parts. The interior of the enclosure must be accessible only by the use of a tool. Subsequent sections of this publication may contain additional information regarding specific enclosure type ratings that are required to comply with certain product safety certifications.

See NEMA Standards publication 250 and IEC publication 60529, as applicable, for explanations of the degrees of protection provided by different types of enclosure. Also, see the appropriate sections in this publication, as well as the Allen-Bradley publication 1770-4.1 ("Industrial Automation Wiring and Grounding Guidelines"), for additional installation requirements pertaining to this equipment.

Prevent Electrostatic Discharge

ATTENTION

This equipment is sensitive to electrostatic discharge, which can cause internal damage and affect normal operation. Follow these guidelines when you handle this equipment:

- Touch a grounded object to discharge potential static.
- Wear an approved grounding wriststrap.
- Do not touch connectors or pins on component boards.
- Do not touch circuit components inside the equipment.
- If available, use a static-safe workstation.

When not in use, store the equipment in appropriate static-safe packaging.

Removal and Insertion Under Power

WARNING

When you insert or remove the module while backplane power is on, an electrical arc can occur. This could cause an explosion in hazardous location installations. Be sure that power is removed or the area is nonhazardous before proceeding.

Repeated electrical arcing causes excessive wear to contacts on both the module and its mating connector. Worn contacts may create electrical resistance that can affect module operation.

Identify the Module Components

You received the following components with your order:

- 1756-IA16 module
- Removable Terminal Block (RTB) door label

If you did not receive these components, contact your local distributor Rockwell Automation sales office.

This module mounts in a 1756 chassis and uses a separately-ordered RTB or a Bulletin 1492 Interface Module (IFM)⁽¹⁾ to connect all field-side wiring. This module uses one of the following RTBs:

- 1756-TBNH 20 position NEMA RTB
- 1756-TBSH 20 position Spring Clamp RTB

⁽¹⁾ The Bulletin 1492 IFM may not be used in any application that requires agency certification of the ControlLogix system. Use of the IFM violates the UL, CSA and FM certifications of this product.

Use an extended-depth cover (1756-TBE) for applications with heavy gauge wiring or requiring additional routing space. When using an IFM, consult the documentation that came with it to connect wiring.

IMPORTANT

Before you install your module, you should:

- install and ground a 1756 chassis and power supply.
 - order and receive an RTB or IFM, and its components, for your application.
-

Note the Power Requirements

This module receives power from the 1756 chassis power supply and requires 2 sources of power from the backplane:

- 105mA at 5.1V dc
- 2mA at 24V dc

Add this current/power value (0.58W) to the requirements of all other modules in the chassis to prevent overloading the power supply.

Install the Module

You can install or remove the module while chassis power is applied.

WARNING



When you insert or remove the module while backplane power is on, an electrical arc can occur. This could cause an explosion in hazardous location installations. Be sure that power is removed or the area is nonhazardous before proceeding.

1. Align the circuit board with the top and bottom chassis guides.

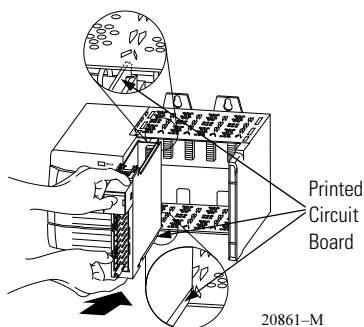

2. Slide the module into the chassis until the module locking tabs click.

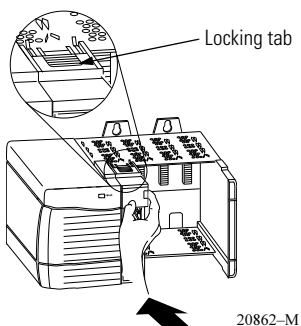

Key the Module and Removable Terminal Block/Interface Module

Use the wedge-shaped keying tabs and U-shaped keying bands to prevent connecting the wrong wires to your module.

Key positions on the module that correspond to unkeyed positions on the RTB. For example, if you key the first position on the module, leave the first position on the RTB unkeyed.

1. To key the module, insert the U-shaped band, as shown.

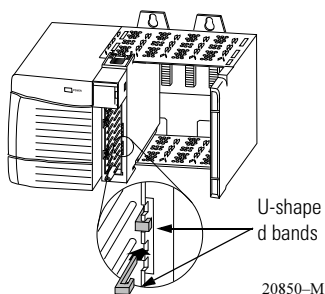

2. Push the band until it snaps in place.
3. To key the RTB or IFM, insert the wedge-shaped tab with rounded edge first, as shown.

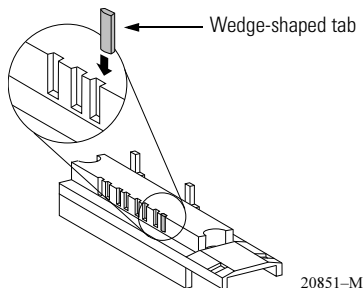

4. Push the tab until it stops.

Reposition the tabs to rekey future module applications.

Wire the Removable Terminal Block

Wire the RTB with a 5/16 inch (8mm) maximum flat-bladed screwdriver before installing it onto the module.

WARNING



When you connect or disconnect the Removable Terminal Block (RTB) with field side power applied, an electrical arc can occur. This could cause an explosion in hazardous location installations. Make sure that power is removed or the area is nonhazardous before proceeding.

Spring Clamp RTB

1. Strip 7/16 inch (11mm) maximum length of wire.
2. Insert the screwdriver into the inner hole of the RTB.

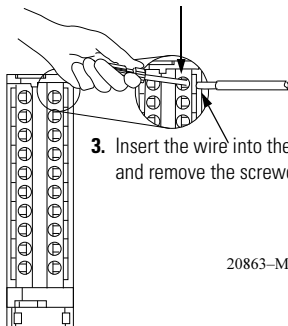

3. Insert the wire into the open terminal and remove the screwdriver.

NEMA Screw RTB

1. Strip 5/16 inch (8mm) maximum length of wire.
2. Turn the terminal screw counterclockwise.
3. Wrap wire around the terminal.
4. Turn the terminal screw clockwise.



Wire the Module

You can only connect wiring to your module through an RTB or IFM. The example below shows how to wire the module.

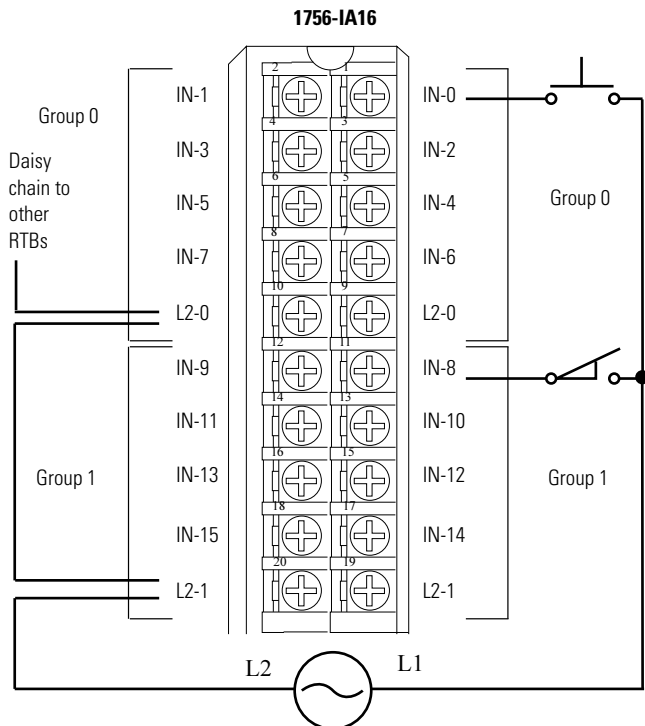

- NOTES: **1.** All terminals with the same name are connected together on the module. For example, L2 can be connected to any terminal marked L2-0.
- 2.** When you daisy chain from a group to another RTB, always connect the daisy chain as shown above. Do not connect more than 2 wires to any single terminal.
- 3.** This wiring example shows a single voltage source.
- 4.** If separate power sources are used, do not exceed the specified isolation voltage.

After completing field-side wiring, secure the wires in the strain relief area with a cable-tie.

Assemble the Removable Terminal Block and the Housing

1. Align the grooves at the bottom of the housing with the side edges of the RTB.

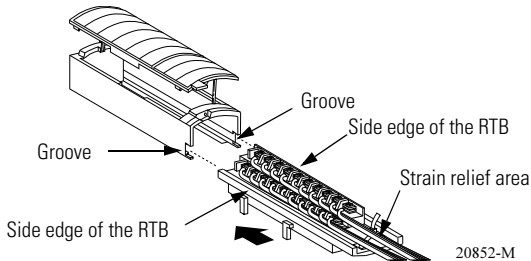

2. Slide the RTB into the housing until it snaps into place.

Install the Removable Terminal Block onto the Module

WARNING



When you connect or disconnect the Removable Terminal Block (RTB) with field side power applied, an electrical arc can occur. This could cause an explosion in hazardous location installations. Be sure that power is removed or the area is nonhazardous before proceeding.

Before installing the RTB, make certain:

- field-side wiring of the RTB has been completed.
- the RTB housing is snapped in place on the RTB.
- the RTB housing is closed.
- the locking tab at the top of the module is unlocked.

1. Align the side and top, bottom guides.
2. Press quickly and evenly to seat the RTB until the latches snap into place.

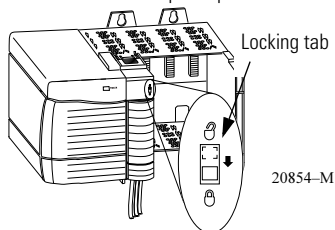
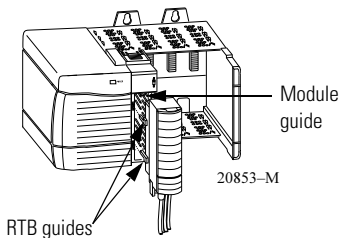

3. To lock the RTB on the module, slide the locking tab down.

Check the Indicators

The indicators show individual I/O status (yellow) for each point and a bi-colored LED for module "OK" (red/green).

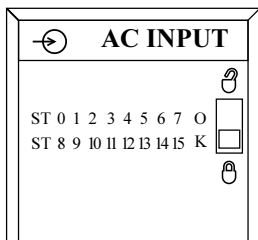

20945-M

During power up, an indicator test is done and the following occurs:

- "OK" indicator turns red for 1 second and then turns to flashing green if it has passed the self-test.
- I/O status indicators turn ON for a maximum of 2 seconds and then turn OFF.

Indicator:	Displaying:	Means:	Take this action:
OK	Steady green light	The inputs are being multicast and in normal operating state.	None
OK	Flashing green light	The module has passed internal diagnostics but is not multicasting inputs.	Configure the module with RSLogix 5000 programming software.
OK	Flashing red light	Previously established communication has timed out.	Check controller and chassis communication.
OK	Steady red light	An unrecoverable error has occurred on the module.	Replace the module.
I/O State	Yellow	The input is active.	None

This completes installation of the module. Use the following information to remove the module, if necessary.

Remove the Removable Terminal Block from the Module

If you need to remove the module, you must remove the RTB first.

WARNING



When you insert or remove the module while backplane power is on, an electrical arc can occur. This could cause an explosion in hazardous location installations. Be sure that power is removed or the area is nonhazardous before proceeding.

Before removing the module, you must remove the RTB.

1. Unlock the locking tab at the top of the module.

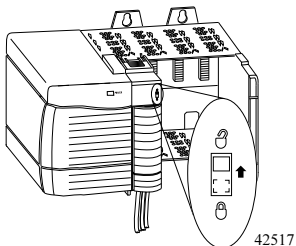

2. Open the RTB door and pull the RTB off the module.

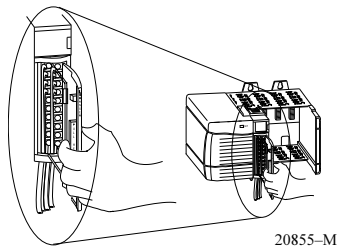

Remove the Module

1. Push in top and bottom locking tabs.

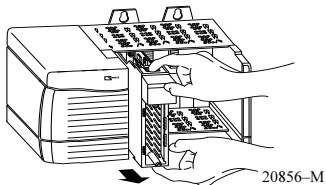

2. Pull module out of the chassis.

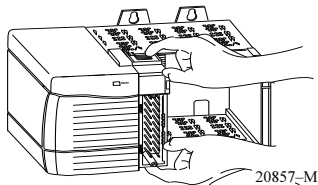

1756-IA16 Specifications

Number of Inputs	16 (8 points/common)
Module Location	1756 ControlLogix Chassis
Backplane Current	105mA @ 5.1V dc & 2mA @ 24V dc (Total backplane power 0.58W)
Maximum Power Dissipation (Module)	5.8W @ 60°C
Thermal Dissipation	18.41 BTU/hr
On-State Voltage Range	74-132V ac, 47-63Hz
Nominal Input Voltage	120V ac
On-State Current	5mA @ 74V ac minimum 13mA @ 132V ac maximum
Maximum Off-State Voltage	20V
Maximum Off-State Current	2.5mA
Maximum Input Impedance @ 132V ac	10.15kΩ @ 60Hz
Input Delay Time	
Off to on	Programmable filter: 1ms & 2ms
Hardware delay	10ms maximum plus filter time
On to off	Programmable filter: 9ms & 18ms
Hardware delay	8ms maximum plus filter time
Diagnostic Functions	
Change of State	Software configurable
Timestamp of Inputs	+/- 200μs
Short/Inrush Current	250mA peak (decaying to <37% in 22ms, without activation)
Change of State on Inputs	Software configurable (Within 200μs)
Cyclic Update Time	User selectable (100μs minimum/750ms maximum)
Isolation Voltage	
Group to group	250V maximum continuous 100% tested at 2546V dc for 1s
User to system	250V maximum continuous 100% tested at 2546V dc for 1s
Module Keying (Backplane)	Software configurable
RTB Screw Torque (NEMA)	7-9 inch-pounds (0.8-1Nm)
RTB Keying	User defined mechanical keying
RTB and Housing	20 Position RTB (1756-TBNH or TBSH)

14 ControlLogix™ AC (79-132V) Input Module

Environmental Conditions	
Operating Temperature	IEC 60068-2-1 (Test Ad, Operating Cold), IEC 60068-2-2 (Test Bd, Operating Dry Heat), IEC 60068-2-14 (Test Nb, Operating Thermal Shock): 0 to 60°C (32 to 140°F)
Storage Temperature	IEC 60068-2-1 (Test Ab, Un-packaged Non-operating Cold), IEC 60068-2-2 (Test Bb, Un-packaged Non-operating Dry Heat), IEC 60068-2-14 (Test Na, Un-packaged Non-operating Thermal Shock): -40 to 85°C (-40 to 185°F)
Relative Humidity	IEC 60068-2-30 (Test Db, Un-packaged Non-operating Damp Heat): 5 to 95% non-condensing
Vibration	IEC60068-2-6 (Test Fc, Operating): 2g @ 10-500Hz
Shock	IEC60068-2-27 (Test Ea, Unpackaged shock): Operating 30g Non-operating 50g
Emissions	CISPR 11: Group 1, Class A
ESD Immunity	IEC 61000-4-2: 6kV contact discharges 8kV air discharges
Radiated RF Immunity	IEC 61000-4-3: 10V/m with 1kHz sine-wave 80%AM from 30MHz to 1000MHz 10V/m with 200Hz 50% Pulse 100%AM at 900Mhz
EFT/B Immunity	IEC 61000-4-4: ±4kV at 2.5kHz on power ports ±4kV at 2.5kHz on signal ports
Surge Transient Immunity	IEC 61000-4-5: ±1kV line-line(DM) and ±2kV line-earth(CM) on power ports (8.10.5) ±1kV line-line(DM) and ±2kV line-earth(CM) on signal ports (8.10.8)
Conducted RF Immunity	IEC 61000-4-6: 10Vrms with 1kHz sine-wave 80%AM from 150kHz to 80MHz
Enclosure Type Rating	None (open-style)



Conductors	Wire Size	#22 to #14 AWG (0.324 to 2.08 sq. mm) stranded ⁽¹⁾ 3/64 inch (1.2mm) insulation maximum
	Category	1 ⁽²⁾ , ⁽³⁾
	Screwdriver Blade Width for RTB	5/16 inch (8mm) maximum
Certifications (when product is marked)		<p>UL UL Listed Industrial Control Equipment</p> <p>CSA CSA Certified Process Control Equipment</p> <p>CSA CSA Certified Process Control Equipment for Class I, Division 2 Group A,B,C,D Hazardous Locations</p> <p>FM FM Approved Equipment for use in Class I Division 2 Group A,B,C,D Hazardous Locations</p> <p>CE⁽⁴⁾ European Union 89/336/EEC EMC Directive, compliant with: EN 50082-2; Industrial Immunity EN 61326; Meas./Control/Lab., Industrial Requirements EN 61000-6-2; Industrial Immunity EN 61000-6-4; Industrial Emissions</p> <p>European Union 73/23/EEC LVD Directive, compliant with: EN 61131-2; Programmable Controllers</p> <p>C-Tick⁽⁴⁾ Australian Radiocommunications Act, compliant with: AS/NZS 2064; Industrial Emissions</p>

(1) Maximum wire size requires extended housing - 1756-TBE.

(2) Use this conductor category information for planning conductor routing as described in the system level installation manual.

(3) Refer to publication 1770-4.1 *Industrial Automation Wiring and Grounding Guidelines*.

(4) See the Product Certification link at www.ab.com for Declarations of Conformity, Certificates, and other certification details.

<p>The following information applies when operating this equipment in hazardous locations:</p>	<p>Informations sur l'utilisation de cet équipement en environnements dangereux :</p>
<p>Products marked "CL I, DIV 2, GP A, B, C, D" are suitable for use in Class I Division 2 Groups A, B, C, D, Hazardous Locations and nonhazardous locations only. Each product is supplied with markings on the rating nameplate indicating the hazardous location temperature code. When combining products within a system, the most adverse temperature code (lowest "T" number) may be used to help determine the overall temperature code of the system. Combinations of equipment in your system are subject to investigation by the local Authority Having Jurisdiction at the time of installation.</p>	<p>Les produits marqués "CL I, DIV 2, GP A, B, C, D" ne conviennent qu'à une utilisation en environnements de Classe I Division 2 Groupes A, B, C, D dangereux et non dangereux. Chaque produit est livré avec des marquages sur sa plaque d'identification qui indiquent le code de température pour les environnements dangereux. Lorsque plusieurs produits sont combinés dans un système, le code de température le plus défavorable (code de température le plus faible) peut être utilisé pour déterminer le code de température global du système. Les combinaisons d'équipements dans le système sont sujettes à inspection par les autorités locales qualifiées au moment de l'installation.</p>
<p>WARNING</p>  <p>EXPLOSION HAZARD</p> <ul style="list-style-type: none"> Do not disconnect equipment unless power has been removed or the area is known to be nonhazardous. Do not disconnect connections to this equipment unless power has been removed or the area is known to be nonhazardous. Secure any external connections that mate to this equipment by using screws, sliding latches, threaded connectors, or other means provided with this product. Substitution of components may impair suitability for Class I, Division 2. If this product contains batteries, they must only be changed in an area known to be nonhazardous. 	<p>AVERTISSEMENT</p>  <p>RISQUE D'EXPLOSION</p> <ul style="list-style-type: none"> Couper le courant ou s'assurer que l'environnement est classé non dangereux avant de débrancher l'équipement. Couper le courant ou s'assurer que l'environnement est classé non dangereux avant de débrancher les connecteurs. Fixer tous les connecteurs externes reliés à cet équipement à l'aide de vis, loquets coulissants, connecteurs filetés ou autres moyens fournis avec ce produit. La substitution de composants peut rendre cet équipement inadapté à une utilisation en environnement de Classe I, Division 2. S'assurer que l'environnement est classé non dangereux avant de changer les piles.

www.rockwellautomation.com

Corporate Headquarters

Rockwell Automation, 777 East Wisconsin Avenue, Suite 1400, Milwaukee, WI, 53202-5302 USA, Tel: (1) 414.212.5200, Fax: (1) 414.212.5201

Headquarters for Allen-Bradley Products, Rockwell Software Products and Global Manufacturing Solutions

Americas: Rockwell Automation, 1201 South Second Street, Milwaukee, WI 53204-2496 USA, Tel: (1) 414.382.2000, Fax: (1) 414.382.4444

Europe: Rockwell Automation SA/NV, Vorstlaan/Boulevard du Souverain 36-BP 3A/B, 1170 Brussels, Belgium, Tel: (32) 2 663 0600, Fax: (32) 2 663 0640

Asia Pacific: Rockwell Automation, 27/F Citicorp Centre, 18 Whitfield Road, Causeway Bay, Hong Kong, Tel: (852) 2887 4788, Fax: (852) 2508 1846

Headquarters for Dodge and Reliance Electric Products

Americas: Rockwell Automation, 6040 Ponders Court, Greenville, SC 29615-4617 USA, Tel: (1) 864.297.4800, Fax: (1) 864.281.2433

Europe: Rockwell Automation, Brühlstraße 22, D-74834 Elztal-Dallau, Germany, Tel: (49) 6261 9410, Fax: (49) 6261 17741

Asia Pacific: Rockwell Automation, 55 Newton Road, #11-01/02 Revenue House, Singapore 307987, Tel: (65) 351 6723, Fax: (65) 355 1733

Publication 1756-IN029D-EN-P - February 2003

PN 957726-56

Supersedes Publication 1756-IN029C-EN-P - October 2000

Copyright © 2003 Rockwell Automation. All rights reserved. Printed in the U.S.A.