

Installation Instructions

ControlLogix Controller and Memory Board

Catalog Numbers 1756-L1, 1756-L1M1, 1756-L1M2, 1756-L1M3, 1756-L55, 1756-L55M12, 1756-L55M13, 1756-L55M14, 1756-L55M16, 1756-L55M22, 1756-L55M23, 1756-L55M24, 1756-L61, 1756-L62, 1756-L63, 1756-L64, 1756-L65, 1756-M1, 1756-M2, 1756-M3, 1756-M12, 1756-M13, 1756-M14, 1756-M16, 1756-M22, 1756-M23, 1756-M24, 1784-CF64, 1784-CF128

Topic	Page
Important User Information	3
Explosion Hazards	4
Preventing Electrostatic Discharge	4
Removing Module While Under Power (RIUP)	4
Environment and Enclosure	5
North American Hazardous Location Approval	6
European Hazardous Location Approval	7
Before You Begin	8
Replace a Suspected Failed Controller	9
Resolving Common Errors	11

2 ControlLogix Controller and Memory Board

Topic	Page
Required System Components	12
Firmware Revisions	14
Preparing the Chassis	16
Remove the Controller from the Chassis	16
Installing a Memory Board on a ControlLogix5550 or ControlLogix5555 Controller	17
Installing a CompactFlash Card in a Controller	22
Connecting a Battery	25
Installing the Controller into the Chassis	28
Check the BAT Status Indicator	29
Checking the OK Status Indicator	30
Update the Controller	32
Connecting a Serial Cable	34
Interpreting the Status Indicators	36
Clear a Major Fault	38
Clear a Nonrecoverable Fault	39
Choosing the Operating Mode of the Controllers	40
Specifications	41

Important User Information

Solid state equipment has operational characteristics differing from those of electromechanical equipment. Safety Guidelines for the Application, Installation and Maintenance of Solid State Controls ([Publication SGI-1.1](#) available from your local Rockwell Automation sales office or online at <http://literature.rockwellautomation.com>) describes some important differences between solid state equipment and hard-wired electromechanical devices. Because of this difference, and also because of the wide variety of uses for solid state equipment, all persons responsible for applying this equipment must satisfy themselves that each intended application of this equipment is acceptable.





In no event will Rockwell Automation, Inc. be responsible or liable for indirect or consequential damages resulting from the use or application of this equipment.

The examples and diagrams in this manual are included solely for illustrative purposes. Because of the many variables and requirements associated with any particular installation, Rockwell Automation, Inc. cannot assume responsibility or liability for actual use based on the examples and diagrams.

No patent liability is assumed by Rockwell Automation, Inc. with respect to use of information, circuits, equipment, or software described in this manual.

Reproduction of the contents of this manual, in whole or in part, without written permission of Rockwell Automation, Inc., is prohibited.

Throughout this manual, when necessary, we use notes to make you aware of safety considerations.

<p>WARNING</p> 	<p>Identifies information about practices or circumstances that can cause an explosion in a hazardous environment, which may lead to personal injury or death, property damage, or economic loss.</p>
<p>IMPORTANT</p>	<p>Identifies information that is critical for successful application and understanding of the product.</p>
<p>ATTENTION</p> 	<p>Identifies information about practices or circumstances that can lead to personal injury or death, property damage, or economic loss. Attentions help you identify a hazard, avoid a hazard and recognize the consequences.</p>
<p>SHOCK HAZARD</p> 	<p>Labels may be on or inside the equipment (for example, a drive or motor) to alert people that dangerous voltage may be present.</p>
<p>BURN HAZARD</p> 	<p>Labels may be on or inside the equipment (for example, a drive or motor) to alert people that surfaces may reach dangerous temperatures.</p>

Explosion Hazards

WARNING

An electrical arc can occur if you:

- insert or remove the CompactFlash card.
- insert or remove the controller while backplane power is on.
- connect or disconnect the battery.
- connect or disconnect the serial cable with power applied to this module or the serial device on the other end of the cable.

This could cause an explosion in hazardous location installations. Make sure that power is removed or the area is nonhazardous before proceeding

Preventing Electrostatic Discharge

ATTENTION

This equipment is sensitive to electrostatic discharge, which can cause internal damage and affect normal operation. Follow these guidelines when you handle this equipment.

- Touch a grounded object to discharge potential static.
 - Wear an approved grounding wriststrap.
 - Do not touch connectors or pins on component boards.
 - Do not touch circuit components inside the equipment.
 - Use a static-safe workstation, if available.
 - Store the equipment in appropriate static-safe packaging when not in use.
-

Removing Module While Under Power (RIUP)

WARNING

When you insert or remove the module while backplane power is on, an electrical arc can occur. This could cause an explosion in hazardous location installations.

Be sure that power is removed or the area is nonhazardous before proceeding. Repeated electrical arcing causes excessive wear to contacts on both the module and its mating connector. Worn contacts may create electrical resistance that can affect module operation.

Environment and Enclosure

ATTENTION

This equipment is intended for use in a Pollution Degree 2 industrial environment, in overvoltage Category II applications (as defined in IEC publication 60664-1), at altitudes up to 2000 m (6561 ft) without derating.



This equipment is considered Group 1, Class A industrial equipment according to IEC/CISPR Publication 11. Without appropriate precautions, there may be potential difficulties ensuring electromagnetic compatibility in other environments due to conducted as well as radiated disturbance.

This equipment is supplied as open-type equipment. It must be mounted within an enclosure that is suitably designed for those specific environmental conditions that will be present and appropriately designed to prevent personal injury resulting from accessibility to live parts. The enclosure must have suitable flame-retardant properties to prevent or minimize the spread of flame, complying with a flame spread rating of 5VA, V2, V1, V0 (or equivalent) if non-metallic. The interior of the enclosure must be accessible only by the use of a tool. Subsequent sections of this publication may contain additional information regarding specific enclosure type ratings that are required to comply with certain product safety certifications.

In addition to this publication, see:

- Industrial Automation Wiring and Grounding Guidelines, for additional installation requirements, Allen-Bradley publication [1770-4.1](#).
 - NEMA Standards publication 250 and IEC publication 60529, as applicable, for explanations of the degrees of protection provided by different types of enclosure.
-

North American Hazardous Location Approval

<p>The following information applies when operating this equipment in hazardous locations.</p>	<p>Informations sur l'utilisation de cet équipement en environnements dangereux.</p>
<p>Products marked "CL I, DIV2, GP A, B, C, D" are suitable for use in Class I Division 2 Groups A, B, C, D, Hazardous Locations and nonhazardous locations only. Each product is supplied with markings on the rating nameplate indicating the hazardous location temperature code. When combining products within a system, the most adverse temperature code (lowest "T" number) may be used to help determine the overall temperature code of the system. Combinations of equipment in your system are subject to investigation by the local Authority Having Jurisdiction at the time of installation.</p>	<p>Les produits marqués "CL I, DIV 2, GP A, B, C, D" ne conviennent qu'à une utilisation en environnements de Classe I Division 2 Groupes A, B, C, D dangereux et non dangereux. Chaque produit est livré avec des marquages sur sa plaque d'identification qui indiquent le code de température pour les environnements dangereux. Lorsque plusieurs produits sont combinés dans un système, le code de température le plus défavorable (code de température le plus faible) peut être utilisé pour déterminer le code de température global du système. Les combinaisons d'équipements dans le système sont sujettes à inspection par les autorités locales qualifiées au moment de l'installation.</p>
<p>WARNING</p> 	<p>EXPLOSION HAZARD -</p> <ul style="list-style-type: none"> • Do not disconnect equipment unless power has been removed or the area is known to be nonhazardous. • Do not disconnect connections to this equipment unless power has been removed or the area is known to be nonhazardous. Secure any external connections that mate to this equipment by using screws, sliding latches, threaded connectors, or other means provided with this product. • Substitution of components may impair suitability for Class I, Division 2. • If this product contains batteries, they must only be changed in an area known to be nonhazardous.
<p>AVERTISSEMENT</p> 	<p>RISQUE D'EXPLOSION –</p> <ul style="list-style-type: none"> • Couper le courant ou s'assurer que l'environnement est classé non dangereux avant de débrancher l'équipement. • Couper le courant ou s'assurer que l'environnement est classé non dangereux avant de débrancher les connecteurs. Fixer tous les connecteurs externes reliés à cet équipement à l'aide de vis, loquets coulissants, connecteurs filetés ou autres moyens fournis avec ce produit. • La substitution de composants peut rendre cet équipement inadapté à une utilisation en environnement de Classe I, Division 2. • S'assurer que l'environnement est classé non dangereux avant de changer les piles.

European Hazardous Location Approval

European Zone 2 Certification (The following applies when the product bears the Ex or EEx Marking)

This equipment is intended for use in potentially explosive atmospheres as defined by European Union Directive 94/9/EC.

The LCIE (Laboratoire Central des Industries Electriques) certifies that this equipment has been found to comply with the Essential Health and Safety Requirements relating to the design and construction of Category 3 equipment intended for use in potentially explosive atmospheres, given in Annex II to this Directive.

Compliance with the Essential Health and Safety Requirements has been assured by compliance with EN 60079-15.

ATTENTION

This equipment is not resistant to sunlight or other sources of UV radiation.



WARNING

- This equipment must be used only with ATEX certified backplanes.
 - Secure any external connections that mate to this equipment by using screws, sliding latches, threaded connectors, or other means provided with this product.
 - Do not disconnect equipment unless power has been removed or the area is known to be nonhazardous.
 - Equipment must be installed in an enclosure providing at least IP54 protection when applied in Class I, Zone 2 environments.
 - This equipment shall be used within its specified ratings defined by Allen-Bradley.
-



Before You Begin

Read this section for important information about using these products, noting that this publication covers the products shown in the table.

Product	Cat. No.	Series
ControlLogix5550 controller	1756-L1, 1756-L1M1, 1756-L1M2, 1756-L1M3	A
ControlLogix5555 controller	1756-L55, 1756-L55M12, 1756-L55M13, 1756-L55M14, 1756-L55M16, 1756-L55M22, 1756-L55M23, 1756-L55M24	A
ControlLogix5561 controller	1756-L61	A, B
ControlLogix5562 controller	1756-L62	A, B
ControlLogix5563 controller	1756-L63	A, B
ControlLogix5564 controller	1756-L64	B
ControlLogix5565 controller	1756-L65	B
ControlLogix5550 memory board	1756-M1, 1756-M2, 1756-M3	A
ControlLogix5555 memory board	1756-M12, 1756-M13, 1756-M14, 1756-M16, 1756-M22, 1756-M23, 1756-M24	A
Industrial CompactFlash card	1784-CF64, 1784-CF128	A

Replace a Suspected Failed Controller

To replace a failed controller, do the following.

1. Cycle power to the chassis.
2. Make sure the OK status indicator is solid red, noting that if the OK status indicator is not solid red, the controller does not require replacement.
3. Match the catalog numbers of the controllers and memory boards, noting that 1756-Mxxx is the catalog number of the memory board, if one is installed, and 1756-Lxxx is the catalog number of the controller, as shown in the figure.

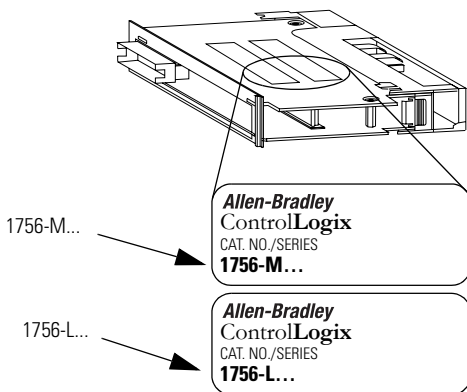
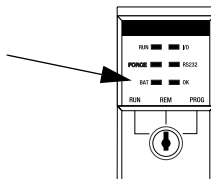

4. Insert the battery.

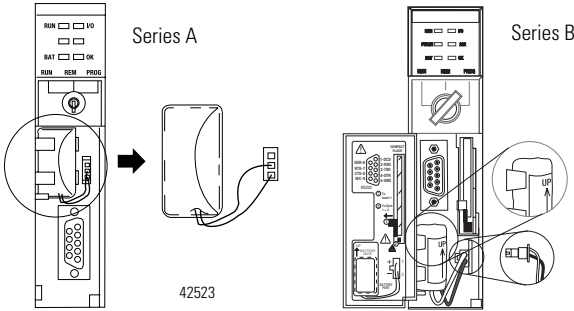

5. Insert the key, and turn it to the PROG position.

6. Insert the controller into the chassis.

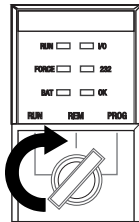
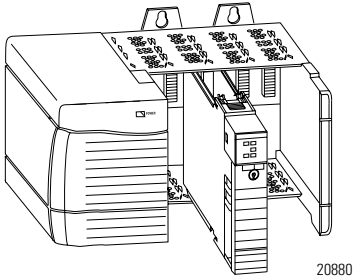

7. Use ControlFlash software to update the firmware of the controller.
8. Download the RSLogix 5000 project to the controller.

Resolving Common Errors

IMPORTANT

Before you change a memory board, update the controller to a revision that is compatible with the memory board that you intend to install. Make sure you use the correct firmware revision.



To resolve common errors, see the following table. For more information on how to avoid these common errors, refer to the [Memory Board](#) table or [Firmware Revisions](#) section.

Common Errors

Controller	Be sure that you
All	Update the firmware of the controller to the revision that is compatible with your RSLogix 5000 software. Controllers ship with firmware that lets you only update them.
ControlLogix5550	Use the correct memory board (one per controller).
ControlLogix5555	<ul style="list-style-type: none"> • If you purchased a ControlLogix5555 controller without a memory board, you must install a memory board. • Use the correct memory board (one per controller). • Use the correct firmware revision.
ControlLogix5561 ControlLogix5562 ControlLogix5563 ControlLogix5564 ControlLogix5565	<ul style="list-style-type: none"> • Do not install a memory board. • Make sure you use the correct firmware revision.

Required System Components

These components ship with the controller.



Component	Description
	Series A controllers: 1756-BA1 battery
	Series B controllers: 1756-BA2 battery
	Key

You can use these components with the controller.

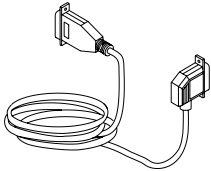

IMPORTANT

To maintain memory longer than is available with the battery, this option maintains memory only while the controller is in the chassis.

Optional Components

Description	Controller	Component
Connect a device to the serial port of the controller (for example, connect a computer to the controller)		1756-CP3 serial cable. 
Increase the memory of the controller	ControlLogix5550 ControlLogix5555	Memory board. 
	ControlLogix5561 ControlLogix5562 ControlLogix5563 ControlLogix5564 ControlLogix5565	Not available for this controller.

Optional Components

Description	Controller	Component
Add nonvolatile memory	ControlLogix5550	Not available for this controller.
	ControlLogix5555	Memory board. 
	ControlLogix5561 ControlLogix5562 ControlLogix5563 ControlLogix5564 ControlLogix5565	1784-CF64 Industrial CompactFlash Card.  31376-M
Maintain memory longer than is available with the battery	ControlLogix5550	Not available for this controller.
	ControlLogix5555 ControlLogix5561 Series A ControlLogix5562 Series A ControlLogix5563 Series A	1756-BATM ControlLogix battery module.  31298
	ControlLogix5561 Series B ControlLogix5562 Series B ControlLogix5563 Series B ControlLogix5564 Series B ControlLogix5565 Series B	Not available for this controller ⁽¹⁾ .

⁽¹⁾ Series B controllers use the battery differently than previous controllers. Battery life depends on chassis temperature, project size, and how often you cycle power. Battery life **no longer** depends on whether or not the controller has power.

Memory Board

Controller	Memory Board	
ControlLogix5550	1756-M1, 1756-M2, 1756-M3	
ControlLogix5555	No nonvolatile memory	1756-M12, 1756-M13, 1756-M14, 1756-M16
	Nonvolatile memory	1756-M22, 1756-M23, 1756-M24
ControlLogix5561	Do not install a memory board.	
ControlLogix5562		
ControlLogix5563		
ControlLogix5564		
ControlLogix5565		

Firmware Revisions

To update the firmware of a controller, install a firmware upgrade kit. An upgrade kit ships on a supplemental CD along with RSLogix 5000 software. To download an upgrade kit, go to <http://www.ab.com> and select Product Support and Firmware Updates.

Use the following table to determine which firmware revisions to use with your controller and memory board combination.

Controller and Memory Board Combinations

Controller and Memory Board	Series	Use this revision or later	
1756-L1	None	Any.	
1756-L1M1			
1756-L1M2			
1756-L1M3			
1756-L55M12		10.x or later.	
1756-L55M13		6.x or later.	
1756-L55M14			
1756-L55M16			
1756-L55M22		10.x or later.	
1756-L55M23		8.x or later.	
1756-L55M24			
1756-L61	A	12.x or later.	
	B	13.40 or later.	
1756-L62	A	12.x or later.	
	B	13.40 or later.	
1756-L63	A	No CompactFlash card	10.x or later.
		CompactFlash card	11.x or later.
	B	13.40 or later.	
1756-L64	B	16 or later.	
1756-L65	B	17 or later.	

Make sure that the firmware revision is compatible with your version of RSLogix 5000 software.

Preparing the Chassis

Before you install a controller:

- install a ControlLogix chassis.
- install a ControlLogix power supply.

Remove the Controller from the Chassis

You can install or remove a controller while chassis power is on and the system is operating. If you remove the controller, all the devices owned by the controller go to their configured fault state.

WARNING

When you insert or remove the module while backplane power is on, an electrical arc can occur. This could cause an explosion in hazardous location installations. Be sure that power is removed or the area is nonhazardous before proceeding.

Repeated electrical arcing causes excessive wear to contacts on both the module and its mating connector. Worn contacts may create electrical resistance that can affect module operation.

1. Press the locking tabs on the top and bottom of the controller.
2. Slide the controller out of the chassis.

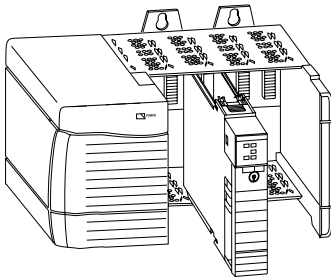

20880

Installing a Memory Board on a ControlLogix5550 or ControlLogix5555 Controller

ATTENTION



Before you install or replace the memory board, disconnect the battery from the controller. Otherwise, you may damage the memory board.

WARNING



When you connect or disconnect the battery an electrical arc can occur. This could cause an explosion in hazardous location installations. Be sure that power is removed or the area is nonhazardous before proceeding. For Safety information on the handling of lithium batteries, including handling and disposal of leaking batteries, see Guidelines for Handling Lithium Batteries, publication [AG-5-4-NOV04](#).

If your ControlLogix5550 or ControlLogix5555 controller requires a different memory board, install or replace the board as described. The tools required are:

- #2 Philips screwdriver
- grounding wriststrap

Before you replace the memory board, determine if you must update the controller firmware.

Update the Controller Firmware

Controller	Replacing Memory Board with	Action
ControlLogix5550		No update is required at this time.
ControlLogix5555	Same catalog number of memory board	No update is required at this time.
	Different catalog number of memory board For example, you are replacing a 1756-M13 memory board with a 1756-M23 memory board	Before you replace the board update the firmware of the controller to a revision that is compatible with the memory board that you will install.

Remove the Side Plate of the Controller

1. Lay the controller on its side with the label facing up.
2. Remove the two screws that attach the side plate to the controller while wearing a grounding wriststrap.
3. Rotate the side plate (A) up and unhook it from the controller, as shown in the figure.

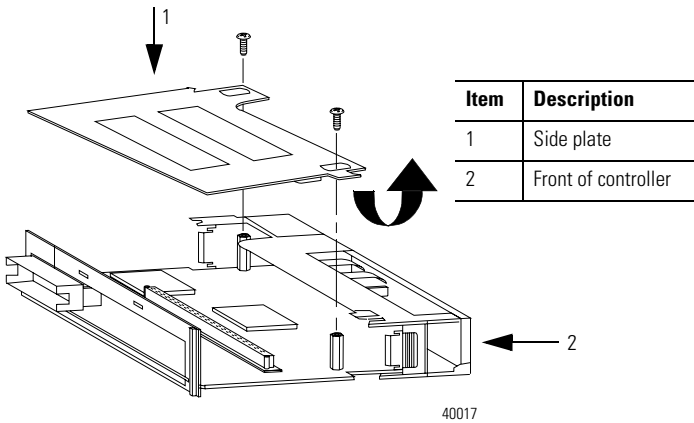

Remove the Existing Memory Board

If the controller does not already have a memory board, as shown in the figure, refer to the [Install the Memory Board](#) section.

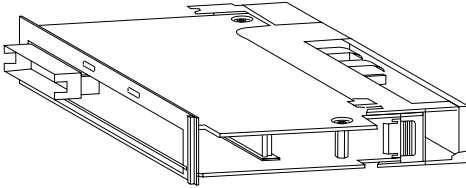

42527

1. Pull the plastic back edge of the controller out slightly to clear the tabs on the memory board.

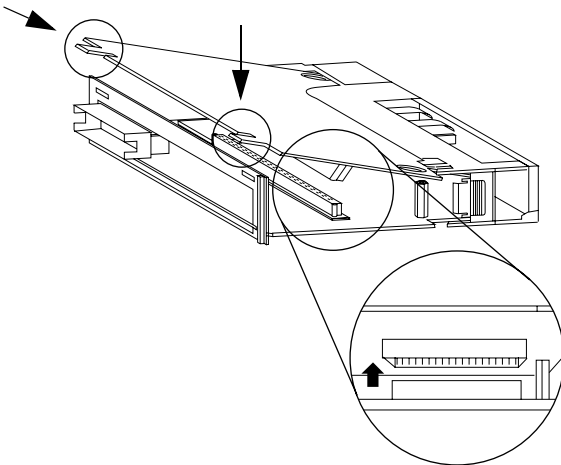

42526

2. Gently separate and remove the memory board from the controller.

Install the Memory Board

1. Place the memory board over the connector and slide the memory board into the controller.

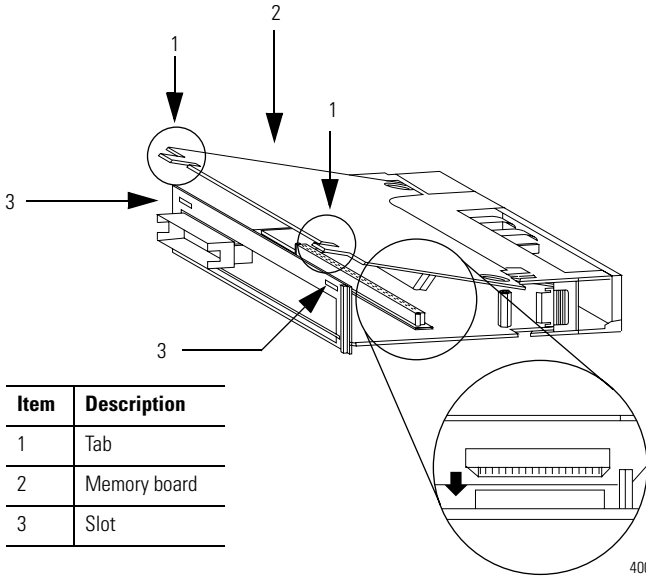

2. Pull the plastic back edge of the controller out slightly to clear the tabs of the memory board.
3. Line up the connectors.
4. Place your hands on the boards over the connectors and gently squeeze them together.
5. Make sure that the tabs on the memory board extend through the slots on the plastic housing of the controller.

Replace the Side Plate

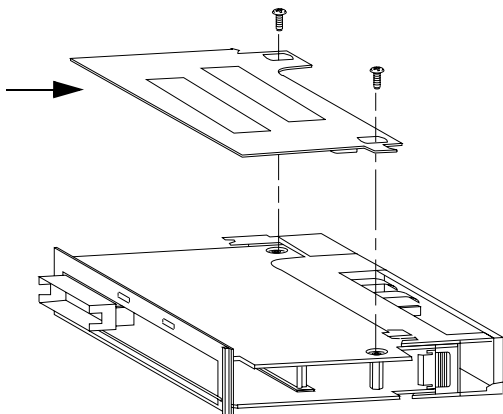

40019

1. Line up the hinge tabs on the side plate with the slots in the plastic housing of the controller.
2. Gently press the side plate against the controller.
3. Replace the screws.

Attach Labels

To identify which memory board is installed, place the memory board label on the side of the controller.

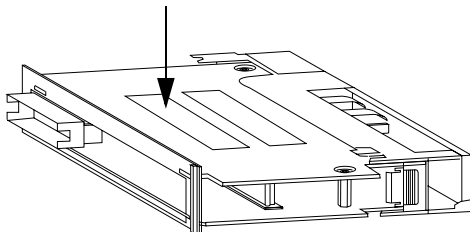

40019

Installing a CompactFlash Card in a Controller

A 1784-CF64 or 1784-CF128 Industrial CompactFlash Card provides nonvolatile memory for a ControlLogix5561, ControlLogix5562, ControlLogix5563, ControlLogix5564, or a ControlLogix5565 controller.

Install a CompactFlash Card in a Series A Controller

1. Lay the controller on its side with the front facing to the left.
2. Raise the locking clip all the way up.
3. Insert the CompactFlash card into the socket at the bottom of the controller.
4. Pull the clip forward and then downward until it snaps into place over the card.

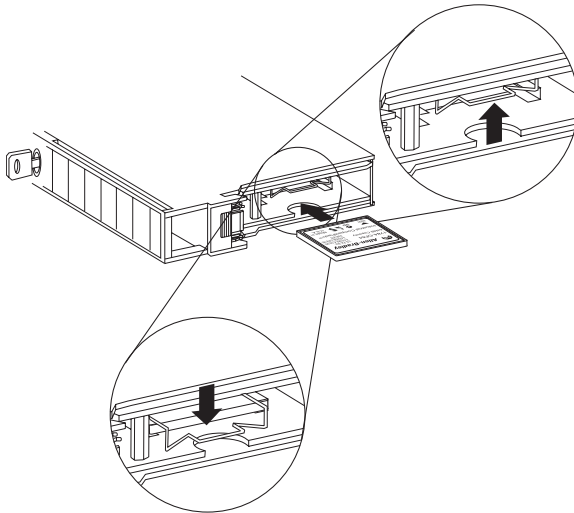

*Install a CompactFlash Card in a Series B Controller***WARNING**

When you insert or remove the CompactFlash card an electrical arc can occur. This could cause an explosion in hazardous location installations. Be sure that power is removed or the area is nonhazardous before proceeding.

ATTENTION

If you are **not** sure of the contents of the CompactFlash card, **before** you install the card turn the keyswitch of the controller to the PROG position. Depending on the contents of the card, a power cycle or fault could cause the card to load a different project into the controller.

1. Turn the keyswitch to the PROG position.
2. Open the door of the controller.
3. Push the CompactFlash latch to the left.
4. Insert the CompactFlash card with the A-B ISogo pointing left.
5. Release the latch and make sure it slides over the CompactFlash card.

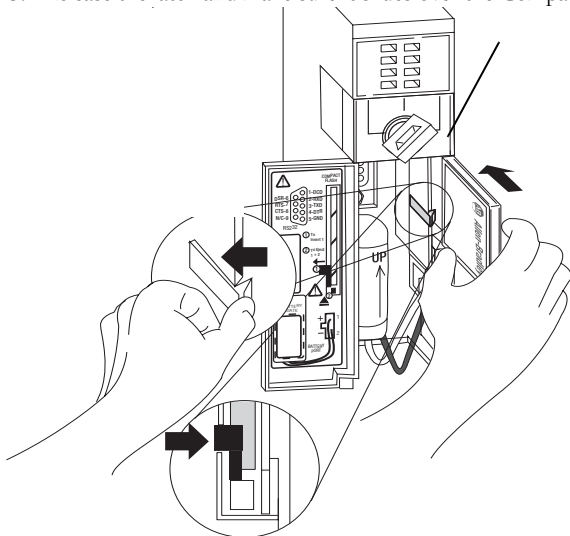

Remove a CompactFlash Card from a Series B Controller

WARNING



When you insert or remove the CompactFlash card an electrical arc can occur. This could cause an explosion in hazardous location installations. Be sure that power is removed or the area is nonhazardous before proceeding.

1. If the OK status indicator is flashing green, wait until it turns solid green.

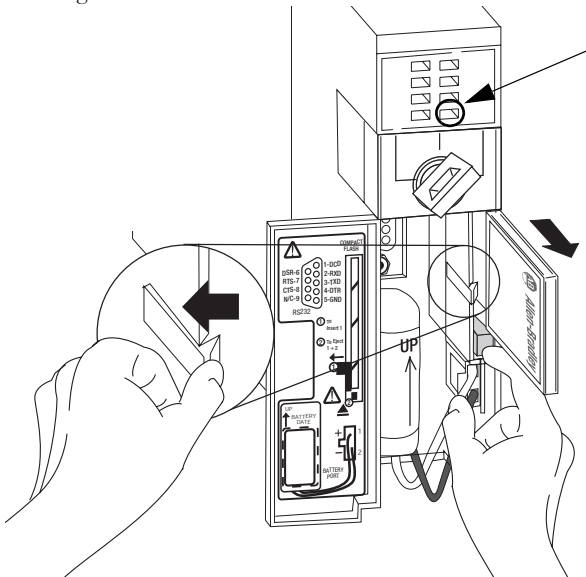

2. Open the door of the controller.
3. Push and hold the CompactFlash latch to the left.
4. Push the eject button and remove the card.
5. Release the latch.

Connecting a Battery

WARNING



When you connect or disconnect the battery an electrical arc can occur. This could cause an explosion in hazardous location installations. Be sure that power is removed or the area is nonhazardous before proceeding. For Safety information on the handling of lithium batteries, including handling and disposal of leaking batteries, see Guidelines for Handling Lithium Batteries, publication [AG-5-4-NOV04](#).

ATTENTION



To prevent possible battery leakage, even if the BAT status indicator is off, replace a 1756-BA1 or 1756-BA2 battery according to the following schedule.

If the temperature 1 in. below the chassis is	Replace the battery within
0...35 °C (32...95 °F)	No required replacement.
36...40 °C (96.8...104 °F)	3 years.
41...45 °C (105.8...113 °F)	2 years.
46...50 °C (114.8...122 °F)	16 months.
51...55 °C (123.8...131 °F)	11 months.
56...60 °C (132.8...140 °F)	8 months.

ATTENTION



Store batteries in a cool, dry environment. We recommend 25 °C (77 °F) with 40...60% relative humidity. You may store batteries for up to 30 days between -45...85 °C (-49...185 °F), such as during transportation. To avoid leakage or other hazards, **do not** store batteries above 60 °C (140 °F) for more than 30 days.

Install a Battery in a Series A Controller

ATTENTION

For a series A controller, connect only a 1756-BA1 battery or a 1756-BATM battery module. Other batteries may damage the controller.



1. Insert and connect the battery as shown.
2. Write the date on the battery label.
3. Attach the label to the inside of the controller door.

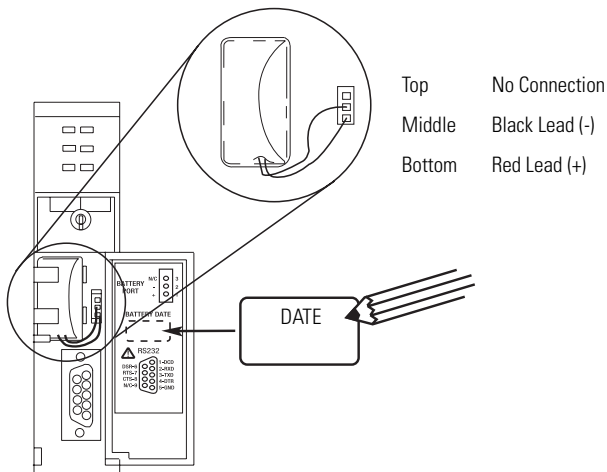

*Install a Battery in a Series B Controller***ATTENTION**

For a series B controller, connect only a 1756-BA2 battery. Other batteries may damage the controller.

1. Insert the battery with the arrow pointing up as shown.
2. Connect the battery: **+ Red, - Black.**
3. Write the date on the battery label.
4. Attach the label to the inside of the controller door.

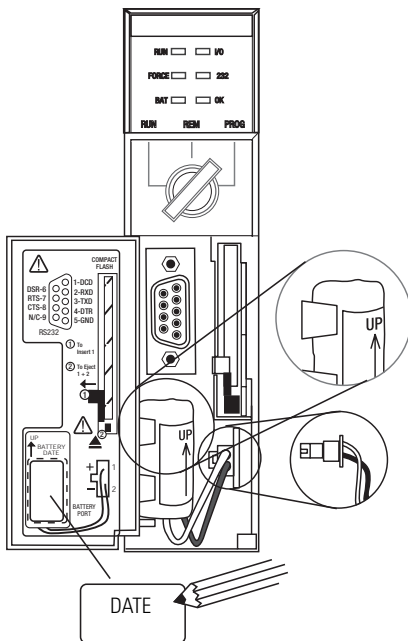

Installing the Controller into the Chassis

When you install a ControlLogix controller, you can:

- place the controller in any slot.
- use multiple controllers in the same chassis.

You can install or remove a ControlLogix controller while chassis power is on and the system is operating.

WARNING



When you insert or remove the module while backplane power is on, an electrical arc can occur. This could cause an explosion in hazardous location installations. Be sure that power is removed or the area is nonhazardous before proceeding.

Repeated electrical arcing causes excessive wear to contacts on both the module and its mating connector. Worn contacts may create electrical resistance that can affect module operation.

1. Insert the key into the controller.
2. Turn the key to the PROG position.
3. Align the circuit board with the top and bottom guides in the chassis.
4. Slide the module into the chassis, making sure it is flush with the power supply or other modules and the top and bottom latches are engaged.

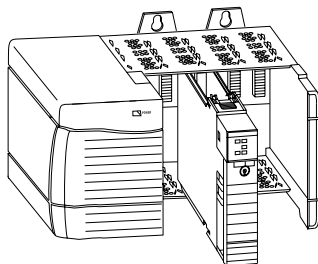
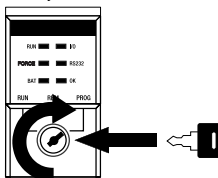

Check the BAT Status Indicator

1. Turn on the chassis power.

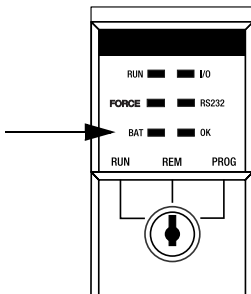

42525

2. If the BAT status indicator is on, see the following step; if the BAT status indicator is off, see [Firmware Revisions](#).
3. Check that the battery or battery module is correctly connected to the controller.
4. If the BAT status indicator remains on, install another battery.
5. If the BAT status indicator remains on after you complete the previous step, contact your Rockwell Automation representative or local distributor.

Checking the OK Status Indicator

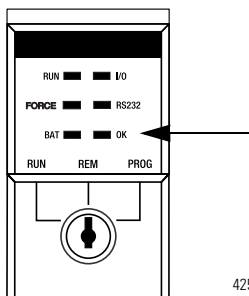

42525

1. Check the color of the OK status indicator.

If	Then	Actions
Solid green	The controller is OK and its firmware has been updated.	No further actions are required. However, the revision of firmware must be compatible with your version of RSLogix 5000 software.
Flashing red	The controller is OK but it requires a firmware update.	Go to Firmware Revisions .
Solid red	The memory board of the controller may not be compatible with the revision of firmware.	Go to the next step.

2. Determine if this is a ControlLogix5555 controller.

If	Then
No	The controller is not operational. Contact your Rockwell Automation representative or local distributor.
Yes	Go to the next step.

- Determine if the memory board has been replaced with a memory board with a different catalog number.

For example, did you replace a 1756-M13 memory board with a 1756-M23 memory board?

If	Then
No	The controller is not operational. Contact your Rockwell Automation representative or local distributor.
Yes	Go to the next step.

- Reinstall the previous memory board.
- Update the firmware of the controller to a revision that is compatible with the memory board that you intend to install.

See [Firmware Revisions](#).

- Install the new memory board.
- Determine the color of the OK status indicator.

If	Then
Solid green	No further actions are required. However, the revision of firmware must be compatible with your version of RSLogix 5000 software.
Solid red	The controller is not operational. Contact your Rockwell Automation representative or local distributor.

Update the Controller

IMPORTANT

RSLogix 5000 software, version 10.0 or later, lets you update the firmware of a controller as part of the download sequence. To update the controller, download your project and follow the prompts of the software.

1. Connect the controller or chassis to the same network as your workstation.
2. Start ControlFLASH software.
3. Click Next.
4. Select the catalog number of the controller, and click Next.
5. Expand the network until you see the controller.

IMPORTANT

If the required network is not shown, first configure a driver for the network in RSLinx software.

To expand a network one level, do one of the following:

- Double-click the network.
- Select the network and press the → key.
- Click the + sign.

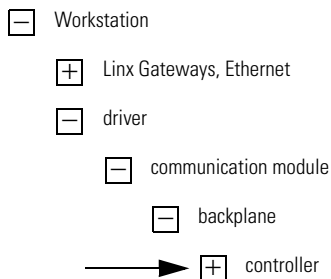

6. Select the controller, and click OK.

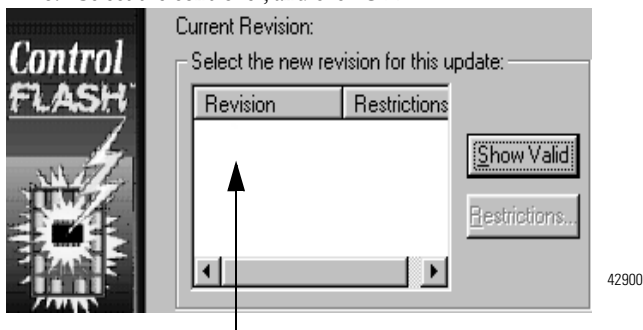

7. Select the revision level to which you want to update the controller and click Next.

IMPORTANT

If the Revision list is empty, download a new upgrade kit. Some older upgrade kits do not work with new controllers.

For more information, refer to the ControlFlash Firmware Upgrade Kit Quick Start, publication [1756-QS105](#).

8. To start the update of the controller, click Finish and then click Yes.

After the controller is updated, the status box displays Update complete.

9. Click OK.
10. To close ControlFLASH software, click Cancel and OK.

Connecting a Serial Cable

WARNING



If you connect or disconnect the serial cable with power applied to this module or the serial device on the other end of the cable, an electrical arc can occur. This could cause an explosion in hazardous location installations. Make sure that power is removed or the area is nonhazardous before proceeding.

Use the serial port for RS-232 communication.

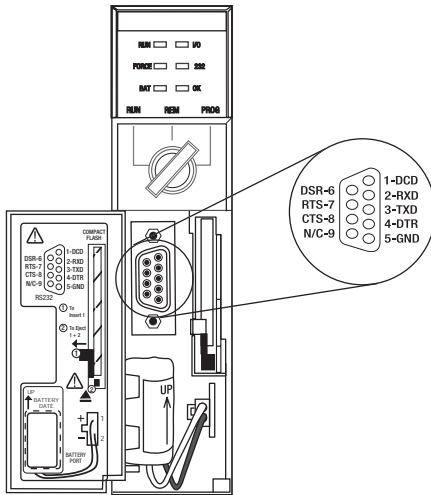

To connect a workstation to the serial port, use one of these cables:

- 1756-CP3 serial cable
- 1747-CP3 cable from the SLC product family. If you use this cable, the controller door may not close.

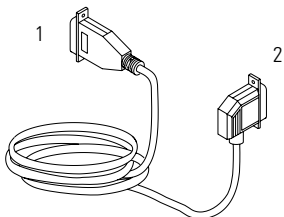

42576

Item	Description
1	Workstation end
2	Controller end

If you make your own serial cable, limit the length to 15.2 m (50 ft), wire the connectors as follows, and attach the shield to both connectors.

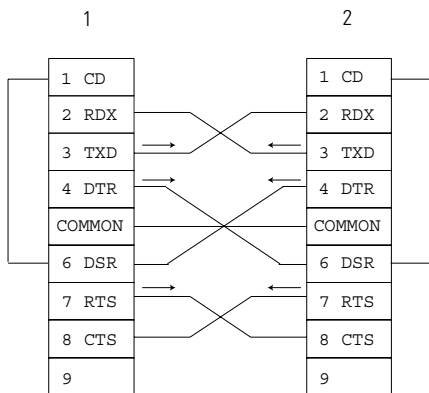

Item	Description
1	Workstation
2	Controller

42231

Interpreting the Status Indicators

The following table describes the status indicators.

Indicator	Status	Description
RUN	Off	The controller is in Program or Test mode. See Choosing the Operating Mode of the Controllers .
	Solid green	The controller is in Run mode. See Choosing the Operating Mode of the Controllers .
I/O	Off	<ul style="list-style-type: none"> • If no devices are in the I/O configuration of the controller, add the required devices to the I/O configuration of the controller. • If the controller does not contain a project (controller memory is empty), download the project to the controller.
	Solid green	The controller is communicating with all the devices in its I/O configuration
	Flashing green	One or more devices in the I/O configuration of the controller are not responding. Go online with RSLogix 5000 software and check the I/O configuration of the controller.
	Flashing red	The chassis is bad. Replace the chassis.
FORCE	Off	<ul style="list-style-type: none"> • No tags contain I/O force values. • I/O forces are inactive (disabled).
	Solid amber	<ul style="list-style-type: none"> • I/O forces are active (enabled). • I/O force values may or may not exist. • Use caution if you install (add) a force. If you install (add) a force, it immediately takes effect.
	Flashing amber	<p>One or more input or output addresses have been forced to an On or Off state, but the forces have not been enabled.</p> <p>Use caution if you enable I/O forces. If you enable I/O forces, all existing I/O forces also take effect.</p>

Indicator	Status	Description
RS232	Off	There is no activity.
	Solid green	Data is being received or transmitted.
BAT	Off	For a Series A controller, the controller does not show this indication.
	Solid green	For a Series B controller, during power-down, the controller is saving the project to its internal nonvolatile memory. If the BAT status indicator is solid red before you turn off the power, the BAT status indicator remains solid red even during the save.
	Solid red	If the battery is not installed, install a battery. If the battery is 95% or more discharged, replace the battery.
OK	Off	No power is applied. When ready, turn on power to the controller.
	Flashing red	If a new controller (just out of the box), the controller requires a firmware update. See Update the Controller . If the controller is not a new controller (previously in operation), a major fault occurred. See Clear a Major Fault .
	Solid red	The controller detected a nonrecoverable fault, so it cleared the project from memory. See Clear a Nonrecoverable Fault .
	Solid green	The controller is ok.
	Flashing green	The controller is storing or loading a project to or from nonvolatile memory. If the controller has a CompactFlash card, leave the card in the controller until the OK status indicator turns solid green.

Clear a Major Fault

1. Go online with RSLogix 5000 software and get the fault code.
2. Determine what to do next.

Fault Type	Fault Code	Action
1	60	A. Clear the fault. B. Download the project to the controller. C. Return the controller to the Run/Remote Run mode. Follow these steps if the problem persists: A. Before you cycle power to the controller, record the state of the OK and RS232 status indicators. B. Contact Rockwell Automation support.
1	61	A. To get diagnostic information about the fault, see Knowledgebase document A92558072. To get the document, see the back of this publication. B. Clear the fault. C. Download the project to the controller. D. Return the controller to the Run/Remote Run mode.
None of the above	None of the above	A. Clear the fault. B. Correct the reason for the fault. C. Return the controller to the Run/Remote Run mode.

To use the keyswitch of the controller to clear a major fault, turn the keyswitch in the following sequence:

1. PROG.
2. RUN.
3. PROG.

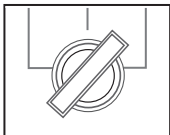

Clear a Nonrecoverable Fault

1. Cycle power to the chassis.
2. Determine what to do next:

If the OK status indicator is	Then
Solid green	A. Download the project to the controller. B. Return the controller to the Run/Remote Run mode.
Flashing red	A. Go online with RSLogix 5000 software and clear the major fault. B. Download the project to the controller. C. Return the controller to the Run/Remote Run mode.
Solid red	Contact your Rockwell Automation representative or local distributor.

Follow these steps if the problem persists.

1. Before you cycle power to the controller, record the state of the OK and RS232 status indicators.
2. Contact Rockwell Automation support.
See the back of this publication.

Choosing the Operating Mode of the Controllers

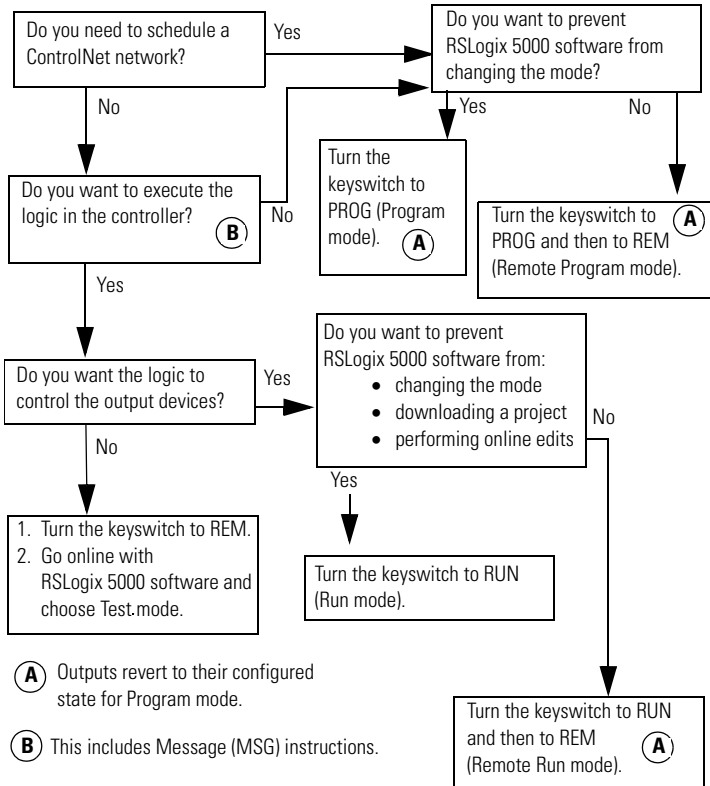

IMPORTANT

- All modes send and receive data in response to a message from another controller.
- All modes produce and consume tags.

Specifications

Specifications - ControlLogix Controllers

Cat. No.	Memory		Non-volatile Memory	Backplane Current		Power Dissipation	Thermal Dissipation	Weight, approx.
	Data and Logic ⁽¹⁾	Yes ⁽²⁾		@ 5.1V DC	@ 24V DC			
1756-L55M22	750 KB	208 KB	Yes	1.23 A	0.014 A	5.6 W	19.1 BTU/hr	0.35 kg (12.5 oz)
1756-L55M23	1.5 MB							0.35 kg (12.5 oz)
1756-L55M24	3.5 MB			1.25 A	5.7 W	19.4 BTU/hr	0.36 kg (12.8 oz)	
1756-L61/A	2 MB	478 KB	Yes ⁽³⁾	1.20 A	14 mA	3.5 W	11.9 BTU/hr	0.32 kg (11.3 oz)
1756-L62/A	4 MB							
1756-L63/A	8 MB							
1756-L61/B	2 MB							
1756-L62/B	4 MB							
1756-L63/B	8 MB							
1756-L64/B	16 MB							
1756-L65/B	32MB							0.35 kg (12.4 oz)

⁽¹⁾ Data and logic memory stores: tags other than I/O, produced, or consumed tags; logic routines; and communication with OPC/DDE tags that use RSLinx software (also uses I/O memory).

⁽²⁾ I/O memory stores: I/O tags, produced tags, consumed tags, communication via Message (MSG) instructions, communication with workstations, and communication with OPC/DDE tags that use RSLinx software (also uses data and logic memory).

⁽³⁾ Requires a 1784-CF64 Industrial CompactFlash card.

ControlLogix Controller Common Specifications - 1756-L1, 1756-L1M1, 1756-L1M2, 1756-L1M3, 1756-L55, 1756-L55M12, 1756-L55M13, 1756-L55M14, 1756-L55M16, 1756-L55M22, 1756-L55M23, 1756-L55M24, 1756-L61, 1756-L62, 1756-L63, 1756-L64, and 1756-L65

Attribute	Value
Temperature, operating	IEC 60068-2-1 (Test Ad, Operating Cold), IEC 60068-2-2 (Test Bd, Operating Dry Heat), IEC 60068-2-14 (Test Nb, Operating Thermal Shock): <ul style="list-style-type: none"> 0 ... 60 °C (32...140 °F)
Temperature, storage	IEC 60068-2-1 (Test Ab, Unpackaged Nonoperating Cold), IEC 60068-2-2 (Test Bb, Unpackaged Nonoperating Dry Heat), IEC 60068-2-14 (Test Na, Unpackaged Nonoperating Thermal Shock): <ul style="list-style-type: none"> -40... 85 °C (-40...185 °F)
Relative humidity	IEC 60068-2-30 (Test Db, Unpackaged Damp Heat): <ul style="list-style-type: none"> 5...95% noncondensing
Vibration	IEC60068-2-6 (Test Fc, Operating): <ul style="list-style-type: none"> 2 g @ 10...500 Hz
Shock, operating	IEC60068-2-27 (Test Ea, Unpackaged Shock): <ul style="list-style-type: none"> 30 g
Shock, nonoperating	IEC60068-2-27 (Test Ea, Unpackaged Shock): <ul style="list-style-type: none"> 50 g
Emissions	CISPR 11: <ul style="list-style-type: none"> Group 1, Class A
ESD immunity	IEC 61000-4-2: <ul style="list-style-type: none"> 6 kV contact discharges 8 kV air discharges
Radiated RF immunity	IEC 61000-4-3: <ul style="list-style-type: none"> 10V/M with 1 kHz sine-wave 80% AM from 80...2000 MHz 10V/M with 200 Hz 50% Pulse 100% AM at 900 Mhz 10V/M with 200 Hz 50% Pulse 100% AM at 1890 Mhz 1V/m with 1 kHz line-wave 80% AM from 2.0...2.7 GHz
EFT/B immunity	IEC 61000-4-4: <ul style="list-style-type: none"> ±4 kV at 5 kHz on communications ports
Surge transient immunity	IEC 61000-4-5: <ul style="list-style-type: none"> ±2 kV line earth (CM) on communications ports

ControlLogix Controller Common Specifications - 1756-L1, 1756-L1M1, 1756-L1M2, 1756-L1M3, 1756-L55, 1756-L55M12, 1756-L55M13, 1756-L55M14, 1756-L55M16, 1756-L55M22, 1756-L55M23, 1756-L55M24, 1756-L61, 1756-L62, 1756-L63, 1756-L64, and 1756-L65

Attribute	Value
Conducted RF immunity	IEC 61000-4-6: <ul style="list-style-type: none"> 10V rms with 1 kHz sine-wave 80% AM from 150 kHz...80 MHz
Enclosure type rating	None, open style
Isolation voltage	30V (continuous), Basic Insulation Type, RS232 to system <ul style="list-style-type: none"> Controllers type tested to withstand 707V DC for 60 s
Wiring category ⁽¹⁾	2 - on communications ports
Programming cable	1756-CP3 or 1747-CP3 serial cable
North American temperature code	T4A
IEC temperature code	T4
Intrinsically safe	No
Replacement battery	1756-L1, 1756-L1M1, 1756-L1M2, 1756-L1M3: 1756-BA1 (0.59 g lithium) 1756-L55, 1756-L55M12, 1756-L55M13, 1756-L55M14, 1756-L55M16, 1756-L55M22, 1756-L55M23, 1756-L55M24: 1756-BA1 (0.59 g lithium) 1756-L61/A, 1756-L62/A, 1756-L63/A: 1756-BA1 (0.59 g lithium) 1756-L61/B, 1756-L62/B, 1756-L63/B, 1756-L64/B, 1756-L65/B: 1756-BA2(0.50 g lithium) 1756-BATM battery module: 1756-BATA (10 g lithium)

⁽¹⁾ Use this Conductor Category information for planning conductor routing. Refer to Industrial Automation Wiring and Grounding Guidelines, publication [1770-4.1](#).

ControlLogix Memory Board Specifications - 1756-M1, 1756-M2, 1756-M3, 1756-M12, 1756-M13, 1756-M14, 1756-M16, 1756-M22, 1756-M23, and 1756-M24

Attribute	Value
Temperature, operating	EC 60068-2-1 (Test Ad, Operating Cold), IEC 60068-2-2 (Test Bd, Operating Dry Heat), IEC 60068-2-14 (Test Nb, Operating Thermal Shock): <ul style="list-style-type: none"> 0 ... 60 °C (32...140 °F)
Temperature, storage	IEC 60068-2-1 (Test Ab, Unpackaged Nonoperating Cold), IEC 60068-2-2 (Test Bb, Unpackaged Nonoperating Dry Heat), IEC 60068-2-14 (Test Na, Unpackaged Nonoperating Thermal Shock): -40... 85 °C (-40...185 °F)
Relative humidity	EC 60068-2-30 (Test Db, Unpackaged Damp Heat): <ul style="list-style-type: none"> 5...95% noncondensing
Vibration	IEC 60068-2-6 (Test Fc, Operating): <ul style="list-style-type: none"> 2 g @ 10...500 Hz
Shock, operating	IEC60068-2-27 (Test Ea, Unpackaged Shock): <ul style="list-style-type: none"> 30 g
Shock, nonoperating	IEC60068-2-27 (Test Ea, Unpackaged Shock): <ul style="list-style-type: none"> 50 g
Emissions	CISPR 11: <ul style="list-style-type: none"> Group 1, Class A
ESD immunity	IEC 61000-4-2: <ul style="list-style-type: none"> 6 kV indirect contact discharge 8 kV air discharge
Radiated RF immunity	IEC 61000-4-3: <ul style="list-style-type: none"> 10V/m with 1 kHz sine-wave 80% AM from 80...2000 MHz 10V/m with 200 Hz 50% Pulse 100% AM at 900 MHz 10V/m with 200 Hz 50% Pulse 100% AM at 1890 MHz 1V/m with 1 kHz line-wave 80% AM from 2.0...2.7 GHz
Enclosure type rating	None, open style
North American temperature code	T4A
IEC temperature code	T4
Intrinsically safe	No

Industrial CompactFlash Card Specifications - Industrial CompactFlash Card - 1784-CF64, 1784-CF128

Attribute	Value
User available memory	64 MB, 128 MB
Nonvolatile memory	Yes
Weight, approx.	14.2 g (0.5 oz)
Temperature, operating	IEC 60068-2-1 (Test Ad, Operating Cold), IEC 60068-2-2 (Test Bd, Operating Dry Heat), IEC 60068-2-14 (Test Nb, Operating Thermal Shock): <ul style="list-style-type: none"> 0...60 °C (32...140 °F)
Temperature, storage	IEC 60068-2-1 (Test Ab, Unpackaged Nonoperating Cold), IEC 60068-2-2 (Test Bb, Unpackaged Nonoperating Dry Heat), IEC 60068-2-14 (Test Na, Unpackaged Nonoperating Thermal Shock): <ul style="list-style-type: none"> -40...85 °C (-40...185 °F)
Relative humidity	IEC 60068-2-30 (Test Db, Unpackaged Damp Heat): <ul style="list-style-type: none"> 5...95% noncondensing
Vibration	IEC 60068-2-6 (Test Fc, Operating): <ul style="list-style-type: none"> 2 g @ 10...500 Hz
Shock, operating	IEC 60068-2-27 (Test Ea, Unpackaged Shock): <ul style="list-style-type: none"> 30 g
Shock, nonoperating	IEC 60068-2-27 (Test Ea, Unpackaged Shock): <ul style="list-style-type: none"> 50 g
Emissions	CISPR 11: <ul style="list-style-type: none"> Group 1, Class A
ESD immunity	IEC 61000-4-2: <ul style="list-style-type: none"> 4 kV contact discharges 8 kV air discharges
Radiated RF immunity	IEC 61000-4-3: <ul style="list-style-type: none"> 10V/m with 1 kHz sine-wave 80% AM from 80...2000 MHz 10V/m with 200 Hz 50% Pulse 100% AM at 900 Mhz 10V/m with 200 Hz 50% Pulse 100% AM at 1890 Mhz 1V/m with 1 kHz line-wave 80% AM from 2.0...2.7 GHz

Certifications - ControlLogix Controller Certifications⁽¹⁾

Cat. No.	Certification	Description
1756-L1, 1756-L55	UL	UL Listed Industrial Control Equipment. See UL File E65584.
	CSA	CSA Certified Process Control Equipment. See CSA File LR54689C. CSA Certified Process Control Equipment for Class I, Division 2 Group A,B,C,D Hazardous Locations. See CSA File LR69960C.
	CE	European Union 2004/108/IEC EMC Directive, compliant with: <ul style="list-style-type: none"> • EN 61326-1; Meas./Control/Lab., Industrial Requirements • EN 61000-6-2; Industrial Immunity • EN 61000-6-4; Industrial Emissions • EN 61131-2; Programmable Controllers (Clause 8, Zone A & B)
	C-Tick	Australian Radiocommunications Act, compliant with: AS/NZS CISPR 11; Industrial Emissions
	EEx	European Union 94/9/EC ATEX Directive, compliant with: EN 60079-15; Potentially Explosive Atmospheres, Protection 'n' (Zone 2)

Certifications - ControlLogix Controller Certifications⁽¹⁾

Cat. No.	Certification	Description
1756-L61, 1756-L62, 1756-L63, 1756-L64, 1756-L65	c-UL-us	UL Listed Industrial Control Equipment, certified for US and Canada. See UL File E65584.
	c-UL-us	UL Listed for Class I, Division 2 Group A,B,C,D Hazardous Locations, certified for U.S. and Canada. See UL File E194810.
	CSA	CSA Certified Process Control Equipment. See CSA File LR54689C. CSA Certified Process Control Equipment for Class I, Division 2 Group A,B,C,D Hazardous Locations. See CSA File LR69960C.
	FM	FM Approved Equipment for use in Class I Division 2 Group A,B,C,D Hazardous Locations
	CE	European Union 2004/108/IEC EMC Directive, compliant with: <ul style="list-style-type: none"> • EN 61326-1; Meas./Control/Lab., Industrial Requirements • EN 61000-6-2; Industrial Immunity • EN 61000-6-4; Industrial Emissions • EN 61131-2; Programmable Controllers (Clause 8, Zone A & B)
	C-Tick	Australian Radiocommunications Act, compliant with: AS/NZS CISPR 11; Industrial Emissions
EEx	European Union 94/9/EC ATEX Directive, compliant with: EN 60079-15; Potentially Explosive Atmospheres, Protection "n" (Zone 2)	

⁽¹⁾ When the product is marked. See the Product Certification link at <http://www.ab.com> for Declarations of Conformity, Certificates, and other certification details.

Certifications - ControlLogix Memory Board⁽¹⁾

Cat. No.	Certification	Description
1756-M1, 1756-M2 1756-M3	UR	UL Recognized Component Industrial Control Equipment. See UL File E65584.
1756-M12 1756-M13 1756-M14	CSA	CSA Certified Process Control Equipment. See CSA File LR54689C. CSA Certified Process Control Equipment for Class I, Division 2 Group A,B,C,D Hazardous Locations. See CSA File LR69960C.
1756-M16 1756-M22 1756-M23 1756-M24	CE	European Union 2004/108/IEC EMC Directive, compliant with: <ul style="list-style-type: none"> • EN 61326-1; Meas./Control/Lab., Industrial Requirements • EN 61000-6-2; Industrial Immunity • EN 61000-6-4; Industrial Emissions • EN 61131-2; Programmable Controllers (Clause 8, Zone A & B)
	C-Tick	Australian Radiocommunications Act, compliant with: AS/NZS CISPR 11; Industrial Emissions
	EEx	European Union 94/9/EC ATEX Directive, compliant with: EN 60079-15; Potentially Explosive Atmospheres, Protection "n" (Zone 2)

⁽¹⁾ When product is marked. See the Product Certification link at <http://www.ab.com> for Declarations of Conformity, Certificates, and other certification details.

Certifications - 1784-CF64 and 1784-CF128 Industrial CompactFlash Card⁽¹⁾

Certification	Description
CE	European Union 2004/108/IEC EMC Directive, compliant with: <ul style="list-style-type: none"> • EN 61326-1; Meas./Control/Lab., Industrial Requirements • EN 61000-6-2; Industrial Immunity • EN 61000-6-4; Industrial Emissions • EN 61131-2; Programmable Controllers (Clause 8, Zone A & B)
C-Tick	Australian Radiocommunications Act, compliant with: AS/NZS CISPR 11; Industrial Emissions

⁽¹⁾ When product is marked. See the Product Certification link at <http://www.ab.com> for Declarations of Conformity, Certificates, and other certification details.

Additional Resources

These documents contain additional information concerning related Rockwell Automation <http://www.ab.com> products.

Resource	Description
ControlFLASH Firmware Upgrade Kit Quick Start, publication 1756-QS105	Contains information on how to upgrade and manage module firmware.
ControlLogix Controllers User Manual, publication 1756-UM001	Contains information on how to install, configure, program, and operate a ControlLogix system.
ControlLogix Redundancy System User Manual, publication 1756-UM523	Contains information about ControlLogix redundancy systems and media.
ControlLogix Chassis-Series B Installation Instructions, publication 1756-IN080	Contains information on how to install a ControlLogix chassis.
ControlLogix Power Supplies Installation Instructions, publication 1756-IN596	Contains information on how to install the 1756-PA75 and 1756-PB75 ControlLogix power supplies.
Industrial Automation Wiring and Grounding Guidelines, publication 1770-4.1	Provides general guidelines for installing a Rockwell Automation industrial system.
Product Certifications website, http://ab.com	Provides declarations of conformity, certificates, and other certification details.

You can view or download publications at <http://literature.rockwellautomation.com>. To order paper copies of technical documentation, contact your local Rockwell Automation distributor or sales representative.

Notes:

Notes:

Rockwell Automation Support

Rockwell Automation provides technical information on the Web to assist you in using its products. At <http://support.rockwellautomation.com>, you can find technical manuals, a knowledge base of FAQs, technical and application notes, sample code and links to software service packs, and a MySupport feature that you can customize to make the best use of these tools.

For an additional level of technical phone support for installation, configuration, and troubleshooting, we offer TechConnect support programs. For more information, contact your local distributor or Rockwell Automation representative, or visit <http://support.rockwellautomation.com>.

Installation Assistance

If you experience a problem within the first 24 hours of installation, please review the information that's contained in this manual. You can also contact a special Customer Support number for initial help in getting your product up and running.

United States	1.440.646.3434 Monday – Friday, 8 a.m. – 5 p.m. EST
Outside United States	Please contact your local Rockwell Automation representative for any technical support issues.

New Product Satisfaction Return

Rockwell Automation tests all of its products to ensure that they are fully operational when shipped from the manufacturing facility. However, if your product is not functioning and needs to be returned, follow these procedures.

United States	Contact your distributor. You must provide a Customer Support case number (call the phone number above to obtain one) to your distributor in order to complete the return process.
Outside United States	Please contact your local Rockwell Automation representative for the return procedure.

Allen-Bradley, ControlLogix, Rockwell Automation, RSLogix 5000, TechConnect, ControlFlash, and RSLinx are trademarks of Rockwell Automation, Inc.

Trademarks not belonging to Rockwell Automation are property of their respective companies.

www.rockwellautomation.com

Power, Control and Information Solutions Headquarters

Americas: Rockwell Automation, 1201 South Second Street, Milwaukee, WI 53204-2496 USA, Tel: (1) 414.582.2000, Fax: (1) 414.582.4444

Europe/Middle East/Africa: Rockwell Automation, Vorstlaan/Boulevard du Souverain 36, 1170 Brussels, Belgium, Tel: (32) 2 665 0800, Fax: (32) 2 665 0840

Publication 1756-IN101L-EN-P - June 2008

PN-27699

Supersedes Publication 1756-IN101K-EN-P - August 2006

Copyright © 2008 Rockwell Automation, Inc. All rights reserved. Printed in the U.S.A.