



# Universal I/O Chassis

(Cat. No. 1771-A1B, -A2B, -A3B, -A3B1, -A4B Series B)

## Installation Data

### To the Installer

To install an I/O chassis you	See page
prepare for installation . . . . .	1
allow sufficient mounting space . . . . .	2
mount the I/O chassis and ground bus . . . . .	5
ground the chassis . . . . .	6
set the power supply configuration jumper . . . . .	10
set the switches on the backplane assembly . . . . .	10
provide power to the I/O chassis . . . . .	11
install I/O modules . . . . .	12

### Prepare for Installation

Make sure you have these items:

#### I/O-group-label set (cat. no. 1771-XB)

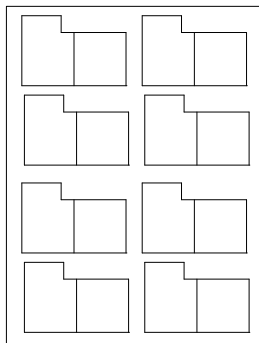

#### Hardware kit (cat. no. 1771-RK)

plastic keying bands (number depends on size of chassis)

- 9 → 1771-A1B
- 18 → 1771-A2B
- 27 → 1771-A3B, 1771-A3B1
- 36 → 1771-A4B

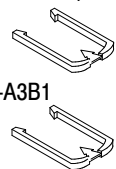

1 star washer



1 cup washer



4 flat washers

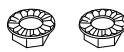

2 #10-32 nuts with captive lock washers

#### Documentation

(if you are installing I/O modules or power supplies)

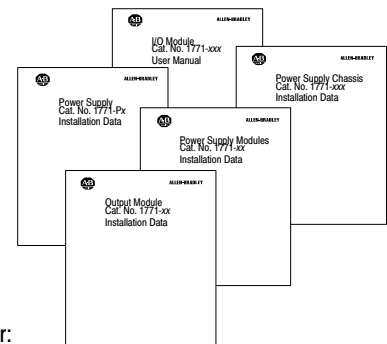

for your:

- programmable controller or I/O adapter module
- external power supply and/or power supply chassis (if you are using external power supplies)
- communication modules and/or I/O modules
- power-supply modules

**Allow Sufficient Mounting Space**

For these mounting dimensions	See page
I/O chassis	3
I/O chassis with external power supply	4

**Important:** Make sure you meet these minimum spacing requirements.

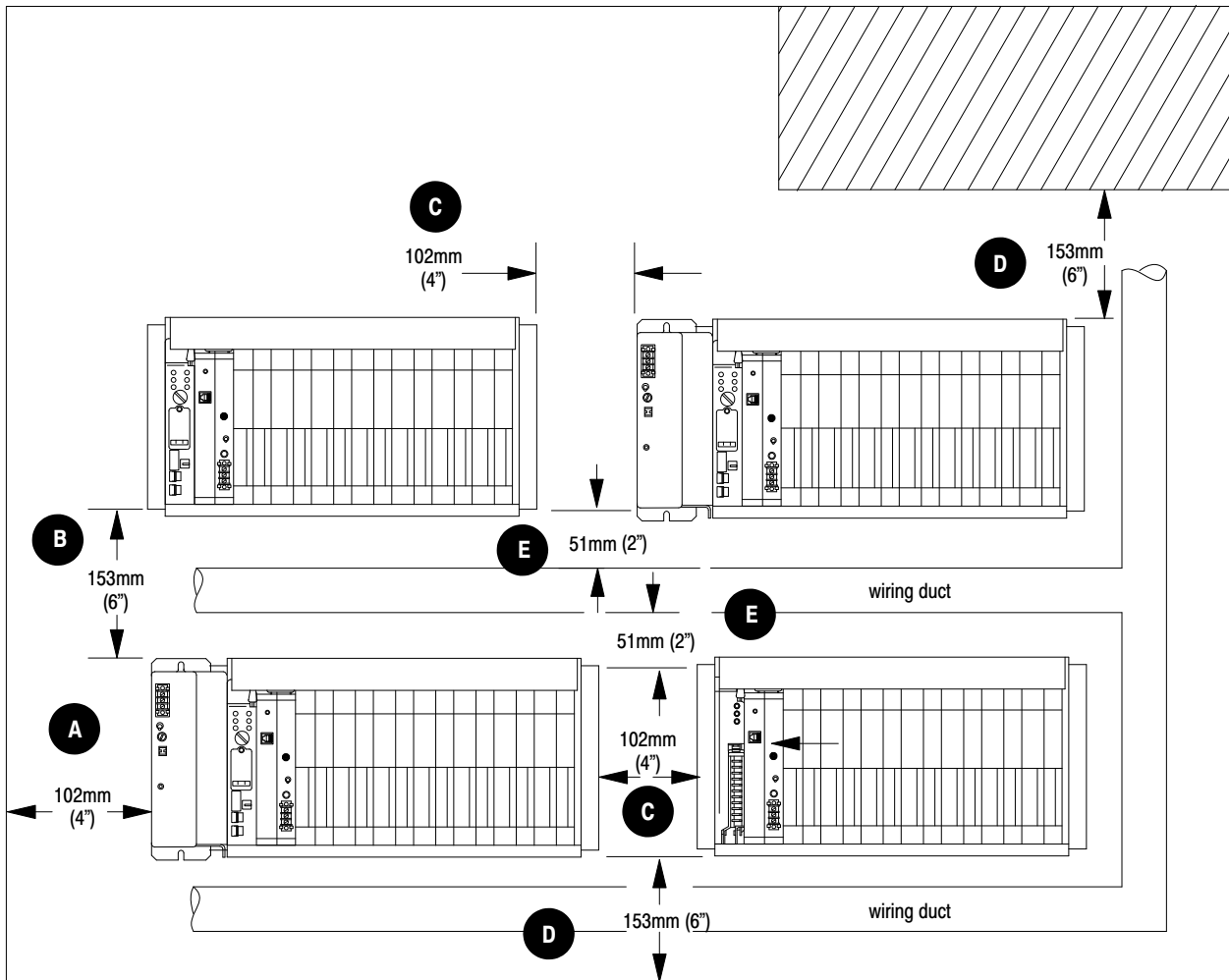

- A** Minimum distance between a major component and the sides of an enclosure is 102mm (4 inches).
- B** Minimum vertical separation between major components is 153mm (6 inches).
- C** Minimum horizontal separation between major components is 102mm (4 inches).
- D** Minimum vertical distance between a major component and the top or bottom of an enclosure is 153mm (6 inches).
- E** Minimum distance between major components and wiring ducts or terminal strips is 51mm (2 inches).

**I/O Chassis Mounting Dimensions**

**1771-A1B**  
**1771-A2B**  
**1771-A3B1**  
**1771-A4B**

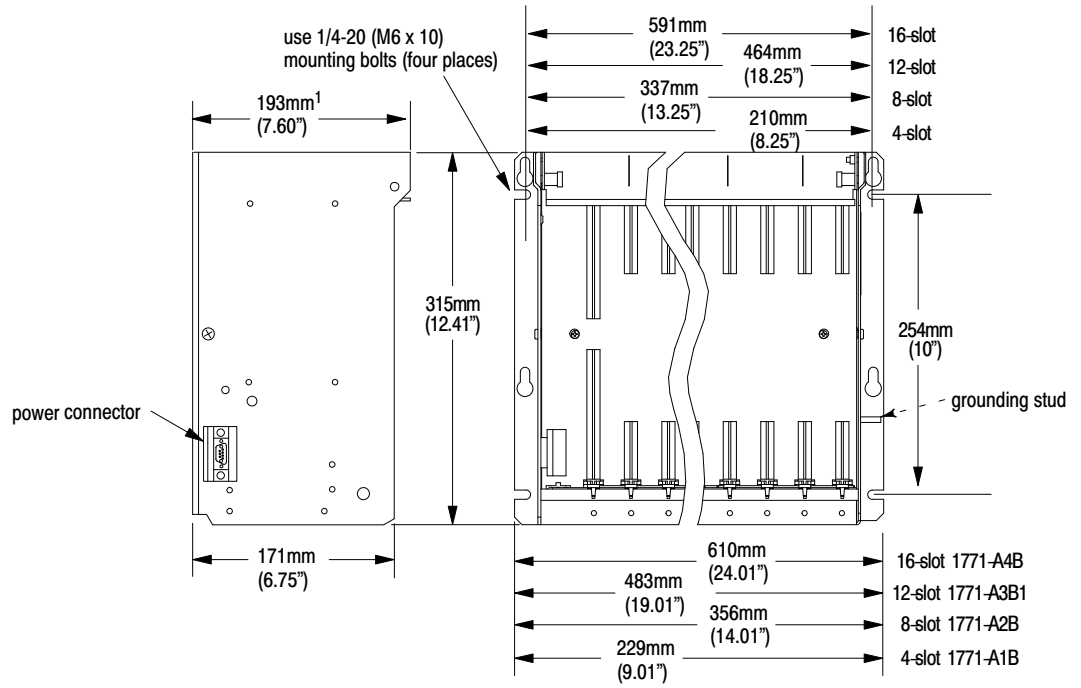

**1771-A3B**

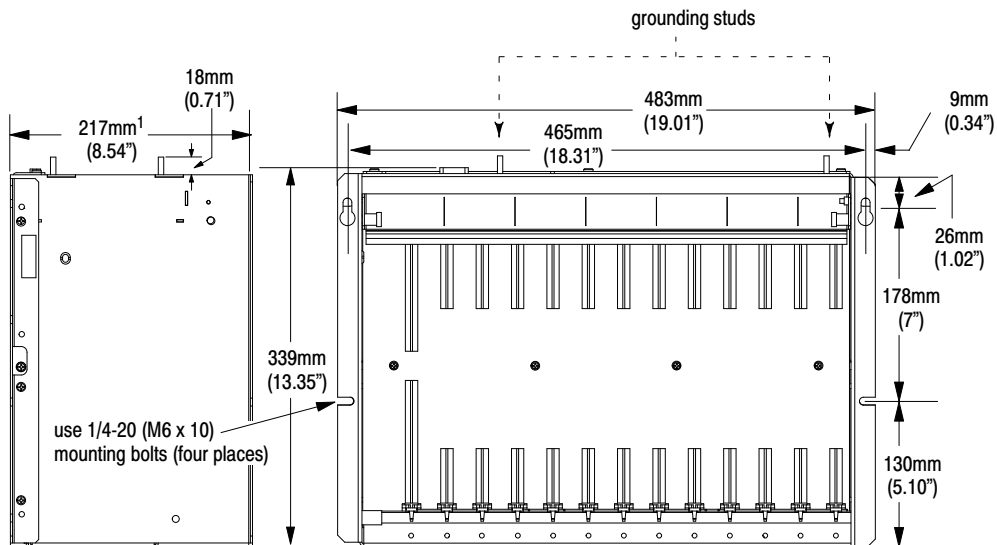

<sup>1</sup>Total maximum depth dimension per installation depends on module wiring and connectors.

**Installation Data**  
**Universal I/O Chassis**  
**1771-A1B, -A2B, -A3B, -A3B1, -A4B Series B**

**I/O Chassis with External Power Supply Mounting Dimensions**

**1771-A1B**  
**1771-A2B**  
**1771-A3B1**  
**1771-A4B**

You can mount 1771-P1, -P2, -P7 and -PS7 power supplies on the left side plate of the I/O chassis, or up to 5 cable-feet from the I/O chassis.

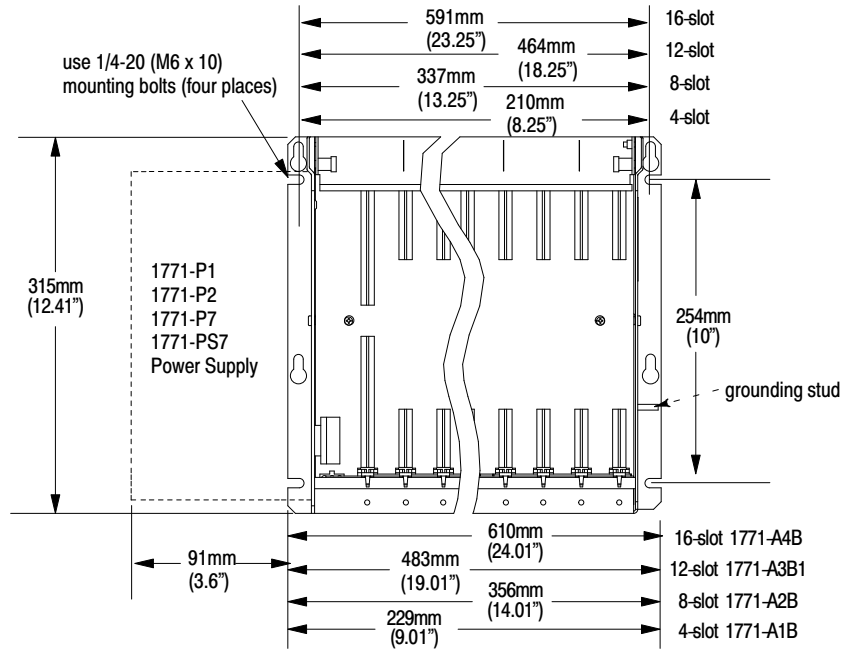

12451-I

**1771-A3B**

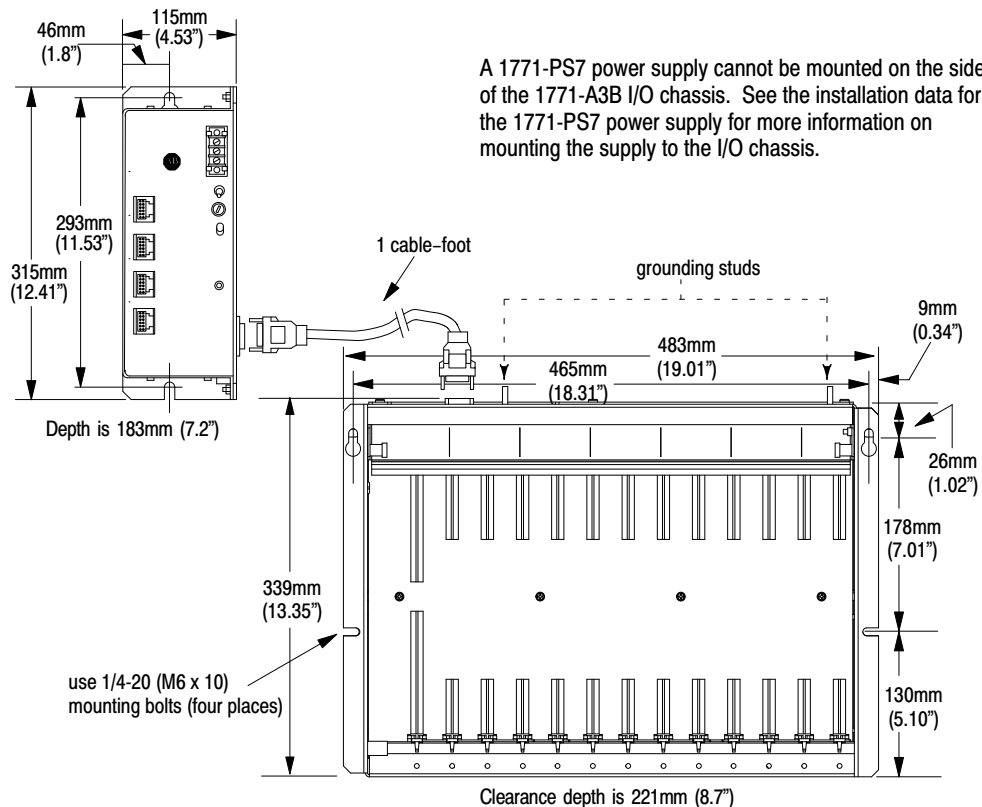

12452-I

## Mount the I/O Chassis and Ground Bus

If you have this I/O chassis	Type of mount
1771-A1B, -A2B, -A3B1, -A4B	panel mount (rear mount)
1771-A3B	19" rack mount (front mount) or panel mount (rear mount)

Each enclosure must contain a central ground bus. The ground bus is the common connection for each chassis within the enclosure and the enclosure itself. Use either bolts or welded studs to mount the I/O chassis and central ground bus. If you are mounting a chassis to the back panel of an enclosure, use 1/4-20 (M6 x 10) mounting bolts.

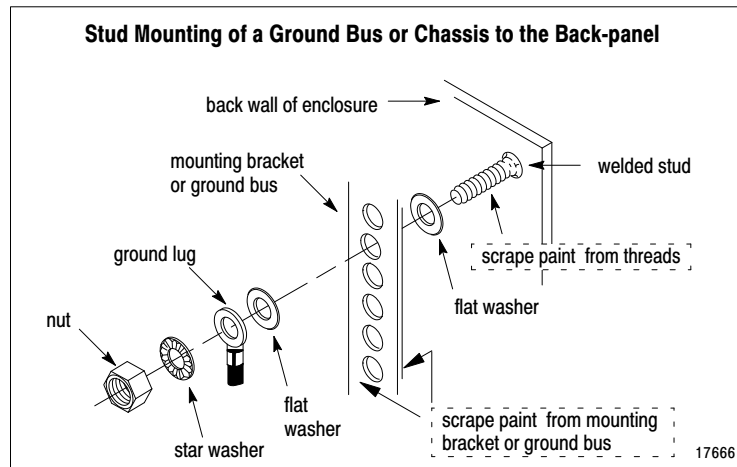
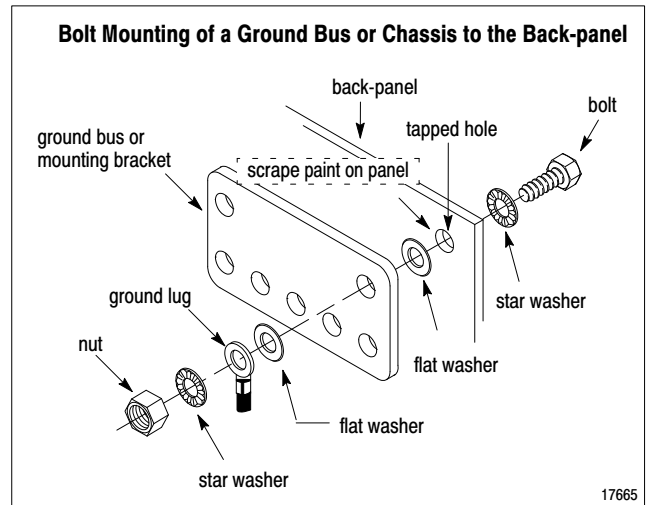
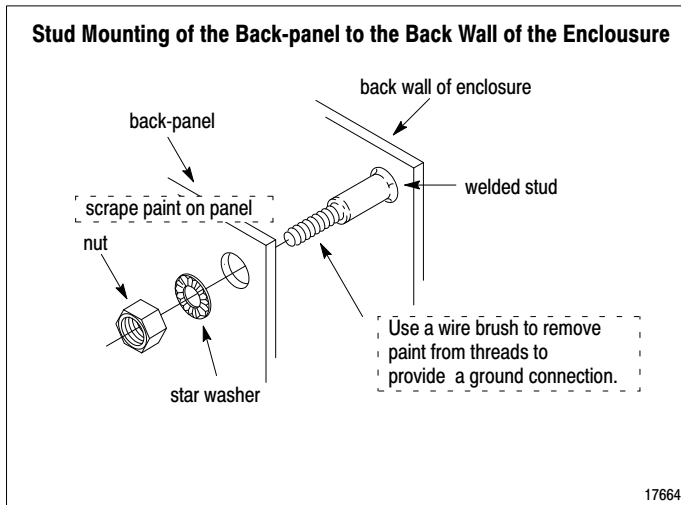

**ATTENTION:** If the mounting brackets of a chassis do not lay flat before the nuts are tightened, use additional washers as shims so that the chassis will not be warped by tightening the nuts. Warping a chassis could damage the backplane and cause poor connections.

## Ground Your I/O Chassis

To properly ground your I/O chassis	See page
verify that your system-design plans are using the correct system grounding configuration . . . . .	6
ground the chassis . . . . .	7
connect equipment grounding conductors . . . . .	8
connect a ground bus to the grounding electrode system . . . . .	9
ground shielded cables . . . . .	9

### Verify Grounding Configuration

#### Remote I/O Systems

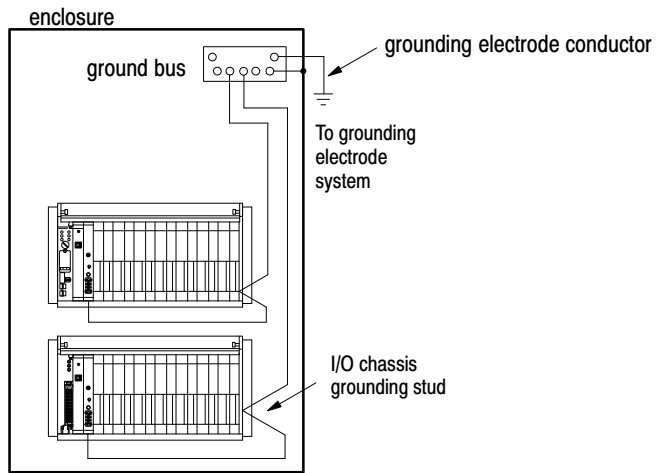

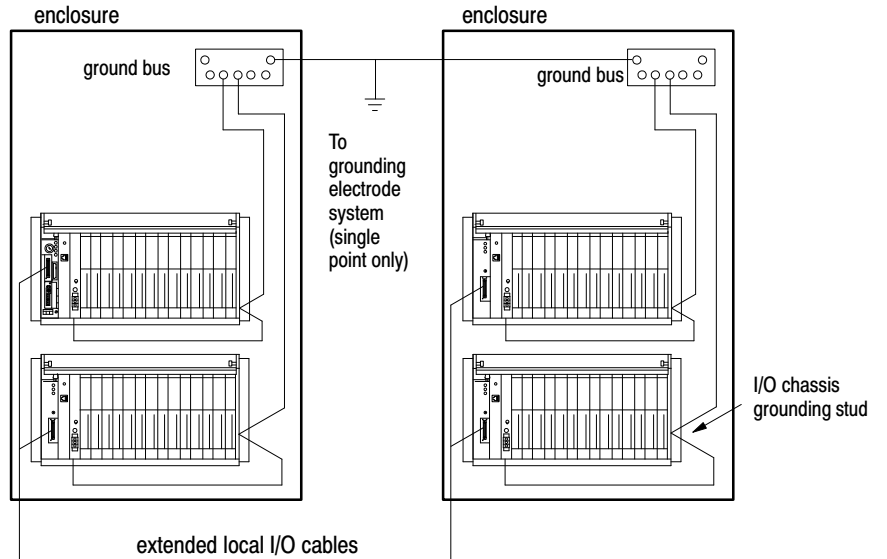

#### Extended-Local I/O Systems



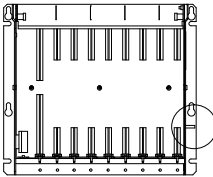
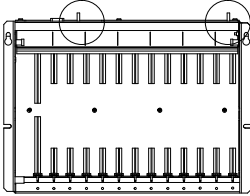

19938

## Ground the Chassis

This I/O chassis	Has grounding stud(s) located
1771-A1B 1771-A2B 1771-A3B1 1771-A4B	
1771-A3B <sup>1</sup>	 <div style="display: inline-block; vertical-align: middle;">  <p><b>ATTENTION:</b> To prevent ground loops from occurring, use only one grounding stud when grounding your equipment.</p> </div>

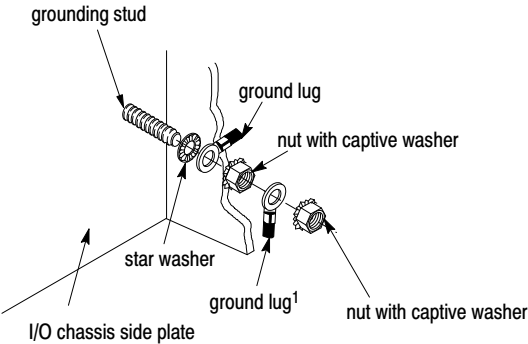
**Important:** Use the following information, along with the installation manual for your programmable controller to ground the I/O chassis and your I/O modules.

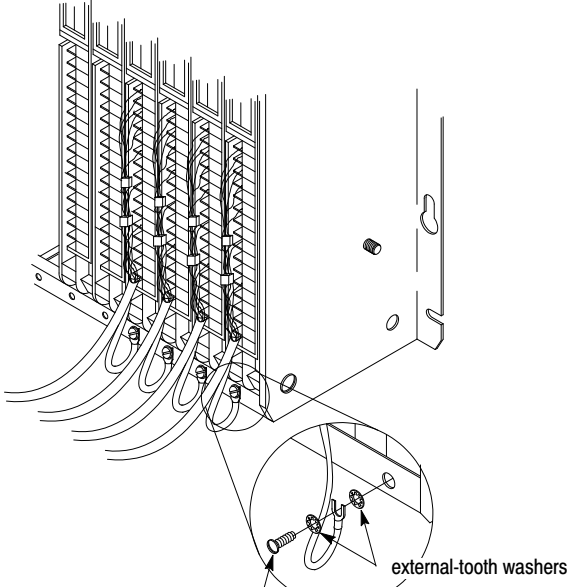
Chassis Ground	Single-point Grounding
<p>When you connect grounding conductors to the I/O chassis grounding stud, place a star washer under the first lug, then place a nut with captive lock washer on top of each ground lug.</p>  <p><sup>1</sup>Use the cup washer if crimp-on lugs are not used.</p>	<div style="display: inline-block; vertical-align: middle;">  <p><b>ATTENTION:</b> Use single-point grounding for extended-local I/O systems. The systems must be grounded properly for proper performance.</p> </div>  <p>#10 thread-forming screw</p>

## Connect Equipment Grounding Conductor

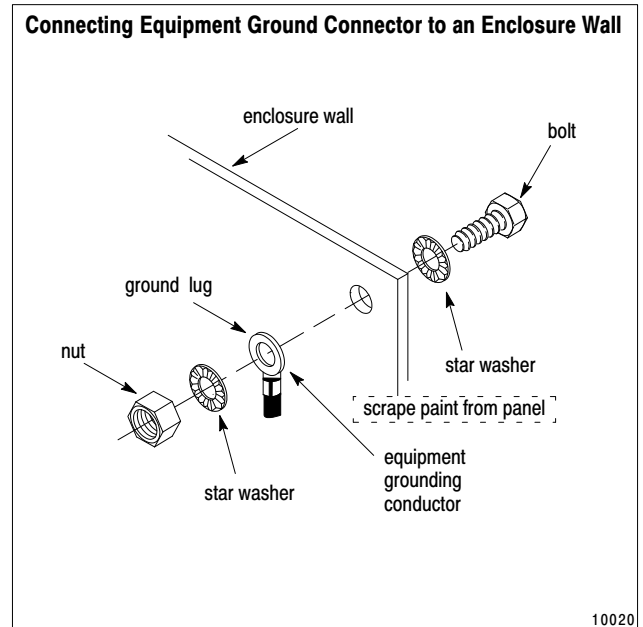
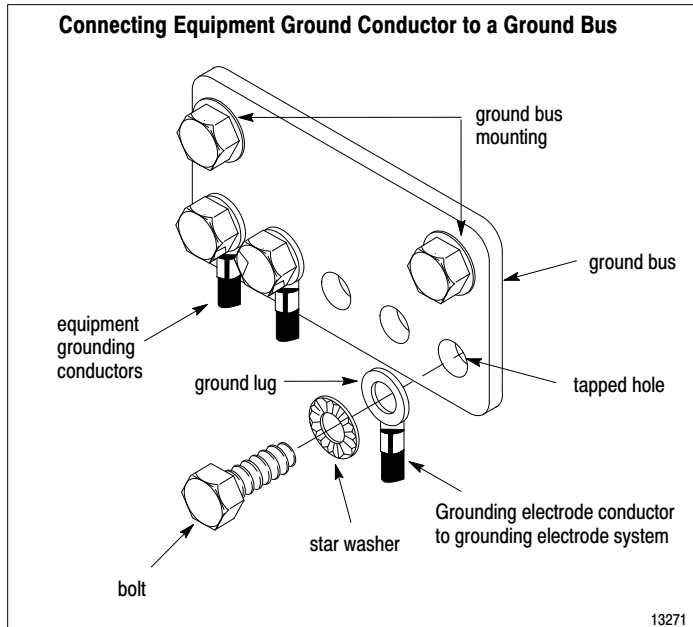

- use 2.54cm (1in.) copper braid or 8 AWG copper wire to connect each chassis, the enclosure and a central ground bus mounted on the back-panel
- use a steel enclosure to guard against electromagnetic interference (EMI)
- make sure the enclosure door viewing window is a laminated screen or a conductive optical substrate (to block EMI)
- install a bonding wire for electrical contact between the door and the enclosure; do not rely on the hinge

**Important:** Do not lay one ground lug directly on top of the other; this type of connection can become loose due to compression of the metal lugs. Place the first lug between a star washer and a nut with a captive star washer. After tightening the nut, place the second lug between the first nut and a second nut with a captive star washer.

Connect an equipment grounding conductor directly from each chassis to an individual bolt on the ground bus.

For chassis with	Connect the equipment grounding conductor using
a ground stud	the grounding stud
no ground stud	a mounting bolt

If the power supply has its own groundable chassis, do not connect the GND terminal of the power supply. However, when you connect power to a power supply without a groundable chassis (such as an ac input power-supply module), you must also use 14 AWG copper wire to connect its GND terminal to the ground stud or mounting bolt connected to the ground bus.



## **Connect Ground Bus to Grounding-Electrode System**

The grounding-electrode system is at earth-ground potential and is the central ground for all electrical equipment and ac power within any facility. Use a grounding-electrode conductor to connect the ground bus to the grounding-electrode system. Use at minimum 8 AWG copper wire for the grounding-electrode conductor to guard against EMI. The National Electrical Code specifies safety requirements for the grounding-electrode conductor.

## **Ground Shielded Cables**

Certain connections require shielded cables to help reduce the effects of electrical noise coupling. Ground each shield at one end only. A shield grounded at both ends forms a ground loop which could cause faulty PLC-5 processor operation.

Ground each shield at the end specified in the appropriate publication for the product.

Avoid breaking shields at junction boxes. Many types of connectors for shielded conductors are available from various manufacturers. If you do break a shield at a junction box:

- connect only category-2 conductors in the junction box
- do not strip the shield back any further than necessary to make a connection
- connect the shields of the two cable segments to ensure continuity along the entire length of the cable



For more information about grounding the chassis, see *Programmable Controller Wiring and Grounding Guidelines* (publication 1770-4.1).

### Set the Power Supply Configuration Jumper

Set the power supply configuration jumper according to the power supply you are using.



**ATTENTION:** If you do not properly configure the power supply configuration jumper, the processor will fail.

If you are using	Set jumper to
a power-supply module or a processor with an integral power supply (1772-LSP, -LWP, -LXP or -LZP)	 "Y" position
a power supply external to the I/O chassis	 "N" position

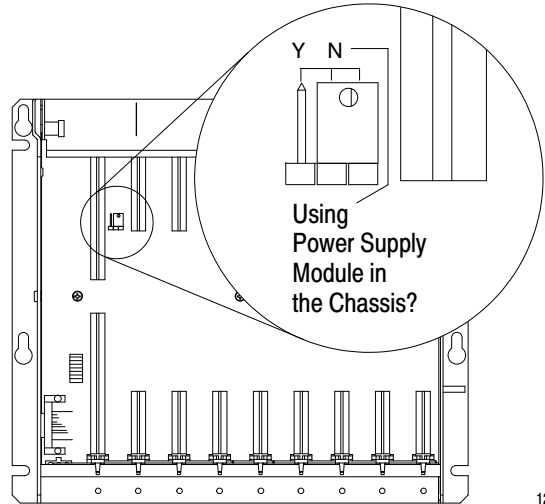

12620-I

**Important:** You cannot power a single I/O chassis with both a power-supply module and an external power supply.

### Set the Switches on the Backplane Assembly

Use the installation manual for your programmable controller or adapter module to set the switches.



**ATTENTION:** If you do not properly configure the backplane switch assembly, various system failures may occur.

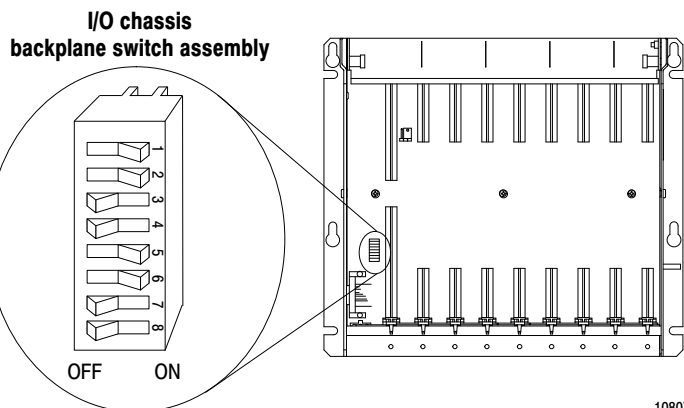

10807-I

## Provide Power to the I/O Chassis

Your I/O chassis can receive power through:

- processors with integral power supplies that provide 2-4A
- power-supply modules that provide 3-8A
- external power supplies that provide 6.5-16A  
*(external power supplies are not designed for parallel operation)*

Power-supply modules are designed for parallel operation. See your power supply installation documentation for possible configurations.

**Important:** The 1772-LSP, -LWP, -LXP, and -LZP processor modules already contain a power supply so you can only parallel one additional power-supply module with these processor modules.



**ATTENTION:** Do not connect an external power supply and a power-supply module to the same I/O chassis; they are incompatible.

If your I/O chassis is receiving power through	Then
an external power supply or a power supply chassis	continue with this section
power-supply modules	go to page <a href="#">12</a>

## Attaching a Power Supply to an I/O Chassis

The I/O chassis has two power connectors. You connect the external power supply or power supply chassis (1771-PSC) to the I/O chassis using these connectors and the appropriate power supply cables.

**Important:** Use the installation data for your power supply or power supply chassis to properly mount it to your I/O chassis.

**Important:** If you mount a power supply to any I/O chassis, place the flat washers provided between each mounting screw and the power supply mounting bracket. If you do not use the flat washers, the mounting screw intrudes into the I/O chassis and interferes with module insertion.

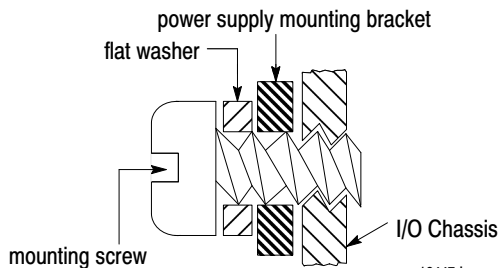

12447-1

This I/O chassis	Has power connectors located
1771-A1B 1771-A2B 1771-A3B1 1771-A4B	
1771-A3B	

## Install Your I/O Modules

The left-most slot of each chassis accepts either a processor module or an I/O adapter module. The other slots in the chassis accept communication modules, I/O modules and power-supply modules.

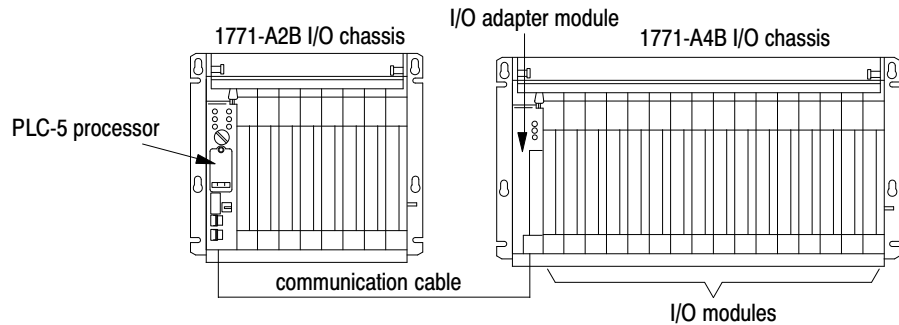

11865

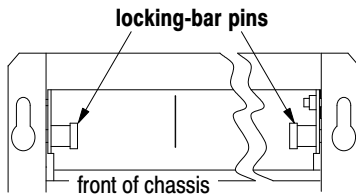

12453-1

To insert a module:

1. Pull the locking-bar pins to release the locking bar and swing it up.
2. Use the installation data/user manual for your module to to:
  - a. position the keying bands in the backplane connectors to correspond to the key slots on the module. This prevents you from inserting the wrong module in this slot.



**ATTENTION:** Observe the following precautions when inserting or removing keys:

- insert or remove keys with your fingers
- make sure that key placement is correct

Incorrect keying or the use of a tool can result in damage to the backplane connector and possible system faults.

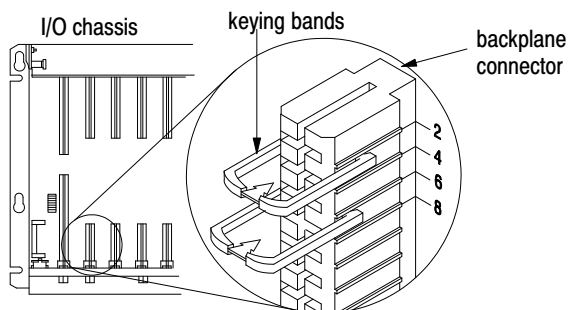

Each I/O module is slotted in two places at the rear edge of the circuit board. These slots are intended to mate with the plastic keys supplied with each chassis.

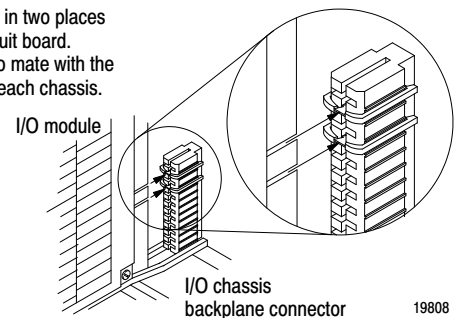

19808

- b. install the module.

**Important:** Firmly press the module into the chassis backplane connector. The chassis locking bar will not close if any modules are not seated properly.

Repeat for each module you install.

- Swing the chassis locking bar down into place to secure the modules. Make sure the locking pins engage.
- Apply the I/O group labels over the scored lines on the I/O chassis locking bar as shown below. On each label, record the I/O rack number, I/O group number and terminal numbering for each module.

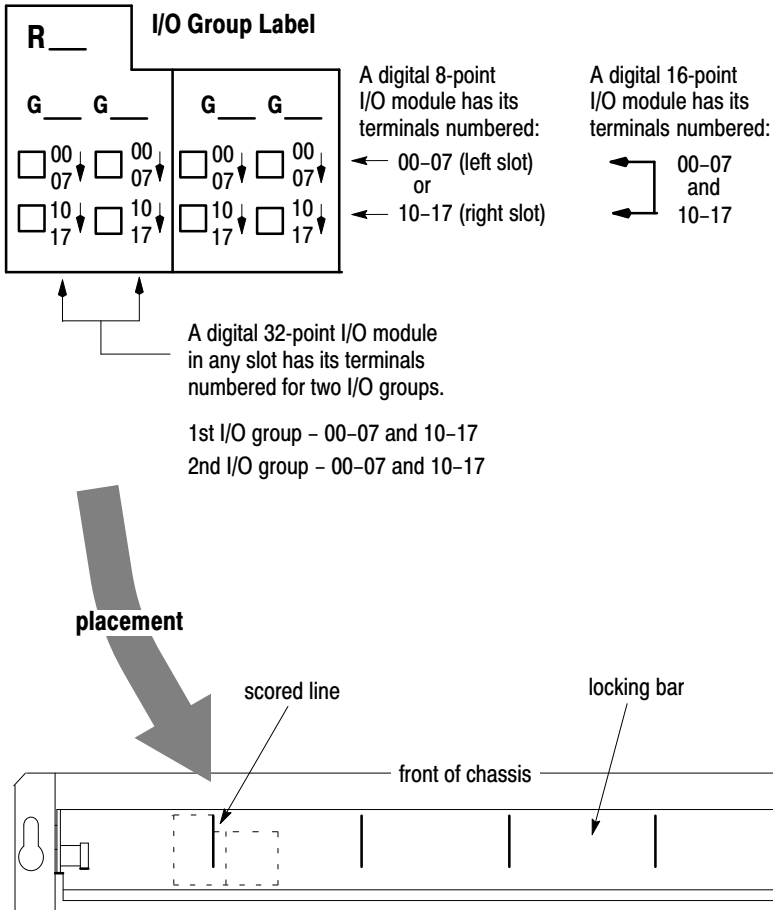

**Examples:**

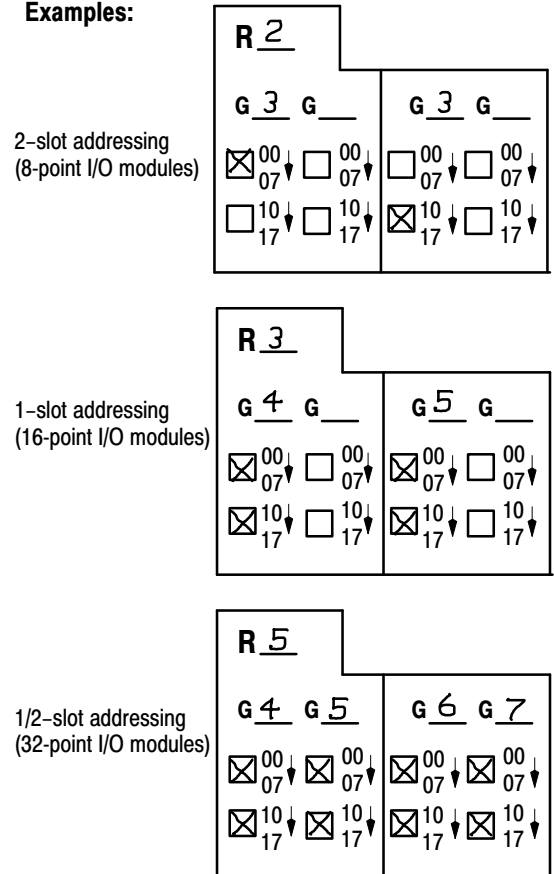

12448-I

- Use your module's installation data to make other wiring connections.
- Apply power to the system and run tests as required.

**Installation Data**  
**Universal I/O Chassis**  
**1771-A1B, -A2B, -A3B, -A3B1, -A4B Series B**

**Specifications**

I/O Chassis Series B (Cat. No.)	Type of Mount	General Dimensions (W x H x D)	Weight (without modules)	I/O Module Slots	Maximum Backplane Current	Compatible Replacement for Chassis	
						Series A	Supersedes
1771-A1B	panel	229 x 315 x 193mm (9.0 x 12.4 x 7.6 inches)	3.6kg (8lbs)	4	16A	1771-A1B	1771-A1
1771-A2B	panel	356 x 315 x 193mm (14.0 x 12.4 x 7.6 inches)	4.5kg (10lbs)	8	16A	1771-A2B	1771-A2
1771-A3B	panel or 19" rack	483 x 339 x 221mm (19.0 x 13.35 x 8.7 inches)	5.9kg (13lbs)	12	24A	1771-A3B	none
1771-A3B1	panel	483 x 315 x 193mm (19.0 x 12.4 x 7.6 inches)	5.9kg (13lbs)	12	24A	1771-A3B1	none
1771-A4B	panel	610 x 315 x 193mm (24.0 x 12.4 x 7.6 inches)	7.3kg (16lbs)	16	24A	1771-A4B	1771-A4
	Operating Temperature	Storage Temperature	Relative Humidity		CSA Certification (when product is marked)		
All Chassis	0° to 60°C 32° to 140°F	-40° to 85°C (-40° to 185°F)	5 to 95% (without condensation)		Class 1, Division 2, Groups A, B, C and D		

## Notes



**ALLEN-BRADLEY**  
A ROCKWELL INTERNATIONAL COMPANY

Allen-Bradley has been helping its customers improve productivity and quality for 90 years. A-B designs, manufactures and supports a broad range of control and automation products worldwide. They include logic processors, power and motion control devices, man-machine interfaces and sensors. Allen-Bradley is a subsidiary of Rockwell International, one of the world's leading technology companies.



With major offices worldwide.

Algeria • Argentina • Australia • Austria • Bahrain • Belgium • Brazil • Bulgaria • Canada • Chile • China, PRC • Colombia • Costa Rica • Croatia • Cyprus • Czech Republic • Denmark • Ecuador • Egypt • El Salvador • Finland • France • Germany • Greece • Guatemala • Honduras • Hong Kong • Hungary • Iceland • India • Indonesia • Israel • Italy • Jamaica • Japan • Jordan • Korea • Kuwait • Lebanon • Malaysia • Mexico • New Zealand • Norway • Oman • Pakistan • Peru • Philippines • Poland • Portugal • Puerto Rico • Qatar • Romania • Russia-CIS • Saudi Arabia • Singapore • Slovakia • Slovenia • South Africa, Republic • Spain • Switzerland • Taiwan • Thailand • The Netherlands • Turkey • United Arab Emirates • United Kingdom • United States • Uruguay • Venezuela • Yugoslavia

World Headquarters, Allen-Bradley, 1201 South Second Street, Milwaukee, WI 53204 USA, Tel: (1) 414 382-2000 Fax: (1) 414 382-4444