

Ethernet Tap

Catalog Numbers 1783-ETAP, 1783-ETAP1F, 1783-ETAP2F



ATTENTION: Read this document and the documents listed in the Additional Resources section about installation, configuration and operation of this equipment before you install, configure, operate or maintain this product. Users are required to familiarize themselves with installation and wiring instructions in addition to requirements of all applicable codes, laws, and standards.

Activities including installation, adjustments, putting into service, use, assembly, disassembly, and maintenance are required to be carried out by suitably trained personnel in accordance with applicable code of practice.

If this equipment is used in a manner not specified by the manufacturer, the protection provided by the equipment may be impaired.

注意: 在安装、配置、操作和维护本产品前，请阅读本文档以及“其他资源”部分列出的有关设备安装、配置和操作的相应文档。除了所有适用规范、法律和标准的相关要求之外，用户还必须熟悉安装和接线说明。

安装、调整、投运、使用、组装、拆卸和维护等各项操作必须由经过适当训练的专业人员按照适用的操作规范实施。

如果未按照制造商指定的方式使用该设备，则可能会损害设备提供的保护。

ATENCIÓN: Antes de instalar, configurar, poner en funcionamiento o realizar el mantenimiento de este producto, lea este documento y los documentos listados en la sección Recursos adicionales acerca de la instalación, configuración y operación de este equipo. Los usuarios deben familiarizarse con las instrucciones de instalación y cableado y con los requisitos de todos los códigos, leyes y estándares vigentes.

El personal debidamente capacitado debe realizar las actividades relacionadas a la instalación, ajustes, puesta en servicio, uso, ensamblaje, desensamblaje y mantenimiento de conformidad con el código de práctica aplicable.

Si este equipo se usa de una manera no especificada por el fabricante, la protección provista por el equipo puede resultar afectada.

ATENÇÃO: Leia este e os demais documentos sobre instalação, configuração e operação do equipamento que estão na seção Recursos adicionais antes de instalar, configurar, operar ou manter este produto. Os usuários devem se familiarizar com as instruções de instalação e fiação além das especificações para todos os códigos, leis e normas aplicáveis.

É necessário que as atividades, incluindo instalação, ajustes, colocação em serviço, utilização, montagem, desmontagem e manutenção sejam realizadas por pessoal qualificado e especializado, de acordo com o código de prática aplicável.

Caso este equipamento seja utilizado de maneira não estabelecida pelo fabricante, a proteção fornecida pelo equipamento pode ficar prejudicada.

ВНИМАНИЕ: Перед тем как устанавливать, настраивать, эксплуатировать или обслуживать данное оборудование, прочитайте этот документ и документы, перечисленные в разделе «Дополнительные ресурсы». В этих документах изложены сведения об установке, настройке и эксплуатации данного оборудования. Пользователи обязаны ознакомиться с инструкциями по установке и прокладке соединений, а также с требованиями всех применимых норм, законов и стандартов.

Все действия, включая установку, наладку, ввод в эксплуатацию, использование, сборку, разборку и техническое обслуживание, должны выполняться обученным персоналом в соответствии с применимыми нормами и правилами.

Если оборудование используется не предусмотренным производителем образом, защита оборудования может быть нарушена.

注意: 本製品を設置、構成、稼働または保守する前に、本書および本機器の設置、設定、操作についての参考資料の該当箇所に記載されている文書に目を通してください。ユーザは、すべての該当する条例、法律、規格の要件に加えて、設置および配線の手順に習熟している必要があります。

設置調整、運転の開始、使用、組立て、解体、保守を含む諸作業は、該当する実施規則に従って訓練を受けた適切な作業員が実行する必要があります。

本機器が製造メーカーにより指定されていない方法で使用されている場合、機器により提供されている保護が損なわれる恐れがあります。

ACHTUNG: Lesen Sie dieses Dokument und die im Abschnitt „Literaturverweise“ genannten Dokumente zur Installation, Konfiguration und Bedienung dieser Ausrüstung sorgfältig durch, bevor Sie dieses Produkt installieren, konfigurieren, bedienen oder instandsetzen. Benutzer müssen sich mit den Anweisungen zur Installation und Verdrahtung vertraut machen und müssen die Anforderungen aller geltenden Vorschriften, Gesetze und Normen kennen.

Aktivitäten wie Installation, Einstellung, Inbetriebnahme, Verwendung, Montage, Demontage und Instandsetzung müssen durch ausreichend geschultes Personal in Übereinstimmung mit den geltenden Durchführungsvorschriften ausgeführt werden.

Wenn diese Ausrüstung in einer Weise verwendet wird, die nicht vom Hersteller angegeben wurde, kann der von der Ausrüstung bereitgestellte Schutz beeinträchtigt sein.

ATTENTION: Lisez ce document et les documents listés dans la section Ressources complémentaires relatifs à l'installation, la configuration et le fonctionnement de cet équipement avant d'installer, configurer, utiliser ou entretenir ce produit. Les utilisateurs doivent se familiariser avec les instructions d'installation et de câblage en plus des exigences relatives aux codes, lois et normes en vigueur.

Les activités relatives à l'installation, le réglage, la mise en service, l'utilisation, l'assemblage, le démontage et l'entretien doivent être réalisées par des personnes formées selon le code de pratique en vigueur.

Si cet équipement est utilisé d'une façon qui n'a pas été définie par le fabricant, la protection fournie par l'équipement peut être compromise.

주의: 본 제품 설치, 설정, 작동 또는 유지 보수하기 전에 본 문서를 포함하여 설치, 설정 및 작동에 관한 참고 자료 섹션의 문서들을 반드시 읽고 숙지하십시오. 사용자는 모든 관련 규정, 법규 및 표준에서 요구하는 사항에 대해 반드시 설치 및 배선 지침을 숙지해야 합니다.

설치, 조정, 가동, 사용, 조립, 분해, 유지보수 등 모든 작업은 관련 규정에 따라 적절한 교육을 받은 사용자를 통해서만 수행해야 합니다.

본 장비를 제조사가 명시하지 않은 방법으로 사용하면 장비의 보호 기능이 손상될 수 있습니다.

ATTENZIONE Prima di installare, configurare ed utilizzare il prodotto, o effettuare interventi di manutenzione su di esso, leggere il presente documento ed i documenti elencati nella sezione "Altre risorse", riguardanti l'installazione, la configurazione ed il funzionamento dell'apparecchiatura. Gli utenti devono leggere e comprendere le istruzioni di installazione e cablaggio, oltre ai requisiti previsti dalle leggi, codici e standard applicabili.

Le attività come installazione, regolazioni, utilizzo, assemblaggio, disassemblaggio e manutenzione devono essere svolte da personale adeguatamente addestrato, nel rispetto delle procedure previste.

Qualora l'apparecchio venga utilizzato con modalità diverse da quanto previsto dal produttore, la sua funzione di protezione potrebbe venire compromessa.

DİKKAT: Bu ürünün kurulumu, yapılandırılması, işletilmesi veya bakımı öncesinde bu dokümanı ve bu ekipmanın kurulumu, yapılandırılması ve işletimi ile ilgili ilave Kaynaklar bölümünde yer listelenmiş dokümanları okuyun. Kullanıcılar yürürlükteki tüm yönetmelikler, yasalar ve standartların gereksinimlerine ek olarak kurulum ve kablolama talimatlarını da öğrenmek zorundadır.

Kurulum, ayarlar, hizmete alma, kullanma, parçaları birleştirme, parçaları sökme ve bakım gibi aktiviteler sadece uygun eğitimli almış kişiler tarafından yürürlükteki uygulama yönetmeliklerine uygun şekilde yapılabilir.

Bu ekipman üretici tarafından belirlenmiş amacın dışında kullanılırsa, ekipman tarafından sağlanan koruma bozulabilir.

注意事項: 在安装、設定、操作或維護本產品前，請先閱讀此文件以及列於「其他資源」章節中有關安裝、設定與操作此設備的文件。使用者必須熟悉安裝和配線指示，並符合所有法規、法律和標準要求。

包括安裝、調整、交付使用、使用、組裝、拆卸和維護等動作都必須交由已經過適當訓練的人員進行，以符合適用的實作法規。

如果將設備用於非製造商指定的用途時，可能會造成設備所提供的保護功能受損。

POZOR: Než začnete instalovat, konfigurovat či provozovat tento výrobek nebo provádět jeho údržbu, přečtěte si tento dokument a dokumenty uvedené v části Dodatečné zdroje ohledně instalace, konfigurace a provozu tohoto zařízení.

Uživatelé se musejí vedle požadavků všech relevantních vyhlášek, zákonů a norem nutně seznámit také s pokyny pro instalaci a elektrické zapojení.

Činnosti zahrnující instalaci, nastavení, uvedení do provozu, užívání, montáž, demontáž a údržbu musí vykonávat vhodné proškolený personál v souladu s příslušnými prováděcími předpisy.

Pokud se toto zařízení používá způsobem neodpovídajícím specifikaci výrobce, může být narušena ochrana, kterou toto zařízení poskytuje.

UWAGA: Przed instalacją, konfiguracją, użytkowaniem lub konserwacją tego produktu należy przeczytać niniejszy dokument oraz wszystkie dokumenty wymienione w sekcji Dodatkowe źródła omawiające instalację, konfigurację i procedury użytkowania tego urządzenia. Użytkownicy mają obowiązek zapoznać się z instrukcjami dotyczącymi instalacji oraz oprzewodowania, jak również z obowiązującymi kodeksami, prawem i normami.

Działania obejmujące instalację, regulację, przekazanie do użytkowania, użytkowanie, montaż, demontaż oraz konserwację muszą być wykonywane przez odpowiednio przeszkolony personel zgodnie z obowiązującym kodeksem postępowania.

Jeśli urządzenie jest użytkowane w sposób inny niż określony przez producenta, zabezpieczenie zapewniane przez urządzenie może zostać ograniczone.

ÖBS! Läs detta dokument samt dokumentet, som står listat i avsnittet Övriga resurser, om installation, konfigurering och drift av denna utrustning innan du installerar, konfigurerar eller börjar använda eller utföra underhållsarbete på produkten. Användare måste bekanta sig med instruktioner för installation och kabeldragning, förutom krav enligt gällande koder, lagar och standarder.

Åtgärder som installation, justering, service, användning, montering, demontering och underhållsarbete måste utföras av personal med lämplig utbildning enligt lämpligt bruk.

Om denna utrustning används på ett sätt som inte anges av tillverkaren kan det hända att utrustningens skyddsanordning försätts ur funktion.

LET OP: Lees dit document en de documenten die genoemd worden in de paragraaf Aanvullende informatie over de installatie, configuratie en bediening van deze apparatuur voordat u dit product installeert, configureert, bedient of onderhoudt. Gebruikers moeten zich vertrouwd maken met de installatie en de bedradingsinstructies, naast de vereisten van alle toepasselijke regels, wetten en normen.

Activiteiten zoals het installeren, afstellen, in gebruik stellen, gebruiken, monteren, demonteren en het uitvoeren van onderhoud mogen uitsluitend worden uitgevoerd door hiervoor opgeleid personeel en in overeenstemming met de geldende praktijkregels.

Indien de apparatuur wordt gebruikt op een wijze die niet is gespecificeerd door de fabrikant, dan bestaat het gevaar dat de beveiliging van de apparatuur niet goed werkt.

North American Hazardous Location Approval

The following information applies when operating this equipment in hazardous locations: Products marked "CL I, DIV 2, GP A, B, C, D" are suitable for use in Class I Division 2 Groups A, B, C, D, Hazardous Locations and nonhazardous locations only. Each product is supplied with markings on the rating nameplate indicating the hazardous location temperature code. When combining products within a system, the most adverse temperature code (lowest "T" number) may be used to help determine the overall temperature code of the system. Combinations of equipment in your system are subject to investigation by the local authority having jurisdiction at the time of installation.



WARNING: EXPLOSION HAZARD

- Do not disconnect equipment unless power has been removed or the area is known to be nonhazardous.
- Do not disconnect connections to this equipment unless power has been removed or the area is known to be nonhazardous. Secure any external connections that mate to this equipment by using screws, sliding latches, threaded connectors, or other means provided with this product.
- Substitution of components may impair suitability for Class I, Division 2.
- If this product contains batteries, they must be changed only in an area known to be nonhazardous.

Informations sur l'utilisation de cet équipement en environnements dangereux:

Les produits marqués "CL I, DIV 2, GP A, B, C, D" ne conviennent qu'à une utilisation en environnements de Classe I Division 2 Groupes A, B, C, D dangereux et non dangereux. Chaque produit est livré avec des marquages sur sa plaque d'identification qui indiquent le code de température pour les environnements dangereux. Lorsque plusieurs produits sont combinés dans un système, le code de température le plus défavorable (code de température le plus faible) peut être utilisé pour déterminer le code de température global du système. Les combinaisons d'équipements dans le système sont sujettes à inspection par les autorités locales qualifiées au moment de l'installation.



AVERTISSEMENT: RISQUE D'EXPLOSION

- Couper le courant ou s'assurer que l'environnement est classé non dangereux avant de débrancher l'équipement.
- Couper le courant ou s'assurer que l'environnement est classé non dangereux avant de débrancher les connecteurs. Fixer tous les connecteurs externes reliés à cet équipement à l'aide de vis, loquets coulissants, connecteurs filetés ou autres moyens fournis avec ce produit.
- La substitution de composants peut rendre cet équipement inadapté à une utilisation en environnement de Classe I, Division 2.
- S'assurer que l'environnement est classé non dangereux avant de changer les piles.

European Hazardous Location Approval

The following applies to products marked   II 3 G: Such modules:

- Are Equipment Group II, Equipment Category 3, and comply with the Essential Health and Safety Requirements relating to the design and construction of such equipment given in Annex II to Directive 94/9/EC. See the EC Declaration of Conformity at <http://www.rockwellautomation.com/products/certification> for details. The type of protection for the 1783-ETAP is "Ex nA IIC T5 Gc", and the type of protection for the 1783-ETAP1F, and 1783-ETAP2F is "Ex nA IIC T4 Gc" according to EN 60079-15.
- Catalog numbers may be followed by a "K" to indicate a conformal coating option.
- Are intended for use in areas in which explosive atmospheres caused by gases, vapors, mists, or air are unlikely to occur, or are likely to occur only infrequently and for short periods. Such locations correspond to Zone 2 classification according to ATEX directive 1999/92/EC.
- Comply to Standards: EN 60079-0:2012, EN 60079-15:2010, reference certificate number DEMKO 13 ATEX 1342963X.



ATTENTION: This equipment is not resistant to sunlight or other sources of UV radiation.



WARNING: Special Conditions for Safe Use:

- This equipment shall be mounted in an ATEX/IECEx Zone 2 certified enclosure with a minimum ingress protection rating of at least IP54 (as defined in IEC/EN 60529) and used in an environment of not more than Pollution Degree 2 (as defined in IEC/EN 60664-1) when applied in Zone 2 environments. The enclosure must be accessible only by the use of a tool.
- This equipment shall be used within its specified ratings defined by Rockwell Automation.
- Secure any external connections that mate to this equipment by using screws, sliding latches, threaded connectors, or other means provided with this product.
- Do not disconnect equipment unless power has been removed or the area is known to be nonhazardous.
- Provision shall be made to prevent the rated voltage from being exceeded by transient disturbances of more than 140% of the rated voltage when applied in Zone 2 environments.
- This equipment must be used only with ATEX/IECEx certified Rockwell Automation backplanes.
- Instructions in the user manual shall be observed.

IEC Hazardous Location Approval

The following applies to products marked IECEx:

- Such modules are intended for use in areas in which explosive atmospheres caused by gases, vapors, mists, or air are unlikely to occur, or are likely to occur only infrequently and for short periods. Such locations correspond to Zone 2 classification to IEC 60079-0.
- The type of protection for the 1783-ETAP is "Ex nA IIC T5 Gc" according to IEC 60079-15. The type of protection for the 1783-ETAP1F and 1783-ETAP2F is "Ex nA IIC T4 Gc" according to IEC 60079-15.
- Such modules comply to Standards IEC 60079-0:2011, IEC-60079-15:2010, reference IECEx certificate number IECEx UL 14.0092X.

Environment and Enclosure



ATTENTION: This equipment is intended for use in a Pollution Degree 2 industrial environment, in overvoltage Category II applications (as defined in EN 60664-1), at altitudes up to 2000 m (6562 ft) without derating.

This equipment is considered Group 1, Class A industrial equipment according to IEC/CISPR 11. Without appropriate precautions, there may be difficulties with electromagnetic compatibility in residential and other environments due to conducted and radiated disturbances.

This equipment is supplied as open-type equipment. It must be mounted within an enclosure that is suitably designed for those specific environmental conditions that will be present and appropriately designed to prevent personal injury resulting from accessibility to live parts. The enclosure must have suitable flame-retardant properties to prevent or minimize the spread of flame, complying with a flame spread rating of 5VA, V2, V1, V0 (or equivalent) if non-metallic. The interior of the enclosure must be accessible only by the use of a tool. Subsequent sections of this publication may contain additional information regarding specific enclosure type ratings that are required to comply with certain product safety certifications.

In addition to this publication, see the following:

- Industrial Automation Wiring and Grounding Guidelines, Rockwell Automation publication [1770-4.1](#), for additional installation requirements
- NEMA 250 and EN 60529, as applicable, for explanations of the degrees of protection provided by different types of enclosures

Prevent Electrostatic Discharge



ATTENTION: This equipment is sensitive to electrostatic discharge, which can cause internal damage and affect normal operation. Follow these guidelines when you handle this equipment:

- Touch a grounded object to discharge potential static.
- Wear an approved grounding wriststrap.
- Do not touch connectors or pins on component boards.
- Do not touch circuit components inside the equipment.
- Use a static-safe workstation, if available.
- Store the equipment in appropriate static-safe packaging when not in use.

Linear and Star Network Considerations

When using the tap in a linear or star network, be sure that Ring Supervisor mode is not enabled. By default, the tap is configured to be a non-supervisor ring node.

IMPORTANT

- For 1783-ETAP, 1783-ETAP1F, and 1783-ETAP2F modules running firmware revision 2.001 or later, DIP switch 3 is used to make the tap a ring supervisor in a DLR network. To avoid adversely impacting communication in a linear or star network, take these precautions:
- Make sure switch 3 remains in the Off position. If switch 3 is in the On position, the tap will be automatically enabled as a ring supervisor.
 - Make sure the Ring Supervisor mode is not enabled in RSLinx® Classic software or the Studio 5000 Logix Designer™ application. When switch 3 is in the Off position, the programming software controls whether the tap is a ring supervisor.

Device-level Ring (DLR) Network Considerations

When using the tap in a DLR network, consider whether the tap will be a ring supervisor. By default, the tap is configured to be a non-supervisor ring node. Use one of these methods for controlling supervisor functionality:

- Use RSLinx Classic software or the Studio 5000 Logix Designer application to set the Ring Supervisor mode and other supervisor-related parameters. This is the default method. If you choose this option, follow the procedures outlined in the online help that accompanies the software to enable Ring Supervisor mode.
- Use the DIP switches to automatically enable Ring Supervisor mode with the current supervisor-related parameters stored in the tap's memory.¹ Refer to [Set the DIP Switches on page 5](#) for additional information.

IMPORTANT

- Use these precautions when setting up a DLR network:
- Make sure at least one node is acting as supervisor before connecting the last link of a DLR network and physically closing the ring.
 - Do not connect nodes that do not support a DLR as members of the ring.

Grounding Considerations

This product is intended to be mounted to a well-grounded mounting surface, such as a metal pane or DIN rail.



ATTENTION: This product is grounded through the DIN rail to chassis ground. Use zinc-plated yellow-chromate steel DIN rail to assure proper grounding. The use of other DIN rail materials (for example, aluminum or plastic) that can corrode, oxidize, or are poor conductors, can result in improper or intermittent grounding. Secure the DIN rail to mounting surface approximately every 200 mm (7.8 in.) and use end-anchors appropriately.

Refer to the Industrial Automation Wiring and Grounding Guidelines, publication [1770-4.1](#), for additional information.

¹ Using switch 3 to control Ring Supervisor mode is supported only on 1783-ETAP modules running firmware revision 2.001 or later.

1783-ETAP Module Components

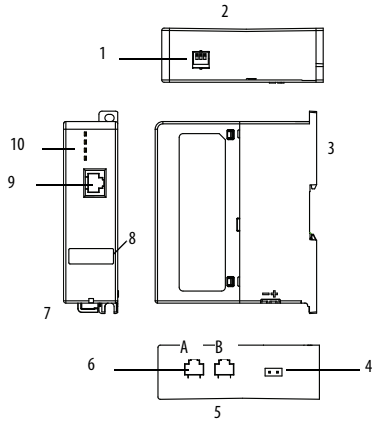

Item	Description	Item	Description
1	DIP switches	6	Ports for connection to linear or ring network A: Port 1 B: Port 2
2	Top view	7	Front view
3	Side view	8	MAC ID label
4	DC connector	9	Device port on front panel
5	Bottom view	10	Status indicators

By default, the individual ports on the tap auto-negotiate link speeds (10 Mbps or 100 Mbps) and duplex setting (full or half).

IMPORTANT Configure the Ethernet port on the device you connect to a tap so that it matches the tap's speed and duplex settings. Failure to make the speed and duplex settings of directly-connected devices match may result in higher error rates, or loss of network connectivity.

1783-ETAP1F, 1783-ETAP2F Module Components

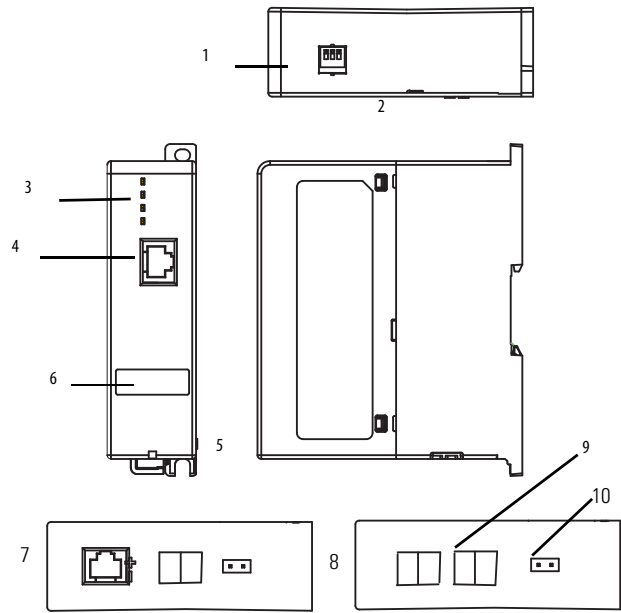

Item	Description	Item	Description
1	DIP switches	6	MAC ID label
2	Top view	7	Bottom view, 1783-ETAP1F
3	Status indicators	8	Bottom view, 1783-ETAP2F
4	Device port on front panel	9	Ports for connection to linear or ring network ⁽¹⁾
5	Side view	10	DC connector

(1) The 1783-ETAP2F tap has two fiber-optic ports. The 1783-ETAP1F tap has one fiber-optic port.

By default, the 10BASE-T and 100BASE-TX ports on the tap autonegotiate link speeds (10 Mbps or 100 Mbps) and duplex setting (full or half). The 100BASE-FX fiber interfaces provide 100 Mbps, full duplex operation.

IMPORTANT Configure the Ethernet port on the device you connect to a tap so that it matches the tap's speed and duplex settings. Failure to make the speed and duplex settings of directly-connected devices match may result in higher error rates or loss of network connectivity.

Software Requirements

You must have these versions of software.

Software	Version
RSLink Classic	2.56.00 or later
Studio 5000 Logix Designer	21.00.00 or later

Install the Tap



WARNING: For hazardous location applications, use the supplied Phoenix™ MSTB 2.5/2-ST-5.08 power terminal block.

Follow these procedures to install the tap.

1. Mount the tap in one of these configurations:
 - Panel mount
 - DIN rail mount
 2. Wire the tap.
 3. Connect the Ethernet ports.
 4. Download the tap Add-on Profile (AOP) if you are using the Studio 5000 Logix Designer application, version 17.01.
 5. Download the EDS file for the tap.
 6. Configure Internet Protocol settings.
 7. Set the DIP switches.
- This publication describes these steps in detail.

Mount the Tap

Install the tap on a DIN rail or panel-mount the tap.

IMPORTANT For 1783-ETAP modules:
When mounting the tap, allow a minimum clearance between product and adjacent equipment of 2.54 cm (1 in.) on all sides.

IMPORTANT For 1783-ETAP1F, 1783-ETAP2F modules:
 • When mounting the tap, be sure to provide 7.62 cm (3 in.) of space on the bottom side of the tap and 2.54 cm (1 in.) of space on the remaining sides of the tap.
 • Allow at least 5.08 cm (2 in.) for the fiber cable bend radius. Contact the cable manufacturer for more information on recommended cable bend radii.

DIN Rail Mounting

To install the tap on a DIN rail, proceed as follows.

1. Mount your DIN rail.
 2. Use a screwdriver to open the latch at the bottom of the tap.
 3. Hook the latch over the DIN rail while holding the latch open with your screwdriver.
 4. Remove the screwdriver and push the latch to close.
- The top figure shows using a screwdriver to open the latch so that you can remove the tap from the DIN rail. The bottom figure shows the latch at the bottom of the tap in the open position.

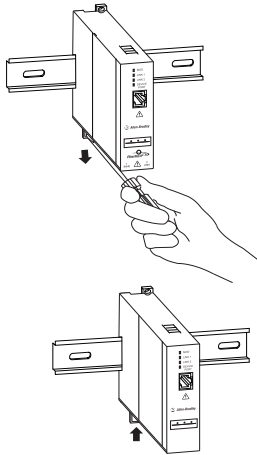

Panel Mounting

To panel mount a tap, proceed as follows.

1. Use the tap as a template and mark pilot holes on your panel.
2. Drill the pilot holes for M4 or #8 screws.

Wire the Tap



WARNING: An electrical arc can occur if you connect or disconnect the following:

- Communication cable with power applied to this module or any device on the network
- Wiring while the field-side power is on

This could cause an explosion in hazardous location installations. Be sure that power is removed or the area is nonhazardous before proceeding.

For hazardous location applications, use the supplied Phoenix MSTB 2.5/2-ST-5.08 power terminal block.



ATTENTION: To comply with the CE Low Voltage Directive (LVD), this equipment must be powered from a source compliant with safety extra low voltage (SELV) or protected extra low voltage (PELV).

To comply with UL restrictions, this equipment must be powered from a source compliant with Class 2.

Provide DC power to the tap by using the DC connector at the bottom of the tap.



ATTENTION: Do not wire more than two conductors on any single terminal.

1783-ETAP Terminals

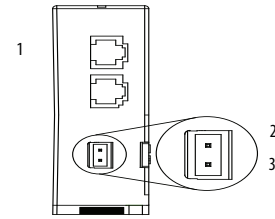

Item	Description
1	Tap bottom
2	DC- (0V DC) terminal
3	DC+ (24V DC nom) terminal

1783-ETAP1F, 1783-ETAP2F Terminals

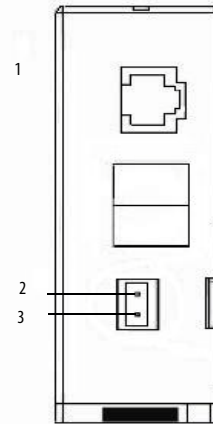

Item	Description
1	Tap bottom
2	DC- (0V DC) terminal
3	DC+ (24V DC nom) terminal

Connect the RJ45 Ports

Follow these steps to connect the copper Ethernet ports on the tap.

1. Locate the copper Ethernet RJ45 ports on the front and bottom of the tap, as shown in the figure.

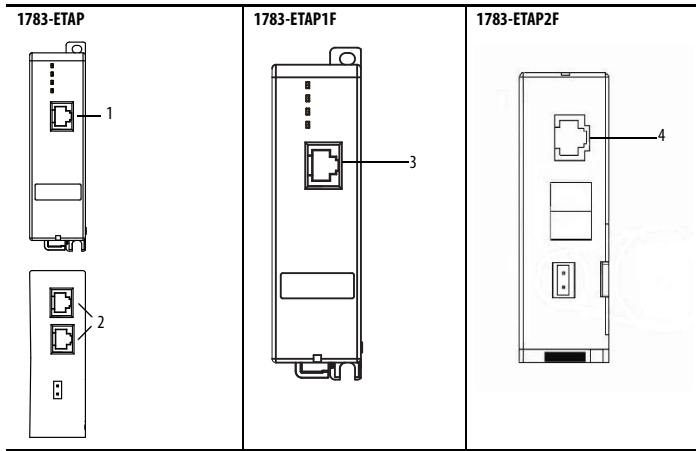

Item	Description
1	Device port on 1783-ETAP module front panel
2	Ports on 1783-ETAP module bottom for connection to the linear or ring network
3	Device port on 1783-ETAP1F module front panel
4	RJ45 port on 1783-ETAP2F module bottom for connection to a linear, star, or ring network

2. Connect one end of an Ethernet cable to the front panel port used as a device port.
3. Connect the other end of the Ethernet cable to the appropriate device in your network.
4. Connect one end of a second Ethernet cable to a port at the bottom of the tap and connect the other end of the Ethernet cable to the linear or ring network.
5. Repeat with the other port at the bottom of the tap if the port is used by your network.

IMPORTANT When setting up a DLR, refer to [Device-Level Ring \(DLR\) Network Considerations on page 2](#) to avoid adversely impacting your network.

Connect the 1783-ETAP1F and 1783-ETAP2F Fiber Ethernet Ports

Follow these steps to connect the fiber Ethernet ports on 1783-ETAP1F and 1783-ETAP2F modules.

ATTENTION: Do not look at the optical port. The optical port can expose the eye beyond the maximum permissible exposure recommendations and presents a hazard.

1. Locate the fiber Ethernet ports on the bottom of the tap, as shown in the figure (1783-ETAP2F tap shown).

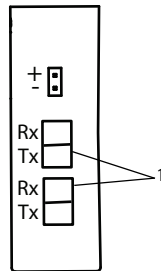

Item	Description
1	Fiber ports on tap bottom for connection to the ring network

2. Connect the duplex LC connector end of the fiber-optic cable, in the proper orientation, to the fiber-optic Ethernet port on the bottom of the tap.

3. Connect the other end of the fiber-optic cable to the linear or ring network.
4. Repeat step 2 and step 3 with the remaining fiber-optic Ethernet port at the bottom of the tap, if used by your network.

Download the EDS File

To use RSLinx Classic communication software to configure the tap, follow these steps to download the EDS file for the tap.

1. Obtain the EDS file from <http://www.rockwellautomation.com/resources/eds/>.
2. From the Network pull-down menu, choose the EtherNet/IP network.
3. From the Device Type pull-down, choose Communication Adapter.
4. In the Bulletin/catalog number field, type 1783-ETAP.
5. Click Search.
6. Click Download to download the EDS file for the tap.
7. Save the file to an appropriate location on your computer.
8. Use your configuration software to register the downloaded file.
 - a. If you are using RSLinx Classic communication software, use the EDS Hardware Installation Tool.
 - b. Choose Start>All Programs>Rockwell Software>RSLinx>Tools.

Configure Internet Protocol Settings

Configure Internet Protocol (IP) settings, such as the IP address, in one of these ways:

- Use the tap's default IP address of 169.254.1.1 by connecting the tap directly to a computer. To establish communication between a computer and the tap's default IP address, you have the following options:
 - Enter a unique IP address in the local area connection properties for your computer. The computer's IP address must be on the same subnet as the tap's default IP address, such as 169.254.1.2.
 - Set up your computer to obtain its IP address automatically.

IMPORTANT If the port on your personal computer that is connected to the tap is configured to obtain its IP address automatically, expect a wait time of up to two minutes before communication is established after connecting the tap to a computer. If two or more taps are connected to one another, and each tap is using the default IP address, the computer is only able to communicate with the tap to which it is directly connected.

- Use IP settings configured in RSLinx Classic software or the Studio 5000 Logix Designer application.
- Acquire IP settings from a DHCP server.
- Acquire IP settings from a BOOTP server.

Use the DIP switches on the tap to select the configuration method to use for IP settings. Refer to [Set the DIP Switches on page 5](#).

Use the DHCP/BOOTP Server

If your network infrastructure does not provide DHCP/BOOT functionality, you may download our DHCP/BOOTP server software to a personal computer running a Microsoft Windows operating system. You can use this computer as the DHCP/BOOTP server.

To set the network address by using the Rockwell Automation DHCP/BOOTP server, follow these steps.

1. Access the DHCP/BOOTP utility at <http://www.ab.com/networks/ethernet/bootp.html>.
2. Download the version 2.3.2 DHCP/BOOTP utility.
3. Extract the zipped files to a temporary directory.
4. In the temporary directory, double-click setup.exe to install the DHCP/BOOTP utility.
5. Run the utility.
6. Refer to the following chart, which describes what happens next, depending on whether DHCP/BOOTP is enabled on the tap.

DHCP/BOOTP Status	Result
Enabled	Tap asks for an IP address from a DHCP/BOOTP server. Consult the online help available in the BOOTP/DHCP application to configure the server to provide the desired IP address for your tap.
Not enabled	Tap uses the IP settings stored in nonvolatile memory. The default IP address stored in memory is 169.254.1.1.

Set the DIP Switches

Use the DIP switches on the tap to do the following:

- Specify the method for configuring Internet Protocol (IP) settings, such as the IP address.
- Enable the Ring Supervisor mode with its current parameters.
- Restore the factory default settings.

Refer to the illustration to understand DIP switch On and Off positions.

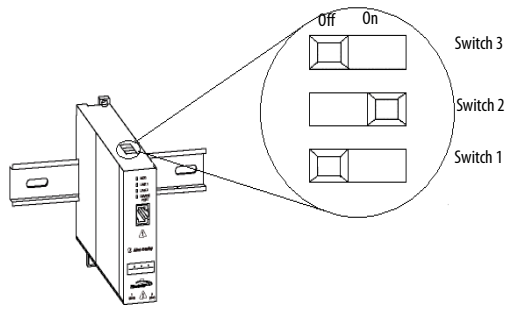

Use this procedure to set the DIP switches.

1. Move the switches to the desired position, and then cycle power to the tap.

IMPORTANT The switch settings take effect only at powerup. The tap's behavior will not be modified by switch changes until the tap is power cycled.

Power-up Behavior		Switch 1	Switch 2	Switch 3
Internet Protocol settings	Uses the IP settings configured by software ⁽¹⁾ or Uses the default IP address of 169.254.1.1 if settings have not been configured by software	Off	Off	The position of switch 3 does not affect IP settings
	Uses the IP settings acquired by a BOOTP server	On	Off	
	Uses the IP settings acquired by a DHCP server	Off	On	
Ring Supervisor mode	Enables Ring Supervisor mode with the current supervisor-related parameters ⁽²⁾	The positions of switches 1 and 2 do not affect Ring Supervisor mode		On ⁽³⁾
	Allows Ring Supervisor mode and supervisor-related parameters to be enabled and configured by software			Off
Restores the factory default settings and then suspends operation		On	On	On or Off

(1) RSLinx Classic software or the Studio 5000 Logix Designer application is required.
 (2) For information about supervisor-related parameters, refer to the EtherNet/IP Embedded Switch Technology Application Guide, publication [ENET-AP005](#).
 (3) Using switch 3 to control Ring Supervisor mode is supported only on 1783-ETAP modules running firmware revision 2.001 or later.

2. Observe these guidelines for use of the DIP switches:
 - Out of the box, all three switches are in the Off position. In this state, the tap is configured to be a non-supervisor ring mode and will respond to the default IP address of 169.254.1.1. If your application does not require access to the tap's diagnostic information or configuration, no further action is required. Otherwise, select alternate DIP switch settings or configure the tap by using RSLinx Classic software or the Studio 5000 Logix Designer application.
 - When a switch is pushed to the left, it is in the Off position.
 - When a switch is pushed to the right, it is in the On position.
 - To select BOOTP, move switch 1 to the On position and switch 2 to the Off position.
 - To select DHCP, move switch 1 to the Off position and switch 2 to the On position.
 - To enable Ring Supervisor mode with the current supervisor-related parameters, move switch 3 to the On position.
 - To restore the factory default settings and suspend operation, move both switch 1 and 2 to the On position. When both switch 1 and 2 are in the On position, the position of switch 3 is ignored. When operation is suspended, the OK status indicator blinks red. To resume normal operation, move the switches to the desired positions and then cycle power to the tap.

Use the Web Interface

The tap supports a Web interface that provides diagnostic read-only information. Follow these steps to access the Web interface.

1. Connect a computer to any of the tap's Ethernet ports.
2. Browse to the tap by entering the tap's IP address (the out-of-the-box default is 169.254.1.1) in your web browser's address bar.

TIP If you configure the tap with an IP address, you can also access the tap Web interface from any computer connected to the network.

3. Click Enter.
You see the 1783-ETAP tap page, which provides general information about the tap.

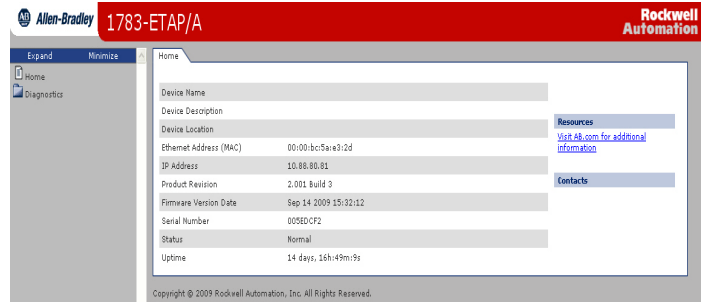

4. In the left pane, click **Diagnostics**.

You see links to these pages:

- Diagnostic Overview
- Network Settings
- Ethernet Statistics
- Ring Statistics

Web Page	Topics
Diagnostic Overview	<ul style="list-style-type: none"> • Module resource utilization • Web server read and write hits • Module settings • Ring status • Network management features
Network Settings	<ul style="list-style-type: none"> • Network interface details, such as IP address and subnet mask • Ethernet Interface configuration method • Ethernet port details
Ethernet Statistics	<ul style="list-style-type: none"> • Ethernet counters • Ethernet port details • Error information
Ring Statistics	Ring supervisor, configuration, and fault details

1783-ETAP Status Indicators

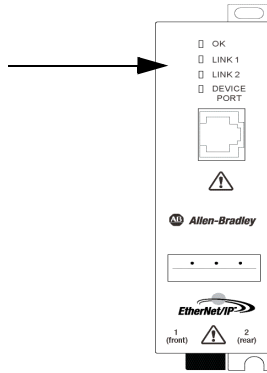

Indicator Description

Indicator	Status	Description
OK	Off	Tap is not powered.
	Flashing green	Tap is not configured.
	Solid green	Tap is powered, configured, and operating correctly.
	Flashing red	Recoverable fault, such as duplicate IP address or update in progress, is detected.
	Solid red	Unrecoverable fault detected.
LINK1, LINK2	Off	One of these conditions exists: <ul style="list-style-type: none"> No link. Port administratively disabled. Port disabled because of rapid ring fault condition, and this tap is the active ring supervisor (LINK 2). Ring network has encountered a rare, partial network fault, and this tap is the active supervisor (LINK 2).
	Green	One of these conditions exists: <ul style="list-style-type: none"> A 100 Mbps (full or half duplex) link exists. The ring network is operating normally and this tap is the active supervisor (LINK 2).
	Flashing green	A 100 Mbps link exists and there is activity.
	Solid yellow	One of these conditions exists: <ul style="list-style-type: none"> A 10 Mbps (full or half duplex) link exists. Ring network is operating normally, and this tap is the active supervisor (LINK 2).
	Flashing yellow	A 10 Mbps link exists and there is activity.

1783-ETAP1F, 1783-ETAP2F Status Indicators

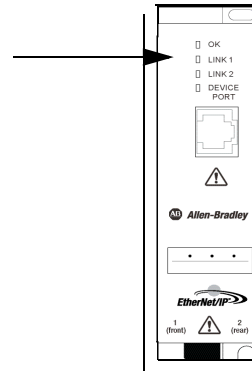

Indicator Description

Indicator	Status	Description
OK	Off	Tap is not powered.
	Flashing green	Tap is not configured.
	Solid green	Tap is powered, configured, and operating correctly.
	Flashing red	Recoverable fault, such as duplicate IP address detected, or an update in progress, is detected.
	Solid red	Unrecoverable fault detected.
LINK 1, LINK 2	Off	One of these conditions exists: <ul style="list-style-type: none"> No link. Port administratively disabled. Ring network has encountered a rare, partial network fault, or rapid ring fault condition, and this tap is the active supervisor (LINK 2).
	Solid green	One of these conditions exists: <ul style="list-style-type: none"> RJ45 port: a 100 Mbps (full or half duplex) link exists, and there is no activity. Fiber port: a 100 Mbps (full duplex) link exists, and there is no activity. Ring network is operating normally, and this tap is the active supervisor (LINK 2).
	Flashing green	A 100 Mbps link exists and there is activity.
	Solid yellow	RJ45 port only. One of these conditions exists: <ul style="list-style-type: none"> A 10 Mbps (full or half duplex) link exists. Ring network is operating normally, and this tap is the active supervisor (LINK 2).
	Flashing yellow	RJ45 port only. A 10 Mbps link exists and there is activity.

Specifications

Attribute	1783-ETAP	1783-ETAP1F	1783-ETAP2F
Power consumption, max	3 W	4.8 W	6.24 W
Current consumption, max	125 mA @ 24V DC	200 mA @ 24V DC	260 mA @ 24V DC
DC power supply voltage rating	24V DC (20.4...27.6V DC)		
Ethernet connections	<ul style="list-style-type: none"> • RJ45 connector according to IEC 60603-7, 2 or 4 pair • Category 5e minimum cable according to TIA 568-B.1 • Category 5 cable according to ISO/IEC 24702 		
DC power connections	<ul style="list-style-type: none"> • One 0.33...3.3 mm² (22...12 AWG) • Two 0.33...1.3 mm² (22...16 AWG) solid • Stranded copper wire rated at 75 °C (167 °F) or greater • 1.2 mm (3/64 in.) insulation max 		
Torque	0.6...0.8 N·m (5...7 lb·in) on power connector		
Temperature, operating IEC 60068-2-1 (Test Ad, Operating Cold) IEC 60068-2-2 (Test Bd, Operating Dry Heat) IEC 60068-2-14 (Test Nb, Operating Thermal Shock)	-25...70 °C (-13...158 °F)	-25...60 °C (-13...140 °F)	
Temperature, surrounding air, max	70 °C (158 °F)	60 °C (140 °F)	

Additional Resources

These documents contain additional information concerning related products from Rockwell Automation.

Resource	Description
Stratix Ethernet Switches Specifications, publication 1783-TD001	Contains technical specifications, environmental specifications, certifications, and other information pertaining to Stratix™ Ethernet switches.

You can view or download publications at <http://www.rockwellautomation.com/literature/>. To order paper copies of technical documentation, contact your local Allen-Bradley distributor or Rockwell Automation sales representative.

Rockwell Automation maintains current product environmental information on its website at <http://www.rockwellautomation.com/rockwellautomation/about-us/sustainability-ethics/product-environmental-compliance.page>

Allen-Bradley, Rockwell Software, RSLinx, Studio 5000 Logix Designer, Phoenix, Stratix, and Rockwell Automation are trademarks of Rockwell Automation, Inc.

Trademarks not belonging to Rockwell Automation are property of their respective companies.

Rockwell Otomasyon Ticaret A.Ş., Kar Plaza İş Merkezi E Blok Kat:6 34752 İçerenköy, İstanbul, Tel: +90 (216) 5698400

www.rockwellautomation.com

Power, Control and Information Solutions Headquarters

Americas: Rockwell Automation, 1201 South Second Street, Milwaukee, WI 53204-2496 USA, Tel: (1) 414.382.2000, Fax: (1) 414.382.4444

Europe/Middle East/Africa: Rockwell Automation NV, Pegasus Park, De Kleetlaan 12a, 1831 Diegem, Belgium, Tel: (32) 2 663 0600, Fax: (32) 2 663 0640

Asia Pacific: Rockwell Automation, Level 14, Core F, Cyberport 3, 100 Cyberport Road, Hong Kong, Tel: (852) 2887 4788, Fax: (852) 2508 1846