

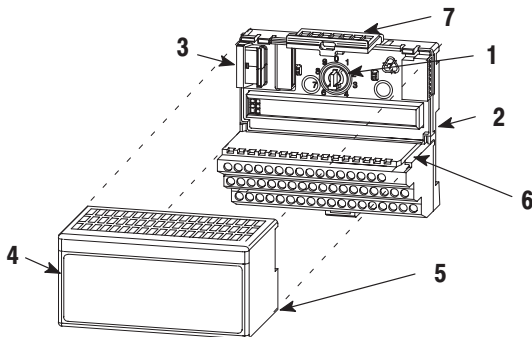

Installation Instructions

English

24V dc FLEX I/O RTD Input Module (Cat. No. 1794-IR8)



Module Installation

This module mounts on a 1794 terminal base unit.

1. Rotate keyswitch (1) on terminal base unit (2) clockwise to position 3 as required for this type of module.
2. Make certain the flexbus connector (3) is pushed all the way to the left to connect with the neighboring terminal base/adaptor. **You cannot install the module unless the connector is fully extended.**
3. Make sure that the pins on the bottom of the module are straight so they will align properly with the connector in the terminal base unit.
4. Position the module (4) with its alignment bar (5) aligned with the groove (6) on the terminal base.
5. Press firmly and evenly to seat the module in the terminal base unit. The module is seated when the latching mechanism (7) is locked into the module.



ATTENTION: Remove field-side power before removing or inserting this module. This module is designed so you can **remove and insert it under backplane power**. When you remove or insert a module with field-side power applied, an electrical arc may occur. An electrical arc can cause personal injury or property damage by:

- sending an erroneous signal to your system's field devices causing unintended machine motion
- causing an explosion in a hazardous environment

Repeated electrical arcing causes excessive wear to contacts on both the module and its mating connector. Worn contacts may create electrical resistance.

European Union Directive Compliance

If this product has the CE mark it is approved for installation within the European Union and EEA regions. It has been designed and tested to meet the following directives.

EMC Directive

This product is tested to meet Council Directive 89/336/EEC Electromagnetic Compatibility (EMC) and the following standards, in whole or in part, documented in a technical construction file:

- EN 50081-2 EMC – Generic Emission Standard, Part 2 – Industrial Environment
- EN 50082-2 EMC – Generic Immunity Standard, Part 2 – Industrial Environment

This product is intended for use in an industrial environment.

Low Voltage Directive

This product is tested to meet Council Directive 73/23/EEC Low Voltage, by applying the safety requirements of EN 61131-2 Programmable Controllers, Part 2 – Equipment Requirements and Tests.

For specific information required by EN 61131-2, see the appropriate sections in this publication, as well as the following Allen-Bradley publications:

- Industrial Automation Wiring and Grounding Guidelines For Noise Immunity, publication 1770-4.1
- Automation Systems Catalog, publication B111

This equipment is classified as open equipment and must be mounted in an enclosure during operation to provide safety protection.

Wiring

1. Connect the individual high and low signal wiring to numbered terminals on the **0–15** row (**A**) on the terminal base unit as indicated in the wiring table.
2. Connect 24V dc common to terminal 16 on row (**B**).



ATTENTION: You must power this module from the same power supply that supplies the adapter module so they both power up or down together. You must cycle power for the adapter to recognize this module.

3. Connect individual channel signal returns to the associated terminal on row (**B**) as shown in the wiring table.

Important: Use the following Belden cables for connecting the RTD to the terminal base unit:

| RTD Type | Length of Run/Humidity Level | Belden Cable Number |
|----------|--|---------------------|
| 2-wire | Not applicable | 9501 |
| 3-wire | Less than 100ft (30.5m) with normal humidity | 9533 |
| | Over 100ft (30.5m) or high humidity ¹ | 83503 |

¹ Greater than 55% for more than 8 hours

4. Connect individual channel shield returns to the associated terminal on row (**B**) for 1794-TB3 and -TB3S or row (**C**) for the 1794-TB3T or -TB3TS as shown in the wiring table.
5. Connect +24V dc to terminal 34 on the **34-51** row (**C**).



ATTENTION: To reduce susceptibility to noise, power analog modules and digital modules from separate power supplies. Do not exceed a length of 33 ft (10m) for dc power cabling.



ATTENTION: Do not daisy chain power or ground from this terminal base unit **to any ac or dc digital module terminal base units.**

6. If daisy-chaining 24V dc common, connect jumper from terminal 33 to terminal 16 on the next terminal base unit.
7. If daisy-chaining +24V dc, connect jumper from terminal 51 to terminal 34 on the next terminal base unit.

4 24V dc FLEX I/O RTD Input Module

8. Connect the shield to functional earth ground as near as possible to the module.



ATTENTION: Total current draw through the terminal base unit is limited to 10A. Separate power connections to the terminal base unit may be necessary.

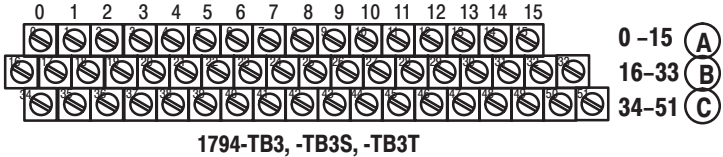

| RTD Channel | 1794-TB3 and -TB3S Terminal Base Units | | | |
|---------------|--|---------------------|----------------------------|---------------|
| | High Signal Terminal | Low Signal Terminal | Signal Return ¹ | Shield Return |
| 0 | 0 | 1 | 17 | 18 |
| 1 | 2 | 3 | 19 | 20 |
| 2 | 4 | 5 | 21 | 22 |
| 3 | 6 | 7 | 23 | 24 |
| 4 | 8 | 9 | 25 | 26 |
| 5 | 10 | 11 | 27 | 28 |
| 6 | 12 | 13 | 29 | 30 |
| 7 | 14 | 15 | 31 | 32 |
| 24V dc Common | 16 thru 33 | | | |
| +24V dc power | 34 thru 51 | | | |

¹ When using a 2-wire RTD, jumper the signal return to the low signal terminal.

| RTD Channel | 1794-TB3T and -TB3TS Terminal Base Units | | | |
|---------------|---|---------------------|---------------|----------------------------|
| | High Signal Terminal | Low Signal Terminal | Signal Return | Shield Return ¹ |
| 0 | 0 | 1 | 17 | 39 |
| 1 | 2 | 3 | 19 | 40 |
| 2 | 4 | 5 | 21 | 41 |
| 3 | 6 | 7 | 23 | 42 |
| 4 | 8 | 9 | 25 | 43 |
| 5 | 10 | 11 | 27 | 44 |
| 6 | 12 | 13 | 29 | 45 |
| 7 | 14 | 15 | 31 | 46 |
| 24V dc Common | 16, 17, 19, 21, 23, 25, 27, 29, 31 and 33 | | | |
| +24V dc power | 34 and 51 | | | |

¹ Terminals 39 to 46 are chassis ground.

Example of 2-, 3- and 4-wire RTD Wiring to a 1794-TB3 Base Unit

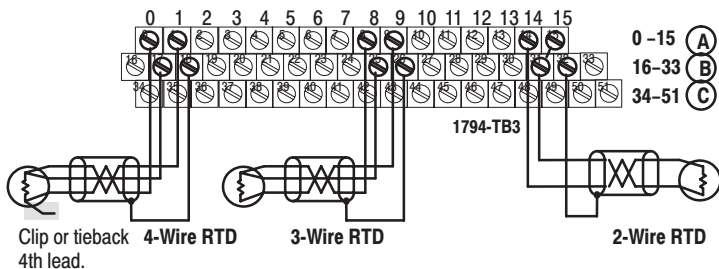

Attention: Keep exposed area of inner conductor as short as possible.

Example of 2-, 3- and 4-wire RTD Wiring to a 1794-TB3T Base Unit

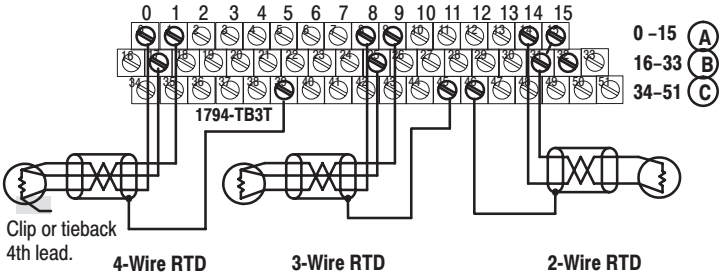

Attention: Keep exposed area of inner conductor as short as possible.

Indicators

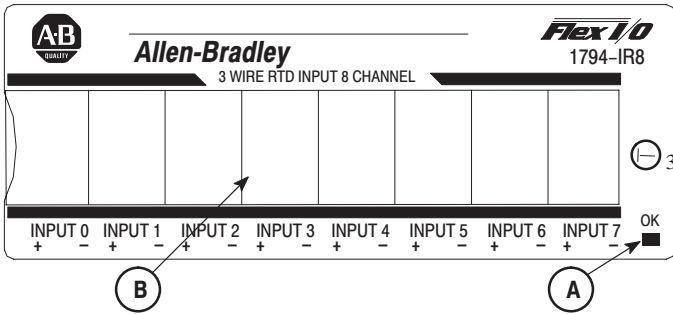

A = Status Indicator – indicates diagnostics results and configuration status.

B = Insertable label for writing individual input designations.

Block Transfer Read and Write

The following block transfer read and write word bit information is presented for experienced users only. Refer to the user manual (publication 1794-6.5.4) for this product for complete information on programming and configuring your module.

Read Words

| Dec. Bit Word | 15 | 14 | 13 | 12 | 11 | 10 | 09 | 08 | 07 | 06 | 05 | 04 | 03 | 02 | 01 | 00 |
|---------------|----------------------|----|----|----|----|---------|---------|---------|-----------------|---------------------|----|--------|------|----|----|----|
| 0 | Reserved | | | | | | | | | | | | | | | |
| 1 | Channel 0 Input Data | | | | | | | | | | | | | | | |
| 2 | Channel 1 Input Data | | | | | | | | | | | | | | | |
| 3 | Channel 2 Input Data | | | | | | | | | | | | | | | |
| 4 | Channel 3 Input Data | | | | | | | | | | | | | | | |
| 5 | Channel 4 Input Data | | | | | | | | | | | | | | | |
| 6 | Channel 5 Input Data | | | | | | | | | | | | | | | |
| 7 | Channel 6 Input Data | | | | | | | | | | | | | | | |
| 8 | Channel 7 Input Data | | | | | | | | | | | | | | | |
| 9 | Overrange Bits | | | | | | | | Underrange Bits | | | | | | | |
| 10 | 0 | 0 | 0 | 0 | 0 | Bad Cal | Cal Dne | Cal Rng | RIUP | Critical Error Bits | | Pwr Up | Res. | 0 | 0 | |

Write Words

| Dec. Bit Word | 15 | 14 | 13 | 12 | 11 | 10 | 09 | 08 | 07 | 06 | 05 | 04 | 03 | 02 | 01 | 00 |
|---------------|------------------------|----|----|----|------------|----|----|----|------------|------------------|---------------|----|------------|-----|----|----|
| 0 | 8-bit Calibration Mask | | | | | | | | Cal Clk | Cal Hi Cal Lo | Filter Cutoff | | Enh | MDT | | |
| 1 | RTD 3 Type | | | | RTD 2 Type | | | | RTD 1 Type | | | | RTD 0 Type | | | |
| 2 | RTD 7 Type | | | | RTD 6 Type | | | | RTD 5 Type | | | | RTD 4 Type | | | |

Where: Enh = Enhanced mode
MDT = Module data type

Data Type

| Word | Description | | |
|--------------|------------------|----|---|
| Write word 0 | Module Data Type | | |
| | 01 | 00 | Bits |
| | 0 | 0 | °C (default) |
| | 0 | 1 | °F |
| | 1 | 0 | Bipolar counts scaled between -32768 and +32767 |
| | 1 | 1 | Unipolar counts scaled between 0 and 65535 |

RTD Type

| Word | Description | | | | | |
|------------------|-------------|----|----|----|----|--|
| RTD Type - Range | | | | | | |
| Write Word 1 | Bit | 03 | 02 | 01 | 00 | Channel 0 |
| | | 0 | 0 | 0 | 0 | Resistance (default) |
| | | 0 | 0 | 0 | 1 | No sensor connected - do not scan |
| | | 0 | 0 | 1 | 0 | 100 ohm Pt $\alpha = 0.00385$ Euro (-200 to +870°C) |
| | | 0 | 0 | 1 | 1 | 100 ohm Pt $\alpha = 0.003916$ U.S. (-200 to +630°C) |
| | | 0 | 1 | 0 | 0 | 200 ohm Pt $\alpha = 0.00385$ Euro (-200 to +630°C) |
| | | 0 | 1 | 0 | 1 | 500 ohm Pt $\alpha = 0.00385$ Euro (-200 to +630°C) |
| | | 0 | 1 | 1 | 0 | Reserved |
| | | 0 | 1 | 1 | 1 | 10 ohm Copper (-200 to +260°C) |
| | | 1 | 0 | 0 | 0 | 120 ohm Nickel (-60 to +250°C) |
| | | 1 | 0 | 0 | 1 | 100 ohm Nickel (-60 to +250°C) |
| | | 1 | 0 | 1 | 0 | 200 ohm Nickel (-60 to +250°C) |
| | | 1 | 0 | 1 | 1 | 500 ohm Nickel (-60 to +250°C) |
| | | 1 | 1 | 0 | 0 | Reserved |

| | | RTD Type - Range | | | | |
|-----------------------------|-----|------------------|----|----|----|------------------------------------|
| Write Word 1 (continued) | Bit | 07 | 06 | 05 | 04 | Channel 1 - see bits 00-03, word 1 |
| | | 11 | 10 | 09 | 08 | Channel 2 - see bits 00-03, word 1 |
| | | 15 | 14 | 13 | 12 | Channel 3 - see bits 00-03, word 1 |
| Write Word 2 | Bit | 03 | 02 | 01 | 00 | Channel 4 - see bits 00-03, word 1 |
| | | 07 | 06 | 05 | 04 | Channel 5 - see bits 00-03, word 1 |
| | | 11 | 10 | 09 | 08 | Channel 6 - see bits 00-03, word 1 |
| | | 15 | 14 | 13 | 12 | Channel 7 - see bits 00-03, word 1 |

CSA Hazardous Location Approval

CSA[®] certifies products for general use as well as for use in hazardous locations. **Actual CSA certification is indicated by the product label** as shown below, and not by statements in any user documentation.

Example of the CSA certification product label



To comply with CSA certification for use in hazardous locations, the following information becomes a part of the product literature for CSA-certified Allen-Bradley industrial control products.

- This equipment is suitable for use in Class I, Division 2, Groups A, B, C, D, or non-hazardous locations only.
 - The products having the appropriate CSA markings (that is, Class I Division 2, Groups A, B, C, D), are certified for use in other equipment where the suitability of combination (that is, application or use) is determined by the CSA or the local inspection office having jurisdiction.
-

Important: Due to the modular nature of a PLC[®] control system, the product with the highest temperature rating determines the overall temperature code rating of a PLC control system in a Class I, Division 2 location. The temperature code rating is marked on the product label as shown.

Temperature code rating

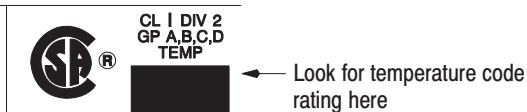

The following warnings apply to products having CSA certification for use in hazardous locations.

CSA Hazardous Location Approval



ATTENTION: Explosion hazard —

- Substitution of components may impair suitability for Class I, Division 2.
- Do not replace components unless power has been switched off or the area is known to be non-hazardous.
- Do not disconnect equipment unless power has been switched off or the area is known to be non-hazardous.
- Do not disconnect connectors unless power has been switched off or the area is known to be non-hazardous. Secure any user-supplied connectors that mate to external circuits on an Allen-Bradley product using screws, sliding latches, threaded connectors, or other means such that any connection can withstand a 15 Newton (3.4 lb.) separating force applied for a minimum of one minute.

Approbation d'utilisation dans des emplacements dangereux par la CSA

La CSA[®] certifie les produits d'utilisation générale aussi bien que ceux qui s'utilisent dans des emplacements dangereux. **La certification CSA en vigueur est indiquée par l'étiquette du produit** et non par des affirmations dans la documentation à l'usage des utilisateurs.

Exemple d'étiquette de certification d'un produit par la CSA



Pour satisfaire à la certification de la CSA dans des endroits dangereux, les informations suivantes font partie intégrante de la documentation des produits industriels de contrôle Allen-Bradley certifiés par la CSA.

- Cet équipement convient à l'utilisation dans des emplacements de Classe I, Division 2, Groupes A, B, C, D, ou ne convient qu'à l'utilisation dans des endroits non dangereux.
- Les produits portant le marquage approprié de la CSA (c'est à dire, Classe I, Division 2, Groupes A, B, C, D) sont certifiés à l'utilisation pour d'autres équipements où la convenance de combinaison (application ou utilisation) est déterminée par la CSA ou le bureau local d'inspection qualifié.

Important: Par suite de la nature modulaire du système de contrôle PLC[®], le produit ayant le taux le plus élevé de température détermine le taux d'ensemble du code de température du système de contrôle d'un PLC dans un emplacement de Classe I, Division 2. Le taux du code de température est indiqué sur l'étiquette du produit.

CSA Hazardous Location Approval

Approbation d'utilisation dans des emplacements dangereux par la CSA

Taux du code de température

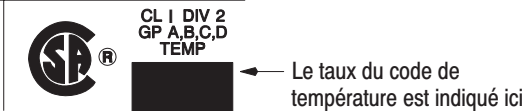

Les avertissements suivants s'appliquent aux produits ayant la certification CSA pour leur utilisation dans des emplacements dangereux.



AVERTISSEMENT: Risque d'explosion —

- La substitution de composants peut rendre ce matériel inacceptable pour les emplacements de Classe I, Division 2.
- Couper le courant ou s'assurer que l'emplacement est désigné non dangereux avant de remplacer les composants.
- Avant de débrancher l'équipement, couper le courant ou s'assurer que l'emplacement est désigné non dangereux.
- Avant de débrancher les connecteurs, couper le courant ou s'assurer que l'emplacement est reconnu non dangereux. Attacher tous connecteurs fournis par l'utilisateur et reliés aux circuits externes d'un appareil Allen-Bradley à l'aide de vis, loquets coulissants, connecteurs filetés ou autres moyens permettant aux connexions de résister à une force de séparation de 15 newtons (3,4 lb. - 1,5 kg) appliquée pendant au moins une minute.

Le sigle CSA est la marque déposée de l'Association des Standards pour le Canada.

PLC est une marque déposée de Allen-Bradley Company, Inc.

CSA logo is a registered trademark of the Canadian Standards Association

PLC is a registered trademark of Allen-Bradley Company, Inc.

| Specifications - 1794-IR8 RTD Input Module | |
|---|---|
| Number of Inputs | 8 Channels |
| Module Location | Cat. No. 1794-TB3, -TB3S, -TB3T, and -TB3TS Terminal Base Units |
| Signal Input Range | 1 to 433 ohms |
| Sensors Supported | Resistance: 100 ohm Pt $\alpha = 0.00385$ Euro (-200 to +870°C) 100 ohm Pt $\alpha = 0.003916$ U.S. (-200 to +630°C) 200 ohm Pt $\alpha = 0.00385$ Euro (-200 to +630°C) 500 ohm Pt $\alpha = 0.00385$ Euro (-200 to +630°C) 100 ohm Nickel $\alpha = 0.00618$ (-60 to +250°C) 120 ohm Nickel $\alpha = 0.00672$ (-60 to +250°C) 200 ohm Nickel $\alpha = 0.00618$ (-60 to +250°C) 500 ohm Nickel $\alpha = 0.00618$ (-60 to +250°C) 10 ohm Copper $\alpha = 0.00427$ (-200 to +260°C) |
| Resolution | 16 bits across 435 ohms |
| Data Format | 16-bit 2's complement or offset binary |
| Normal Mode Noise Rejection | 60db @ 60Hz for A/D filter cutoff @ 10Hz |
| Accuracy without calibration (at low humidity) | Normal mode: 0.05% Full Scale (maximum) Enhanced mode: 0.01% Full Scale (typical) |
| Common Mode Rejection | -120db @ 60Hz; -100db @ 50Hz with A/D filter cutoff @ 10Hz |
| Common Mode Voltage | 0V between channels (common return) |
| System Throughput | Normal mode: Programmable from 28ms/channel to 325ms/channel 325ms (1 channel scanned) 2.6s (8 channels scanned) Enhanced mode: Programmable from 56ms/channel to 650ms/channel 650ms (1 channel scanned) 2.925s (8 channels scanned) |
| Settling Time to 100% of final value | Available at system throughput rate |
| Open RTD Detection | Out of range reading (upscale) |
| Open Wire Detection Time | Available at system throughput rate |
| Overvoltage Capability | 35V dc, 25V ac continuous @ 25°C 250V peak transient |
| Channel Bandwidth | dc to 2.62Hz (-3db) |
| Specifications continued on next page. | |

14 24V dc FLEX I/O RTD Input Module

| Specifications - 1794-IR8 RTD Input Module | |
|---|---|
| RFI Immunity | Error of less than 1% of range at 10V/M 27 to 1000MHz |
| Input Offset Drift with Temperature | 1.5 milliohm/°C maximum |
| Gain Drift with Temperature | Normal mode: 20 ppm/°C maximum Enhanced mode: 10 ppm/°C maximum |
| RTD Excitation Current | 718.39µA |
| Indicators | 1 red/green status indicator |
| Flexbus Current | 20mA |
| Power Dissipation | 3W maximum @ 31.2V dc |
| Thermal Dissipation | Maximum 10.2 BTU/hr @ 31.2V dc |
| Keypad Position | 3 |
| Cable Requirements | 2-wire, Belden 9501 3-wire, less than 100ft (30.5m) with normal humidity- Belden 9533 3-wire, greater than 100ft (30.5m) or high humidity (>55% for >8 hrs)- Belden 83503 |
| General Specifications | |
| External dc Power | |
| Supply Voltage | 24V dc nominal |
| Voltage Range | 19.2 to 31.2V dc (includes 5% ac ripple) 19.2V dc for ambient temperatures < 55°C 24V dc for ambient temperatures < 55°C 31.2V dc for ambient temperatures < 40°C |
| Supply Current | See derating curve. 140mA @ 24V dc |
| Dimensions | |
| Inches | 1.8H x 3.7W x 2.1D |
| (Millimeters) | (45.7 x 94.0 x 53.3) |
| Environmental Conditions | |
| Operational Temperature | 0 to 55°C (32 to 131°F) |
| Storage Temperature | -40 to 85°C (-40 to 185°F) |
| Relative Humidity | 5 to 95% noncondensing (operating) 5 to 80% noncondensing (nonoperating) |
| Shock | |
| Operating | 30 g peak acceleration, 11(±1)ms pulse width |
| Nonoperating | 50 g peak acceleration, 11(±1)ms pulse width |
| Vibration | Tested 5 g @ 10-500Hz per IEC 68-2-6 |
| Specifications continued on next page. | |

Specifications - 1794-IR8 RTD Input Module

| | |
|--|--|
| Agency Certification (when product is marked) | <ul style="list-style-type: none"> • CSA certified • CSA Class I, Division 2 Groups A, B, C, D certified • UL listed • CE marked for all applicable directives |
| User Manual | Publication 1794-6.5.4 |

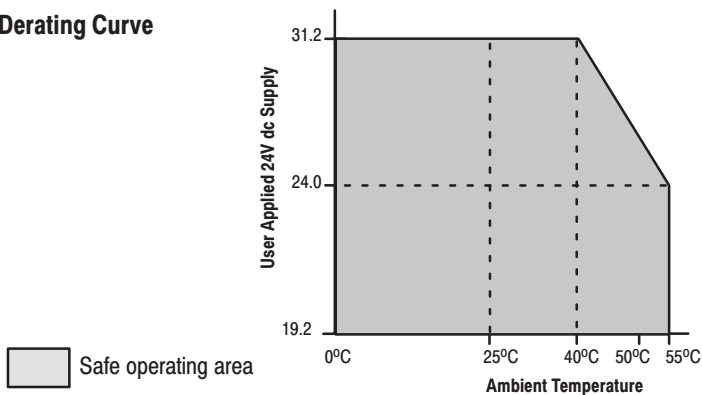
Derating Curve

The area within the curve represents the safe operating range for the module under various conditions of user supplied 24V dc supply voltages and ambient temperatures.

User Manuals

Thank you for purchasing this product. This product has a user manual associated with it. If you would like a manual, you can:

- download a free electronic version from the internet:
www.ab.com/manuals or
www.theautomationbookstore.com
- purchase a printed manual by:
 - contacting your local distributor or Rockwell Automation representative,
 - visiting www.theautomationbookstore.com and placing your order
 - calling 1.800.963.9548 (USA/Canada) or 001.330.725.1574 (Outside USA/Canada)

The publication number of the user manual for your product is listed under "Specifications" in this installation instruction.



With major offices worldwide.

World Headquarters,
Allen-Bradley,
1201 South Second Street,
Milwaukee, WI 53204 USA,
Tel: (1) 414 382-2000 Fax: (1) 414 382-4444