

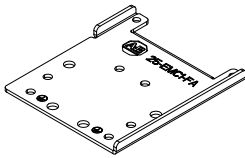

PowerFlex 520-Series EMC Plate Installation

Catalog Numbers: 25-EMC1-FA, 25-EMC1-7FB, 25-EMC1-FC, 25-EMC1-FD, 25-EMC1-FE

Frame A – 25-EMC1-FA



Frame B – 25-EMC1-FB

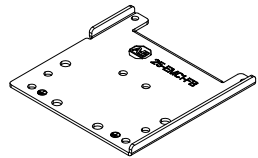

Frame C – 25-EMC1-FC

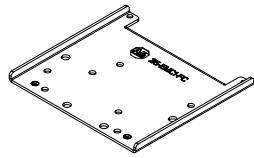

Frame D – 25-EMC1-FD

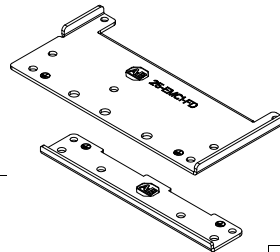

Frame E – 25-EMC1-FE

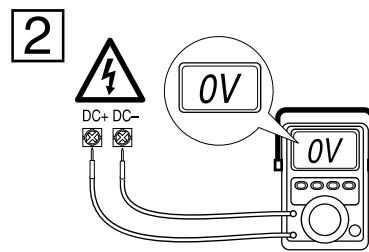
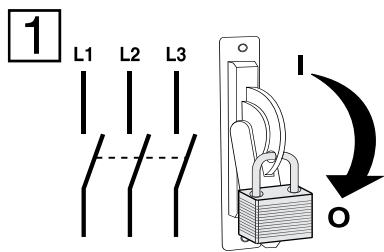
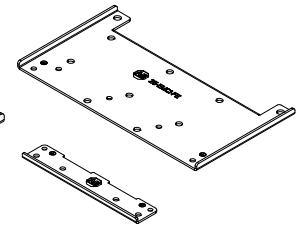

Wait three minutes after shutdown for capacitors to discharge to safe voltage levels.

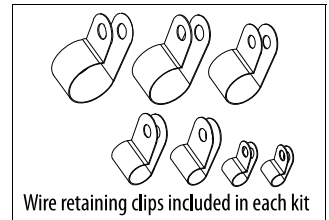

IMPORTANT Grounding and Wiring configuration must be appropriate for EMC applications. Refer to the Wiring and Grounding Guide, (PWM) AC Drives manual (publication [DRIVES-IN001](#)) for detailed information.

3 Install the EMC Plate For Frame A...C

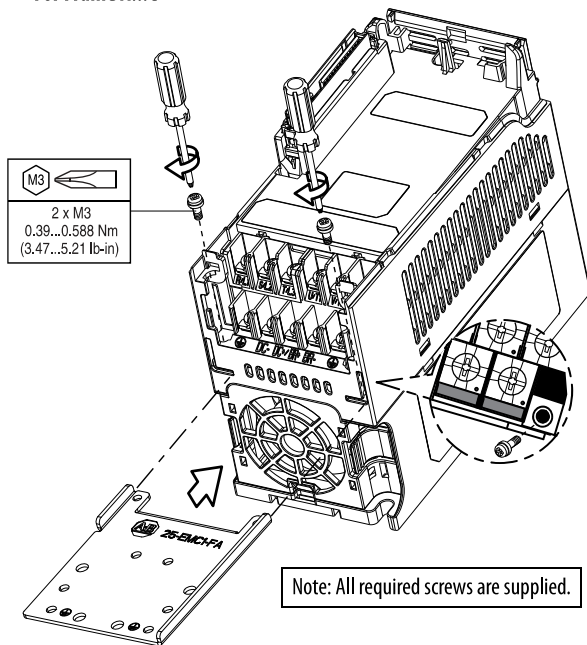

4 Install Wire Retaining Clips and Grounding Screws For Frame A...C

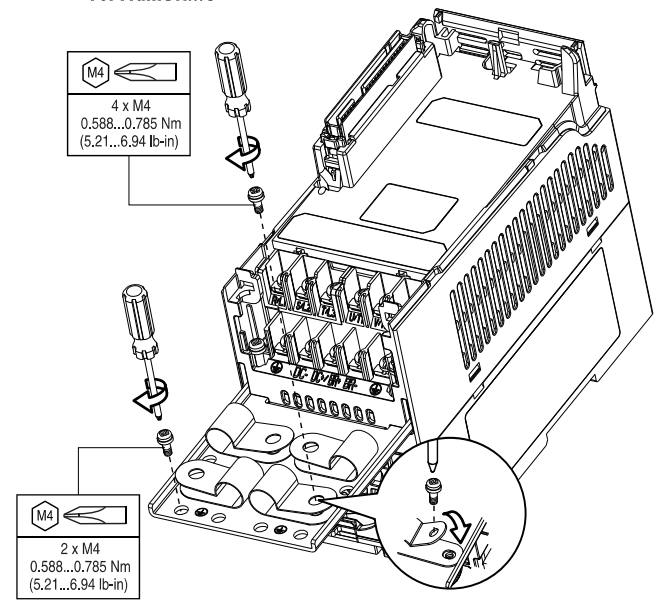

**3 Install the EMC Plate (continued)
For Frame D and E**

Note: EMC plate for Frame E attaches with M4 screws.

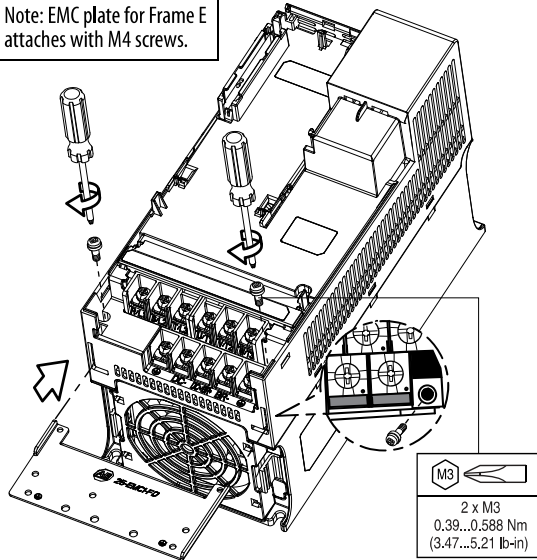

**4 Install Wire Retaining Clips and Grounding Screws (continued)
For Frame D and E**

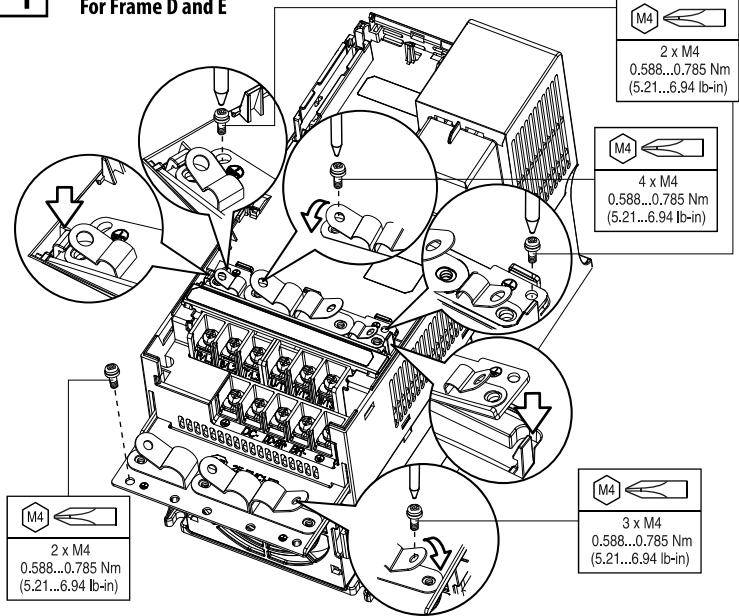

Wire Retaining Clip Layout

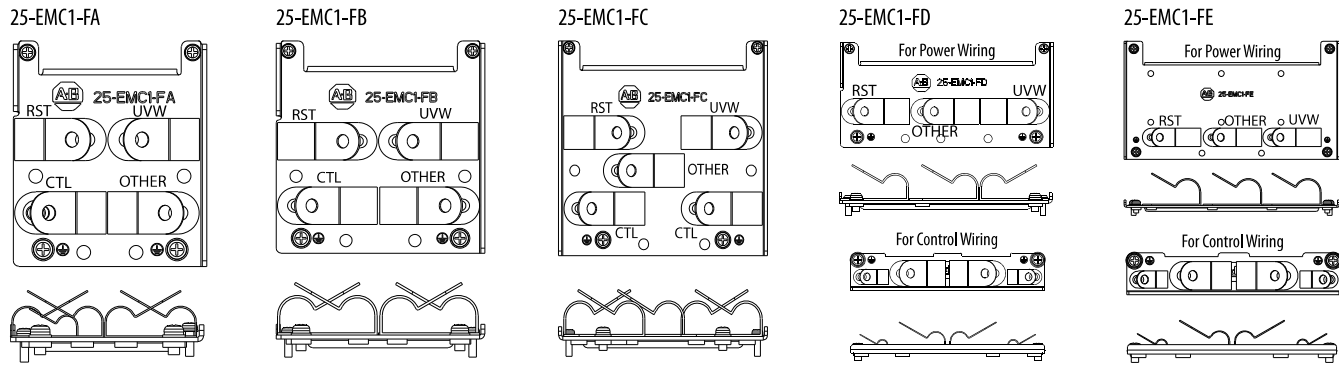

Dimensions

Frame	a	b	Plate 2 (a)	Plate 2 (b)
A	68.6 mm (2.70 in.)	80.0 mm (3.15 in.)	–	–
B	83.6 mm (3.29 in.)	85.0 mm (3.35 in.)	–	–
C	103.0 mm (4.06 in.)	96.0 mm (3.78 in.)	–	–
D	124.0 mm (4.88 in.)	61.0 mm (2.40 in.)	112.6 mm (4.43 in.)	22.0 mm (0.87 in.)
E	177.0 mm (6.97 in.)	97.0 mm (3.82 in.)	112.6 mm (4.43 in.)	22.0 mm (0.87 in.)

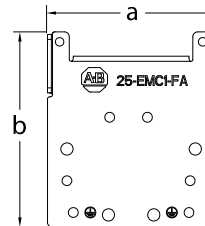

Recommended Wire Gauge

Frame	Wire Gauge
A	0.82...5.26 mm ² (18...10 AWG)
B	2.08...8.36 mm ² (14...8 AWG)
C	2.08...8.36 mm ² (14...8 AWG)
D	5.26...13.29 mm ² (10...6 AWG)
E	8.36...26.65 mm ² (8...3 AWG)

U.S. Allen-Bradley Drives Technical Support - Tel: (1) 262.512.8176, Fax: (1) 262.512.2222, E-mail: support@drives.ra.rockwell.com
Online: <http://www.ab.com/support/abdrives>

Allen-Bradley, Rockwell Software, Rockwell Automation, PowerFlex and TechConnect are trademarks of Rockwell Automation, Inc.
Trademarks not belonging to Rockwell Automation are property of their respective companies.

www.rockwellautomation.com

Power, Control and Information Solutions Headquarters

Americas: Rockwell Automation, 1201 South Second Street, Milwaukee, WI 53204-2496 USA, Tel: (1) 414.382.2000, Fax: (1) 414.382.4444
Europe/Middle East/Africa: Rockwell Automation NV, Pegasus Park, De Kleetlaan 12a, 1831 Diegem, Belgium, Tel: (32) 2 663 0600, Fax: (32) 2 663 0640
Asia Pacific: Rockwell Automation, Level 14, Core F, Cyberport 3, 100 Cyberport Road, Hong Kong, Tel: (852) 2887 4788, Fax: (852) 2508 1846