



# Instructions for Digitrip RMS 510 Trip Unit

Table of Contents	Page
1.0 General Description	1
1.1 Protection	1
1.2 Information	2
1.3 Testing	4
2.0 UL Listed Devices	4
3.0 Principle of Operation	4
3.1 General	4
3.2 Trip and Operation Indicators	5
3.3 Test Provisions	5
3.4 Discriminator (Making Current Release)	5
3.5 OVERRIDE (Fixed Instantaneous)	6
3.6 Zone Interlocking	6
4.0 Protection Settings	6
4.1 General	6
4.2 Long Delay Current Settings	7
4.3 Long Delay Time Settings	7
4.4 Short Delay Current Settings	8
4.5 Short Delay Time Settings	8
4.6 Instantaneous Current Settings	8
4.7 NO Instantaneous Current Settings	8
4.8 Ground Fault Current Settings	8
4.9 Ground Fault Time Delay Settings	9
5.0 Test Procedure	10
5.1 General	10
5.2 When To Test	11
5.3 Test Provision	11
5.4 Conducting Tests	11
5.4.1 Control Power	11
5.4.2 Not Tripping the Breaker	12
5.4.3 Tripping the Breaker	12
6.0 Battery (Inside the Rating Plug)	12
6.1 General	12
6.2 Battery Check	12
6.3 Battery Replacement	12
7.0 Auxiliary Power Module	14
8.0 Frame Ratings, (where applicable, Sensor Ratings) and Rating Plugs	14
9.0 References	15
9.1 Digitrip RMS Trip Assemblies	15
9.2 Type DS Low Voltage AC Power Circuit Breakers	15
9.3 Type SPB Systems Pow-R Breakers	15
9.4 Series C® R-Frame Molded Case Circuit Breakers	15
Appendix A Zone Interlocking - Example	15



## WARNING

**DO NOT ATTEMPT TO INSTALL OR PERFORM MAINTENANCE ON EQUIPMENT WHILE IT IS ENERGIZED. DEATH OR SEVERE PERSONAL INJURY CAN RESULT FROM CONTACT WITH ENERGIZED EQUIPMENT. ALWAYS VERIFY THAT NO VOLTAGE IS PRESENT BEFORE PROCEEDING WITH THE TASK, AND ALWAYS FOLLOW GENERALLY ACCEPTED SAFETY PROCEDURES. CUTLER-HAMMER IS NOT LIABLE FOR THE MISAPPLICATION OR MISINSTALLATION OF ITS PRODUCTS.**

It is strongly urged that the user observe all recommendations, warnings and cautions relating to the safety of personnel and equipment, as well as general and local health and safety laws, codes, and procedures.

The recommendations and information contained herein are based on experience and judgment, but should not be considered to be all-inclusive or covering every application or circumstance which may arise. If you have any questions or need further information or instructions, please contact your local representative, or the Customer Support Center for the type of circuit breaker you have:

Circuit Breaker Type	Call Telephone Number	Send to FAX Number
DS/DSL SPB	1 800 446 4082	
Series C® R-Frame		

## 1.0 GENERAL DESCRIPTION

### 1.1 Protection

The Digitrip RMS 510, illustrated in Fig. 1, is a custom application specific integrated circuit based trip unit suitable for use in types DS and DSL low voltage AC power circuit breakers and type SPB Systems Pow-R circuit breakers and Series C® R-Frame molded case circuit breakers.

The Digitrip RMS 510 provides true RMS current sensing for proper correlation with thermal characteristics of conductors and equipment. Interchangeable rating plugs are provided to establish the continuous current rating of each circuit breaker.

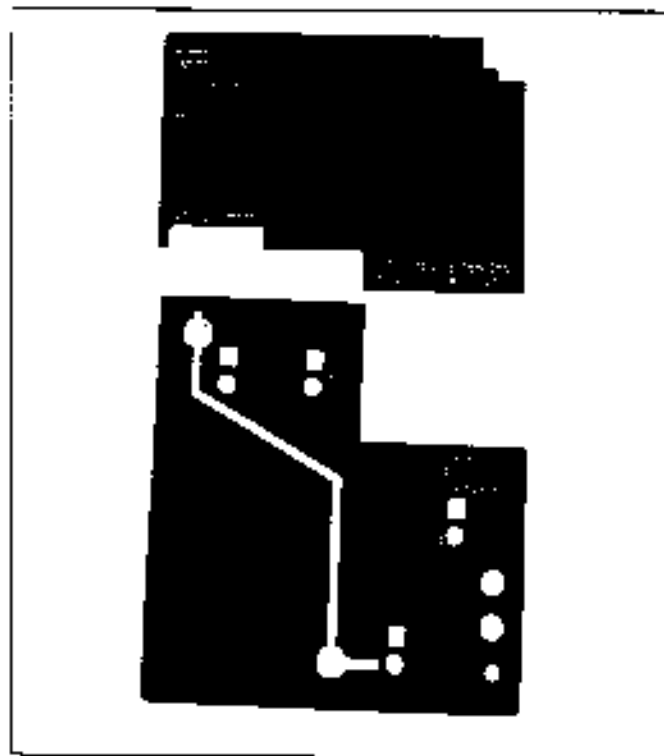

Fig. 2.1 Long Time/Instantaneous Protection (LI)

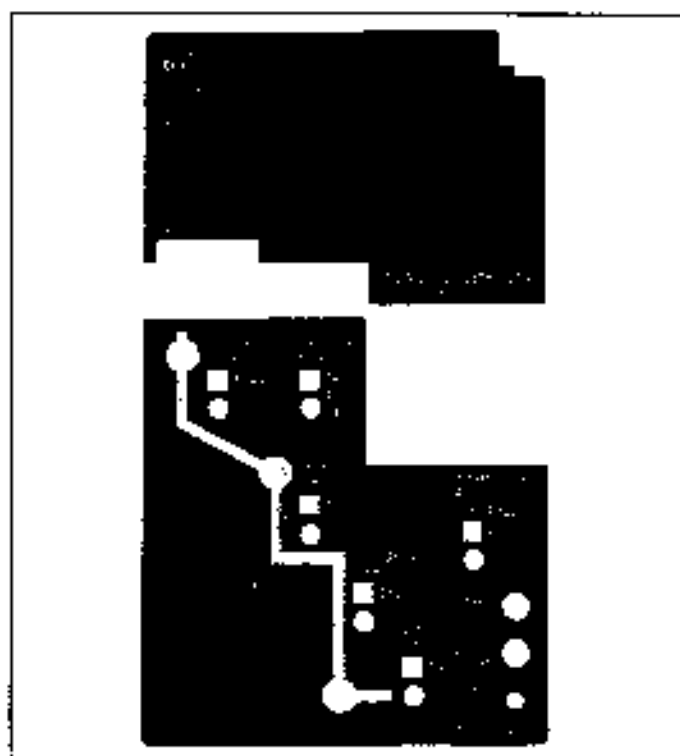

Fig. 2.3 Long Time/Short Time/Instantaneous Protection (LSI)

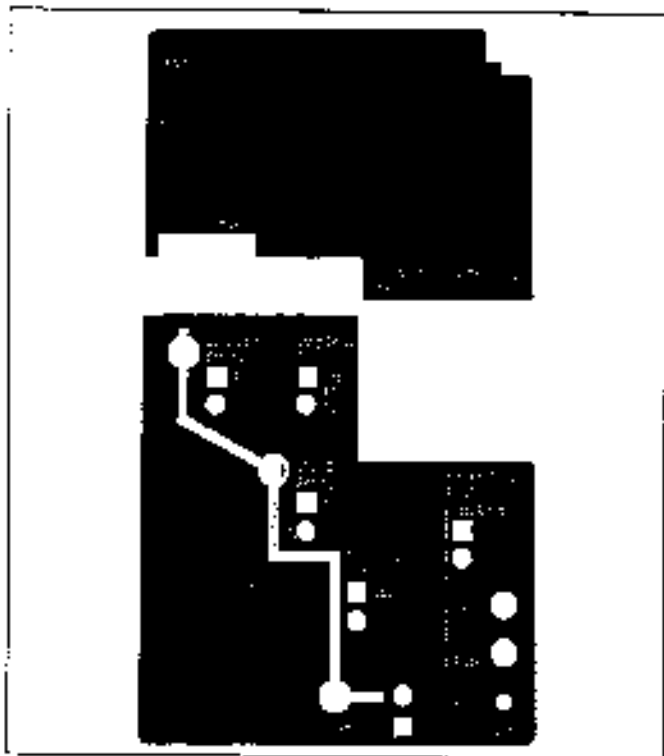

Fig. 2.2 Long Time/Short Time Protection (LS)

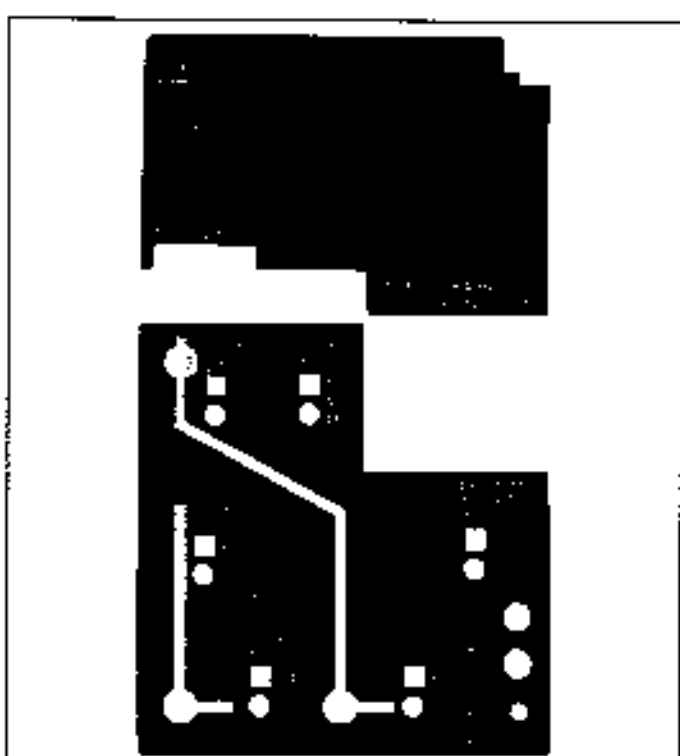

Fig. 2.4 Long Time/Instantaneous/Ground Protection (LIG)

the APM it may appear as if the trip unit does not respond until the current is well-above the set value, leading the tester to believe there is an error in the trip unit when there is none. The reason this occurs is that the single phase test current is not a good simulation of the normal three phase circuit. If three phase current had been flowing, the trip unit would actually have performed correctly. Use the APM for correct trip unit performance whenever single phase tests are made.

Plug in the Auxiliary Power Module (Cat. No. PRTAAPM) to insure control power is available for testing. When the APM is properly connected the "GREEN" Unit Status LED will blink on and off about once per second.

#### 5.4.2 Not Tripping the Breaker

1. Place the "Test Amps" selector switch (See Fig. 5) in one of the six "No Trip" test settings, i.e., 1, 2, 3, 8, or 10,  $\times I_n$ , or GF.
2. Depress the (Black) "Test" pushbutton and release it - the test starts when the pushbutton is released.
3. Should any of the various protection settings be less than the selected "No Trip" test value, then the LED related to that function will turn on signifying successful completion of the test action. Note: During the long delay tests the Long Delay LED flashes "RED".
4. Reset the trip unit by depressing and releasing the "Trip Reset" pushbutton. All LEDs lighted by the "No Trip" test action should turn "OFF".

Should an actual overload or fault condition occur during an in-service, "No Trip Test" sequence, the protection function will override the test function, and the circuit breaker will trip automatically in accordance with the actual Time-Current settings.

**Note:** The "Trip Reset" pushbutton may be depressed at any time. However, should a test already be in progress, the test would be aborted.

A test initiated via the integral test panel may be aborted at any time by depressing the "Trip Reset" pushbutton.

#### 5.4.3 Tripping the Breaker

1. Make sure that the circuit breaker is carrying no current. (See CAUTION notes under Section 5.1.)

**NOTE:** In the event it is decided to perform a "Breaker Trip Test" while load current is flowing, make sure the circuit breaker is carrying no more than 50% of the Long Delay Current Setting  $I_r$ . (The

trip unit will not execute your instructions to Test itself, when the load current exceeds 50% of  $I_r$ .)

2. Place the "Test Amps" selector switch (See Fig. 5) in one of the two "Trip" test settings, i.e., 6T or GFT.
3. Depress the black "Test" pushbutton (See Fig. 5) and release it - the test is initiated when the pushbutton is released.
4. Should any of the various protection settings be less than the selected "Test Amps" value, the circuit breaker will trip and the LED related to that function will light "RED".
5. Reset the trip unit by depressing and releasing the "Trip Reset" pushbutton (See Fig. 5). All LEDs lighted by the "Trip" test action should turn "OFF".

## 6.0 BATTERY (INSIDE THE RATING PLUG)

### 6.1 General

The battery has no part in the protection function of the trip unit.

As indicated in Figs. 3 and 6, the battery is provided to maintain the "RED" LED indication of the cause of TRIP in the Digitrip RMS 510 Trip Unit. The battery is located in the rating plug along with a battery check pushbutton and a green battery check LED.

### 6.2 Battery Check

The battery is a long life, lithium photo type unit. The status of the battery can be checked at any time by depressing the battery check pushbutton and observing the "GREEN" LED as shown in Fig. 6. If the battery check LED does not light "GREEN", replace the battery. The condition of the battery has no effect on the protection function of the trip unit. Even with the battery removed, the unit will still trip the breaker in accordance with its settings. However, without the battery, the cause of TRIP LED will not be lighted "RED". If the battery is replaced (or if an Auxiliary Power Module is plugged into the trip unit), one or more of the cause of Trip LED's may be illuminated. The user should push the red "TRIP RESET" button to turn off the indications, and the trip unit will be ready to indicate the next cause of trip.

### 6.3 Battery Replacement

The battery can be easily replaced from the front of the trip unit by lowering the hinged cover of the rating plug as shown in Fig. 6. The battery can then be removed by pulling the battery tab as shown in Fig. 6.

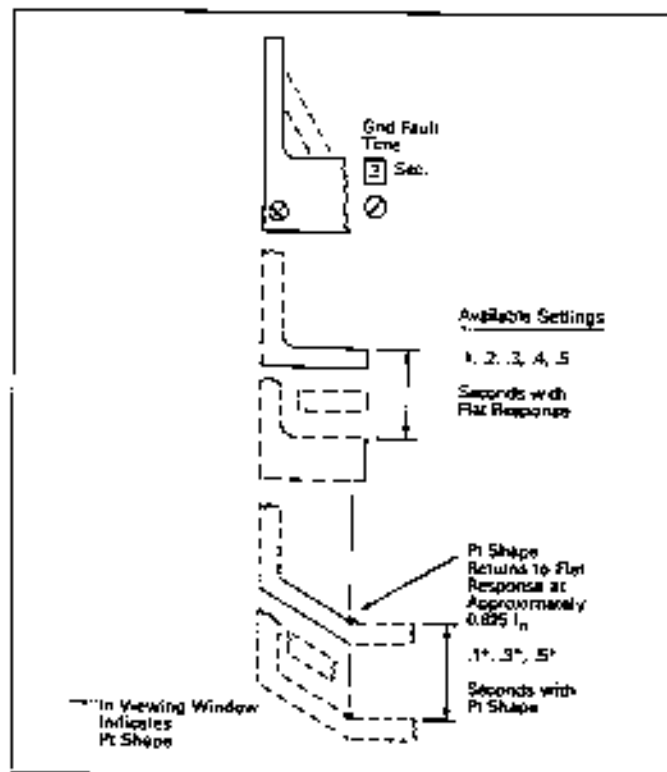

Fig. 4.7 Ground Fault Time Delay Settings

Note: See also Section 3.6 on Zone Interlocking.

## 5.0 TEST PROCEDURES

### 5.1 General



## DANGER

**DO NOT ATTEMPT TO INSTALL, TEST OR PERFORM MAINTENANCE ON EQUIPMENT WHILE IT IS ENERGIZED. DEATH OR SEVERE PERSONAL INJURY CAN RESULT FROM CONTACT WITH ENERGIZED EQUIPMENT.**

**DE-ENERGIZE THE CIRCUIT AND DISCONNECT THE CIRCUIT BREAKER BEFORE PERFORMING MAINTENANCE OR TESTS.**

As illustrated in Figs. 1 and 5, an integral test panel is provided to test the Digitrip RMS 510 Trip Unit.

Several no-trip settings are provided to check the trip unit operation without actually tripping the circuit breaker.

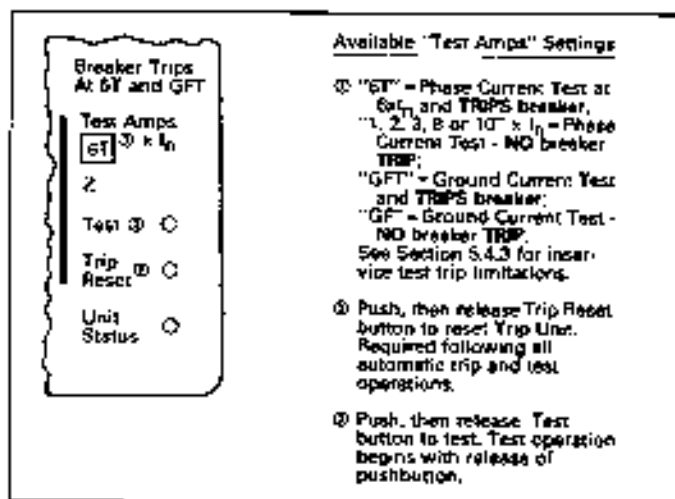

Fig. 5 Integral Test Panel (Lower Right Corner of Trip Unit)



## CAUTION

**TESTING A CIRCUIT BREAKER UNDER "TRIP CONDITIONS" WHILE IT IS IN SERVICE AND CARRYING LOAD CURRENT, WHETHER DONE BY INTERNAL OR EXTERNAL MEANS, IS NOT RECOMMENDED.**

**ANY TRIPPING OPERATION WILL CAUSE DISRUPTION OF SERVICE AND POSSIBLE PERSONAL INJURY RESULTING FROM UNNECESSARY SWITCHING OF CONNECTED EQUIPMENT.**

**TESTING OF A CIRCUIT BREAKER THAT RESULTS IN THE TRIPPING OF THE CIRCUIT BREAKER SHOULD BE DONE ONLY WITH THE CIRCUIT BREAKER IN THE "TEST" OR "DISCONNECTED" CELL POSITIONS OR WHILE THE CIRCUIT BREAKER IS ON A TEST BENCH.**

To preserve the primary protection function of the trip unit, all in-service testing under "Trip" or "No-Trip" conditions are only performed at load current values no greater than 50% of the Long Delay Current Setting,  $I_n$ . Any attempt to conduct in-service testing when the load current exceeds 50% of  $I_n$  will not be executed by the trip unit.

Since the Digitrip RMS 510 Trip Unit is completely self-powered using energy derived from the current sensors installed in the circuit breaker, all in-service tests conducted should be conducted with the auxiliary control power module, shown in Fig. 7, plugged into the trip unit. This action will avoid difficulties caused by load current levels that are too low to operate the trip unit.

LDT will reset itself. You can of course, manually clear the LDT (or any other trip indication) at any time, by pushing the "PUSH TO RESET" button. (See Figure 1.)

#### 4.4 Short Delay Current Setting

There are eight (8) available Short Delay Current Settings, as illustrated in Fig. 4.3. Six settings are in the range from 2 to 6 times  $I_r$  and the other two settings are "S1" or "S2" times  $I_r$ . (REMEMBER:  $I_r$  is the Long Delay Current Setting). The values that "S1" and "S2" have depend upon the type of circuit breaker, and are specified both on the rating plug label (see Fig. 6), and on the applicable Time-Current Curves referenced in Section 9.0.

#### 4.5 Short Delay Time Setting

As illustrated in Fig. 4.4, there are two different Short Delay curve shapes, i.e., fixed time (flat) or  $I^2t$  response. The shape selected depends on the type of selective coordination chosen. The  $I^2t$  response will provide a longer time delay in the low-end of the short delay current range than will the flat response.

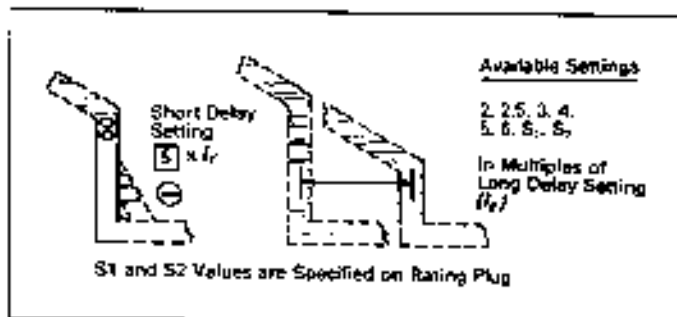

Fig. 4.3 Short Delay Current Settings

Five flat (.1, .2, .3, .4, .5 sec.) and three  $I^2t$  (.1\*, .3\*, .5\* sec.) response time delay settings are available. The  $I^2t$  response settings are identified by the suffix asterisk (\*) that appears in the viewing window. The  $I^2t$  response is applicable to currents less than eight (8) times  $I_r$ , the Long Delay Setting. For currents greater than 8 times  $I_r$ , the  $I^2t$  response reverts to the flat response.

**Note:** See also Section 3.6, Zone Interlocking, above.

#### 4.6 Instantaneous Current Setting

There are eight (8) available Instantaneous Current Settings, as illustrated in Fig. 4.5. Six settings are in the range from 2 to 6 times ( $I_n$ ) the rating plug value, and the

other two settings are "M1" or "M2" times ( $I_n$ ). The values that "M1" and "M2" have depend upon the type of circuit breaker, and are specified both on the rating plug label (see Fig. 6), and on the applicable Time-Current Curves referenced in Section 9.0.

#### 4.7 NO Instantaneous Current Setting

For types LS and LSG trip units, please see Sections 3.4 DIScriminator (Making Current Release) and 3.5 OVER-RIDE (Fixed Instantaneous), for available fast-acting high short-circuit protection.

#### 4.8 Ground Fault Current Setting

The eight (8) Ground Fault Current Settings are labeled with the code letters "A" through "K" (except there are no "G" or "I" settings), as illustrated in Fig. 4.6. In general, the specific current settings range from 0.25 to 1.0 times ( $I_n$ ), the rating plug value, but cannot exceed 1200 A. The specific Ground Current Settings for each letter are listed in Table 1 and on the applicable Time-Current curve for the breaker.

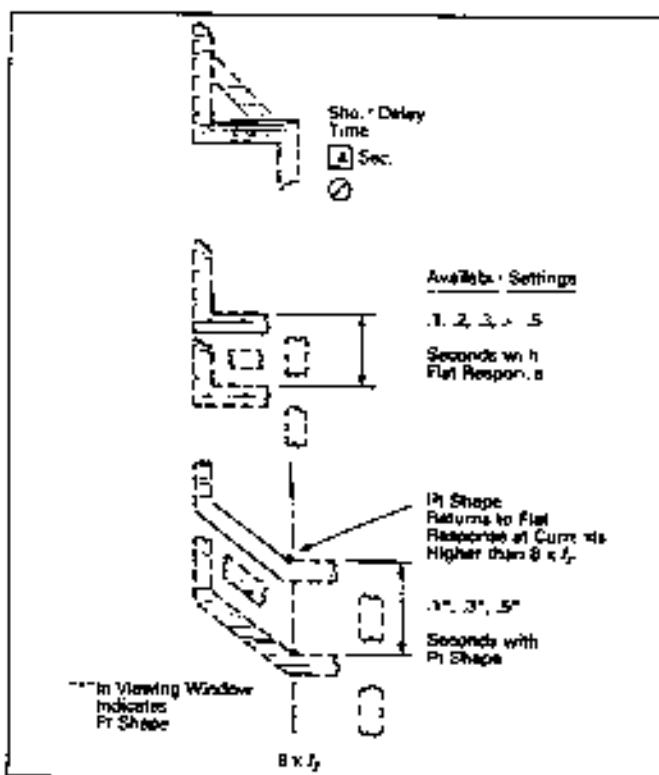

Fig. 4.4 Short Delay Time Settings

**Notes:**

- 1 This switch has eight (8) positions, and seven (7) of them show "DIS" in the window, while ONLY ONE position shows "[BLANK]".
- 2 When the "OVERRIDE" window shows "[BLANK]", the only fast-acting high short-circuit protection available is the OVERRIDE [Fixed Instantaneous]. (See 3.5 below.)

### 3.5 OVERRIDE (Fixed Instantaneous) (For Types LS And LSG Trip Units Only)

When the Digitrip RMS 510 Trip Unit is not equipped with an adjustable instantaneous setting, i.e., types LS or LSG, the Fixed Instantaneous "Override" analog trip circuit is automatically pre-set to a value no greater than the short-time withstand current rating of the circuit breaker in which the trip unit is installed. Since the specific values vary for different circuit breaker types and ratings, refer to time-current curves, listed in Section 9, for the values applicable to your breaker. If breaker trips due to high instantaneous current, the "OVERRIDE" LED will light "RED".

### 3.6 Zone Interlocking

Zone Selective Interlocking (or Zone Interlocking) is available (see Fig. 3) for Digitrip RMS Trip Units having Short Delay and/or Ground Fault protection. Zone Selective Interlocking provides the fastest possible tripping for faults within the breaker's zone of protection, and yet also provides positive coordination among all breakers in the system (mains, ties, feeders and downstream breakers) to limit the outage to the affected part of the system only. When Zone Interlocking is enabled, a fault within the breaker's zone of protection will cause the RMS DIG-ITRIP trip unit to:

- a) Trip the affected breaker instantaneously, and at the same time
- b) Send a signal to upstream RMS DIGITRIP trip units to restrain from tripping immediately. The restraining signal causes the upstream breakers to follow their set coordination times, so that only the minimum service is disrupted, while the fault is cleared in the shortest time possible.

(This signal requires only a single pair of wires from the output terminals of the downstream breaker's trip unit to the input terminals of the upstream breaker's trip unit. For specific instructions see the applicable connection diagrams for your breaker listed in Section 9.0.)

Note: If a breaker (M) receives a Zone Interlocking signal from another breaker (F), but the fault current level is less than the trip unit setting for breaker (M), the signal from the other breaker (F) will not cause breaker (M) to trip.



## CAUTION

**IF ZONE INTERLOCKING IS NOT TO BE USED (I.E. STANDARD TIME-DELAY COORDINATION ONLY IS INTENDED), THE ZONE INTERLOCKING TERMINALS MUST BE CONNECTED WITH JUMPER WIRES, AS SPECIFIED ON THE CONNECTION DIAGRAMS FOR YOUR BREAKER (SEE SECTION 9.0), SO THE TIME-DELAY SETTINGS WILL PROVIDE THE INTENDED COORDINATION.**

For an example of how Zone Selective Interlocking may be used, See Appendix A.

## 4.0 PROTECTION SETTINGS

### 4.1 General

Prior to placing circuit breaker in operation, each trip unit protection setting must be set to the values specified by the engineer responsible for the installation. The number of settings that must be made is determined by the protector model supplied as illustrated in Figs. 2.1 through 2.6. Each setting is made with a rotary switch, using a small screwdriver. The selected setting for each adjustment appears in its respective rectangular viewing window as illustrated in Fig. 1.

The installed rating plug establishes the maximum continuous current rating of the circuit breaker ( $I_n$ ). Instantaneous and ground current settings are defined in multiples of ( $I_n$ ).

To illustrate the effect of each protection curve setting, simulated Time-Current curves are pictured on the face of the trip unit. The rotary switch to make each setting is located nearest that portion of the simulated Time-Current curve it controls. Should an automatic "trip" occur (as a result of the current exceeding the pre-selected value), the LED in the appropriate segment of the simulated Time-Current curve will light "RED" indicating the reason for "trip".

The available settings, along with the illustrated effect of changing the settings, are given in Figs. 4.1 through 4.7.

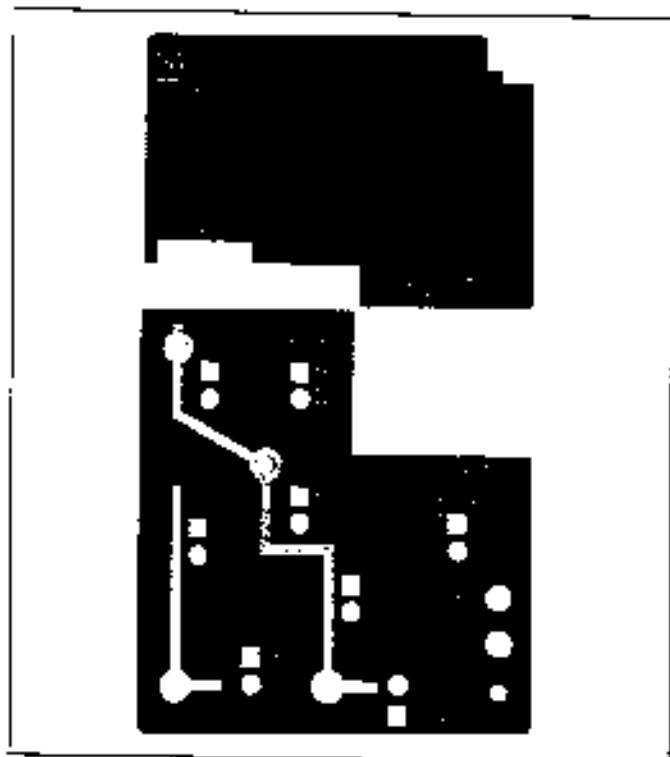

Fig. 2.5 Long Time/Short Time/Ground/Protection (LSG)

### 1.3 Testing

To test the trip unit, use the integral test panel. (See Section 5.0.)

### 2.0 UL LISTED DEVICES

Digitrip RMS 510 Trip Units are "Listed" by the Underwriters Laboratories, Inc.® Under UL File E7819, for use in types DS, DSL, SPB and Series C® R-Frame circuit breakers.

### 3.0 PRINCIPLES OF OPERATION

#### 3.1 General

The Digitrip RMS 510 trip unit is designed for use in industrial circuit breaker environments where the ambient temperatures can range from  $-20\text{ C}$  to  $+85\text{ C}$  and rarely exceed  $70$  to  $75\text{ C}$ . If, however, temperatures in the neighborhood of the trip unit do exceed this range, the trip unit performance may be degraded. In order to insure that the tripping function is not compromised due to an over-temperature condition, the Digitrip RMS 510 microcomputer chip has a built-in over-temperature protection feature, factory set to trip the breaker if the chip temperature exceeds  $95\text{ C}$ . If over-temperature is the reason for the trip, the Long Delay Time LED will light "RED".

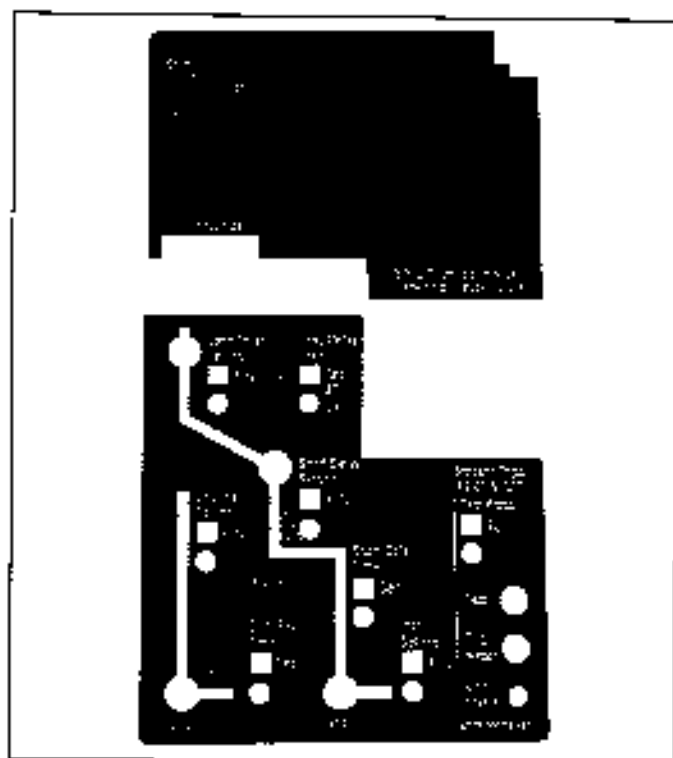

Fig. 2.6 Long Time/Short Time/Instantaneous/Ground Protection (LSIG)

The Digitrip RMS 510 Trip unit provides three basic functions: Protection, Information and Testing. A typical trip unit and rating plug are illustrated in Fig. 1. Individual product instruction leaflets referenced in Section 9.0 illustrate typical Digitrip RMS Trip Units installed in specific breakers.

The trip unit employs the Cutler-Hammer Inc. custom designed integrated circuit  $\$4\mu\text{RE} +$  chip, which includes a microcomputer to perform its numeric and logic functions. The principle of operation is described by the block diagram shown in Fig. 3.

In the Digitrip RMS 510 Trip Unit, all required sensing and tripping power to operate its protection function is derived from the current sensors in the circuit breaker. The secondary currents from these sensors provide the correct input information for the protection functions, as well as tripping power, whenever the circuit breaker is carrying current. These current signals develop analog voltages across the appropriate calibrating resistors including:

- 1) Phase currents
- 2) Ground current (when supplied)
- 3) Rating plug

The resulting analog voltages are digitized by the custom designed integrated circuits.

The Digitrip RMS 510 Trip Unit is completely self-contained and when the circuit breaker is closed, requires no external control power to operate its protection systems. It operates from current signal levels and control power derived through current sensors integrally mounted in the circuit breaker.

The Digitrip RMS 510 Trip Unit is available in six different types. Each trip unit may be equipped with a maximum of five phase and two ground (time-current) adjustments to meet specific application requirements. The types of protection available for each model include the following, which are illustrated in Figures 2.1 through 2.6:

Protection	Types	Refer to Figure
Long Time/Instantaneous	LI*	2.1
Long Time/Short Time	LS*	2.2
Long Time/Short Time/Instantaneous	LSI*	2.3
Long Time/Instantaneous/Ground	LIG	2.4
Long Time/Short Time/Ground	LSG	2.5
Long Time/Short Time/Instantaneous/ Ground	LSIG	2.6

**Note:** RMS Digitrip Type LI, LS, and LSI trip units can be applied on 3-pole or 4-pole circuit breakers for protection of the neutral circuit, *IF the circuit breaker is wired and MARKED for NEUTRAL PROTECTION.* Refer to the National Electric Code for appropriate application of 4-pole breakers.

## 1.2 Information

Light Emitting Diodes (LED's) on the face of the trip unit light "Red" to indicate the reason for an automatic trip operation. The battery in the rating plug maintains the reason for trip indication following an automatic trip operation, until the "TRIP RESET" button is pushed.

The "Green" LED in the lower right corner "blinks" to indicate the trip unit is operating normally. The battery in the rating plug is "OK" if the LED lights "Green" when the "battery check" button next to it is pushed. (See Section 6.)

**Note:** The Digitrip RMS 510 provides all of its protection functions regardless of the status of the battery. The battery serves only to maintain the indication of the reason for automatic trip.

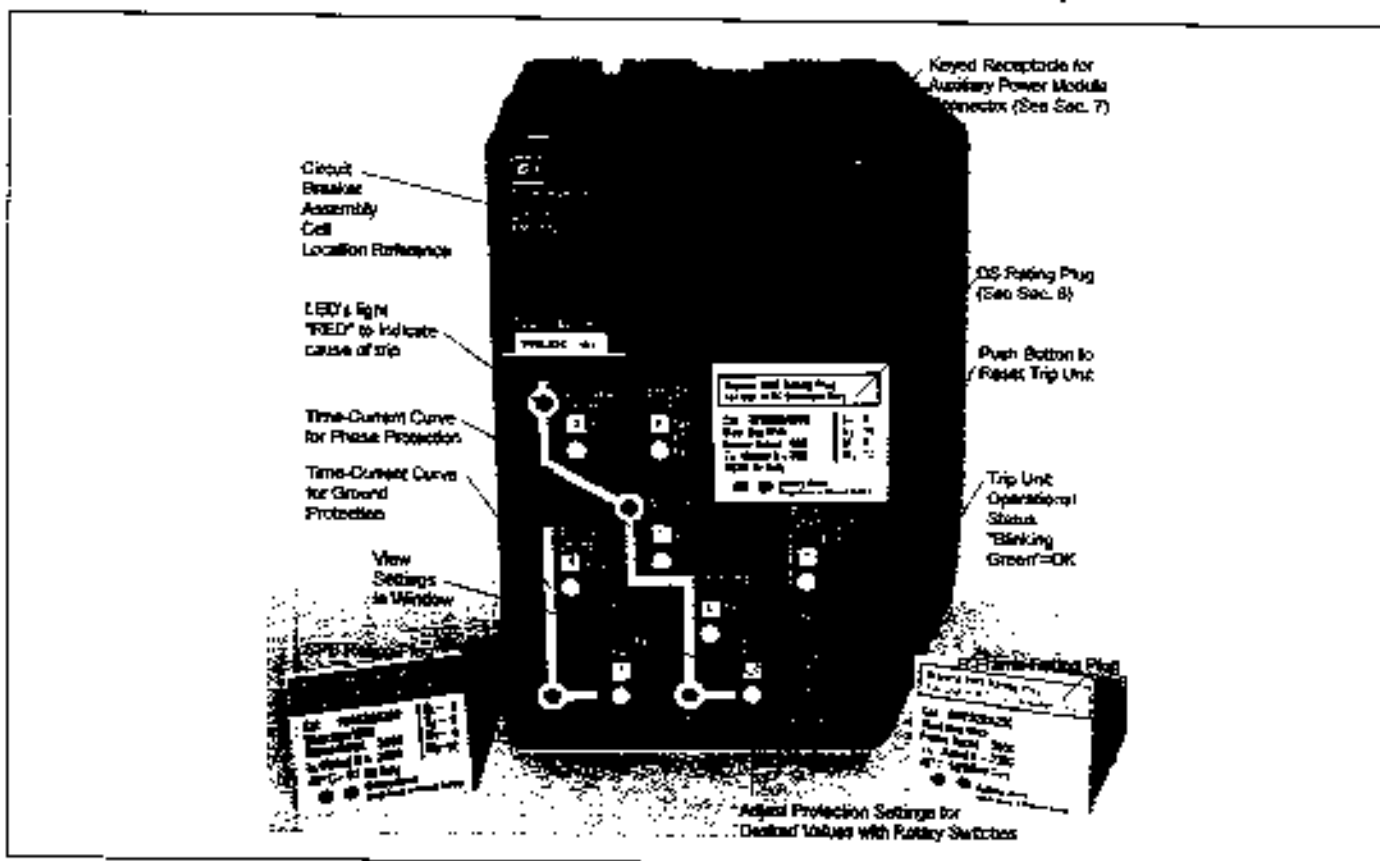

Fig. 1 Digitrip RMS 510 Trip Unit Model LSiG with Rating Plug



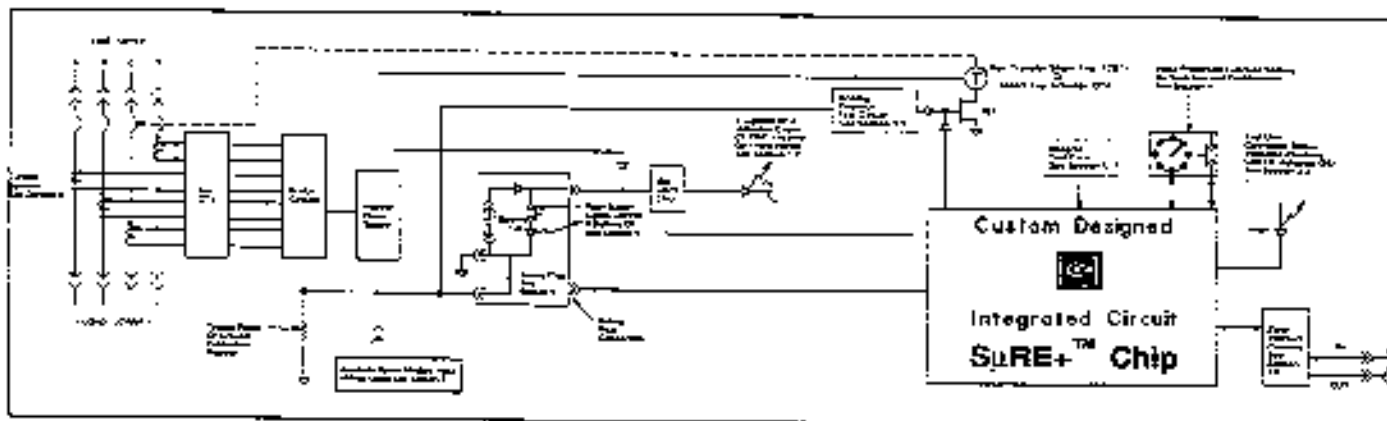

Fig. 3 Digitrip RMS 510 Block Diagram with Breaker Interface

The microcomputer, in cyclic fashion, repeatedly scans the voltage values across each calibrating resistor and enters these values into its Random Access Memory (RAM). These data are used to calculate true RMS current values, which are then repeatedly compared with the protection function settings and other operating data stored in the Read Only Memory (ROM). The software program then determines whether to initiate protection functions, including tripping the breaker through the low energy trip device (Flux Transfer Shunt Trip or Direct Trip Actuator) in the circuit breaker.

### 3.2 Trip and Operation Indicators

The LEDs, shown in Figs. 1 and 2.1-2.6, on the face of the trip unit, light "RED" to indicate the reason for any automatic trip operation. As indicated in Figs. 2.1-2.6, each LED is strategically located in the related segment of the time-current curve depicted on the face of the trip unit. The reason for trip is identified by the segment of the time-current curve where the LED is lighted "RED". Following an automatic trip operation, the back-up battery, continues to supply power to the LEDs as indicated in Figs. 3 and 6. To check the status of the battery, see Section 6.

Push the "Trip Reset" button shown in Fig. 1, to turn "Off" the LEDs following a trip operation.

A green colored LED, as shown in Fig. 1, indicates the operational status of the trip unit. Once the load current through the circuit breaker exceeds approximately 10% of the frame/current sensor rating, the green LED will flash "On" and "Off" once each second, to indicate the trip unit is energized and operating properly.

**Note:** If the LED is steadily "GREEN", i.e. not flashing, the trip unit is not ready.

### 3.3 Test Provisions (See Section 5.0)

### 3.4 DIScriminator (Making Current Release)

(For Types LS and LSG trip units only.)

When the Digitrip RMS 510 Trip Unit is not equipped with an adjustable instantaneous protection setting, i.e., types LS or LSG, a making current release (or DIScriminator) circuit is provided. This circuit will prevent the circuit breaker from being closed and latched-in on a faulted circuit. The non-adjustable release is pre-set at eleven (11) times the installed rating plug current ( $I_n$ ).

The making current release is enabled only for the first ten (10) cycles following an initial circuit breaker closing operation, provided the load current exceeds approximately 10% of the circuit breaker frame (or current sensor) rating. Should the load current through the circuit breaker drop to less than the 10% value, the release will reset. The release, once reset, will remain enabled until the load current passing through the circuit breaker has exceeded the 10% value for 10 cycles. The making current release will trip the circuit breaker instantaneously.

In the event the breaker is intended to close (but not to trip out again) into a circuit whose current could initially be higher than  $11 \times I_n$ , it is possible to make the DIScriminator inactive. If the breaker does close onto a fully rated fault current, when the DIScriminator is inactive, the breaker will wait for the full short-time delay setting before it trips. The DIScriminator (making current release) can be made inactive by turning the "OVERRIDE" setting switch (nearest the bottom edge of the trip unit) from the "DIS" position, to the "[BLANK]" position. (See Figs. 2.2 and 2.5.)

#### 4.2 Long Delay Current Setting

There are eight (8) available Long Delay Settings, as illustrated in Fig. 4.1. Each setting, called " $I_r$ " is expressed as a multiple (ranging from .5 to 1) of the rating plug current ( $I_n$ ).

**Note:** " $I_r$ " is also the basis for the Short-Delay Current Setting. (See Section 4.4.)

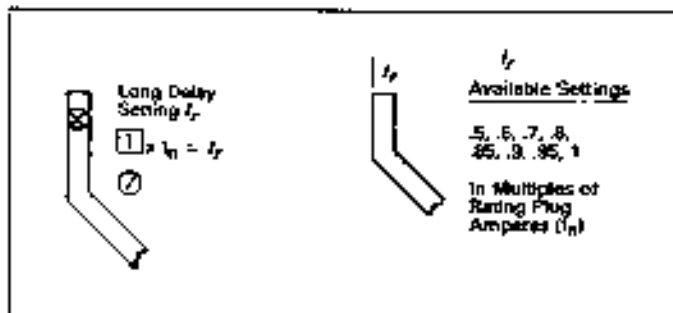

Fig. 4.1 Long Delay Current Settings

#### 4.3 Long Delay Time Setting

There are eight (8) available Long Delay Time Settings, as illustrated in Fig. 4.2, ranging from 2 to 24 seconds. These settings are the total clearing times when the current value equals six (6) times  $I_r$ .

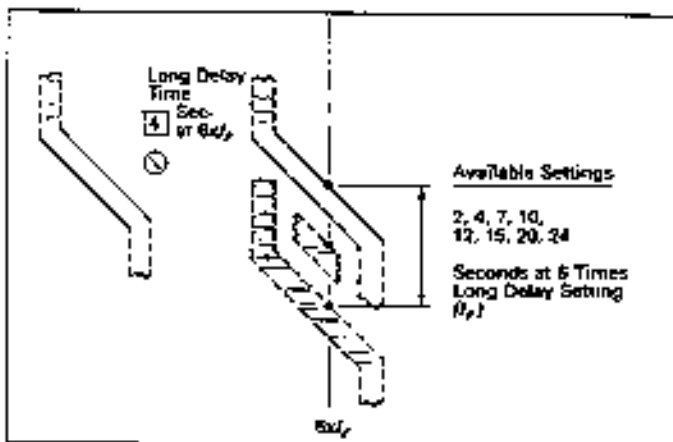

Fig. 4.2 Long Delay Time Settings

#### Notes:

- 1) In addition to the standard Long Delay Protection Element, the Digitrip RMS 510 trip unit also has a Long Time Memory function (LTM), which serves to protect load circuits from the effects of repeated overload conditions. If a breaker is reclosed soon after a Long Delay Trip, and the current again exceeds the Long Delay Setting,  $I_r$ , the LTM automatically reduces the time to trip, to

allow for the fact that the load circuit temperature is already higher than normal, due to the prior overload condition. Each time an overload condition is repeated, the LTM causes the breaker to trip in a time progressively earlier than the "Long Delay Time Setting". When the load current returns to normal, the LTM begins to reset; and after about 10 minutes it has reset fully, so that next Long Delay trip time will again be the "Setting" value.

In certain applications it may be desirable to disable the LTM function. The LTM function can be disabled by (first opening the breaker and then) removing the Rating Plug (See Figures 1 and 6), and lastly moving the LTM jumper (inside the rating plug cavity, See figure 4.2.1) to its "INACTIVE" connection. (You can enable the LTM function again any time you wish by moving the LTM jumper back to its original "ACTIVE" connection.)

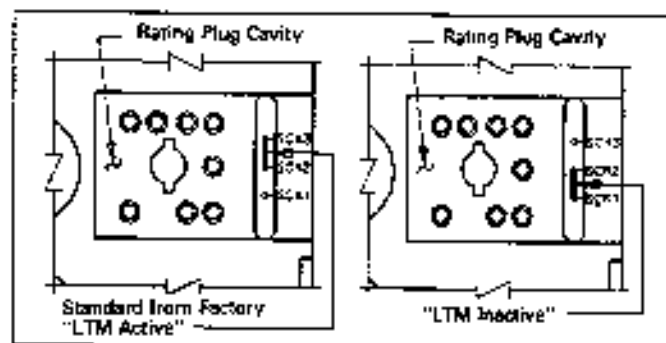

Fig. 4.2.1 Long Time Memory "LTM" Jumper

The action of the LTM is a factor to consider in performing multiple Long Delay Time tests. (See Section 5.4.)

- 2) There is a condition under which the Long Delay Trip LED can erroneously indicate a LDT has occurred, even though the breaker is still closed. This can happen when an overload current momentarily exceeds the Long Delay Current Setting,  $I_r$ , so that the Long Delay LED flashes "RED" to indicate the overload condition. Then if, at the very moment when the LED is "ON", the load current would then suddenly drop to a value less than 10% of the breaker frame (or current sensor) rating, the trip unit stops functioning while the "4bit Latch Chip" (See Fig. 3) is set and the LED remains Lighted. If the current would again increase to a value above the Long Delay Current Setting,  $I_r$ , and then return to normal, the

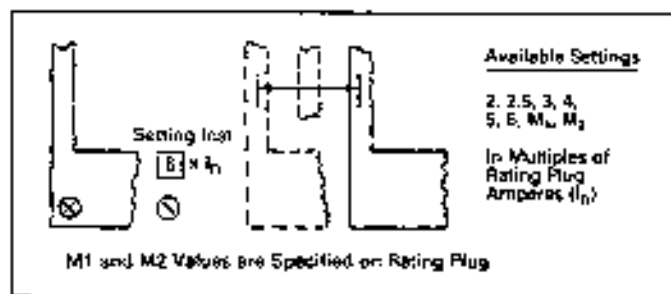

Fig. 4.5 Instantaneous Current Settings

**Note: For Testing Purposes Only:** When using an external single phase current source to test low level ground fault current settings, it is advisable to use the Auxiliary Power Module (APM) (See Fig. 7). Especially when the single phase current is low, without the APM it may appear as if the trip unit does not respond until the current is well above the set value, leading the tester to believe there is an error in the trip unit when there is none. The reason this occurs is that the single phase test current is not a good simulation of the normal three phase circuit. If three phase current had been flowing, the trip unit would actually have performed correctly. Use the APM for correct trip unit performance whenever single phase tests are made.

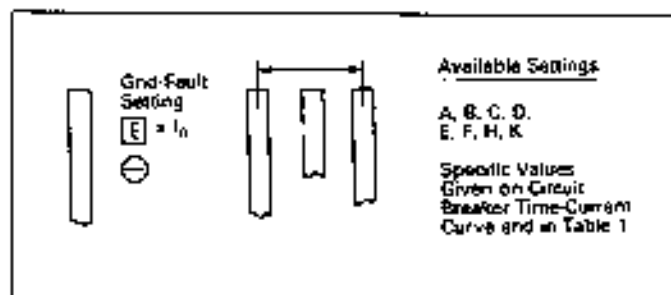

Fig. 4.6 Ground Fault Current Settings

TABLE 1 - GROUND FAULT CURRENT SETTINGS									
GROUND FAULT CURRENT SETTINGS (AMPERES) <sup>1</sup>									
	A	B	C	D	E	F	H	K	
INSTALLED RATING PLUG (AMPERES) I <sub>n</sub>	100	25	30	36	40	50	60	75	100
	200	50	60	70	80	100	120	150	200
	250	63	75	88	100	125	150	188	250
	300	75	90	105	120	150	180	225	300
	400	100	120	140	160	200	240	300	400
	600	150	180	210	240	300	360	450	600
	650	158	188	221	242	315	378	473	630
	800	200	240	280	320	400	480	600	800
	1000	250	300	350	400	500	600	750	1000
	1200	300	360	420	480	600	720	900	1200
	1750	412	495	588	670	838	1005	1268	1690
	1600	400	480	560	640	800	960	1200	1600
	2000	500	600	700	800	1000	1200	1500	2000
	2400	600	720	840	960	1200	1440	1800	2400
	2500	625	750	875	1000	1250	1500	1875	2500
	3000/1800	750	900	1050	1200	1500	1800	2250	3000
3200	800	960	1120	1280	1600	1920	2400	3200	
4000	1000	1200	1400	1600	2000	2400	3000	4000	
6000	1500	1800	2100	2400	3000	3600	4500	6000	

- ① Tolerances on settings are  $\pm 10\%$  of values shown.  
 ② Refer to Type DS, type SPB or Series C R-Frame supplemental instruction leaflets given in Section 9 for list of available rating plugs for each type circuit breaker.

#### 4.9 Ground Fault Time Delay Setting

As illustrated in Fig. 4.7, there are two different Ground Fault curve shapes, i.e., fixed time (flat) or  $I^2t$  response. The shape selected depends on the type of selective coordination chosen. The  $I^2t$  response will provide a longer time delay in the low-end of the ground fault current range than will the flat response.

Five flat (.1, .2, .3, .4, .5 sec.) and three  $I^2t$  (.1\*, .3\*, .5\* sec.) response time delay settings are available. The  $I^2t$  response settings are identified by the suffix asterisk (\*) that appears in the setting viewing window. The  $I^2t$  response is applicable to currents less than 0.625 times the ampere rating of the installed rating plug ( $I_n$ ). For currents greater than  $0.625 \times I_n$  the  $I^2t$  response reverts to the flat response.

## 5.2 When To Test

Tests can be conducted with the breaker in the "connected" cell position while carrying load current. However, as stated in the caution note in Section 5.1, good practice will limit circuit breaker in-service "trip tests", where required, to maintenance periods during times of minimum load conditions. Testing, prior to start-up can best be accomplished with the breaker out of its cell or in the "Test", "Disconnected" or "Withdrawn" (or Removed) cell positions.

**Note:** Since time-current settings are based on desired system coordination and protection schemes, the protection settings selected and preset in accordance with Section 4.8 above should not be altered during or as a part of any routine test sequence.

## 5.3 Test Provision

As indicated in Fig. 5, six different "Test Amps" settings (1, 2, 3, 6T, 8 and 10X  $I_n$ ) are available for testing the phase elements of the trip unit, and two (GF, GFT) are provided for testing the ground elements.



## CAUTION

**A SETTING OF EITHER 6T OR GFT WILL TRIP THE CIRCUIT BREAKER. (SEE SECTION 5.4.3 BELOW.)**

For any combination of the phase protection settings, an appropriate "No Trip" condition can be set to test the long time, short time and instantaneous trip settings without tripping the circuit breaker.

In the "GF" test position, the level of test current based on  $I_n$  is adequate to demonstrate the operating condition of the trip unit without tripping the circuit breaker. This is a functional check only, not a calibration.

## 5.4 Conducting Tests

- 1) *Before starting any test sequence, check the Unit Status (Green LED) in the lower right corner of the trip unit (See Figs. 1 and 5) to be sure it is blinking on and off about once each second, which indicates that the trip unit is functioning normally. In the event the Unit Status LED is not blinking, install an Auxiliary Power Module (APM) (See Fig. 7), or if you have one already, check to see that it is connected correctly.*
- 2) *If the circuit breaker is carrying current, check for the following conditions:*

- a) *the current is not less than 10% of the breaker frame (or current sensor) rating; be sure the "GREEN" Unit Status LED (in the lower right corner of the trip unit (See Figs. 1 and 5) is blinking on and off (indicating that there is enough current flowing to provide the power necessary to operate the trip unit). In the event the Unit Status LED is either lighted "GREEN" or "OFF" continuously, there is NOT enough current flowing to power the trip unit; and an APM (See Fig. 7) should be installed before proceeding with the test.*
- and b) *the current is not more than 50% of the Long Delay Current Setting ( $I_p$ ); because the trip unit will not execute your test instructions when it senses that the current through the breaker exceeds the 50% level.*

- 3) *When performing tests on the Long Delay element, be aware that in addition to the standard protection element, the Digitrip RMS 510 Trip Unit also has a Long Time Memory function (LTM), which serves to protect load circuits from the effects of repeated overload conditions. (See NOTE 1 under Section 4.3 Long Delay Time Setting.) The action of the LTM will have the same effect of advancing the Long Delay Trip Time if multiple Long Delay Time tests are performed repeatedly - as one might do in making single phase tests on each pole of a breaker in succession, for example. If you have sufficient experience in performing tests with this kind of accelerated trip timing, you may be comfortable with the results of tests performed in quick succession. However, if there is any question, you may simply wait about ten (10) minutes after a Long Delay Trip for the LTM to reset, before you check the next pole.*

## 5.4.1 Control Power

For testing the trip unit, an optional Auxiliary Power Module (Cat. No. PRTAAPM) as shown in Fig. 7 is recommended. This Auxiliary Power Module, which operates from a separate 120 Vac supply, may be used when a drawout circuit breaker is in any of its four cell positions, i.e., "Connected", "Test", "Disconnected" and "Withdrawn" (or "Removed.")

**Note:** For Testing Purposes Only: When using an external single phase current source to test low level ground fault current settings, it is advisable to use the Auxiliary Power Module (APM) (See Fig. 7). Especially when the single phase current is low, without

Note: The battery can be replaced at any time, even while the circuit breaker is in service, without affecting the operation of the circuit breaker or its protection function.



**CAUTION**

CARE SHOULD BE EXERCISED WHEN REPLACING A BATTERY TO INSURE THAT THE CORRECT POLARITIES ARE OBSERVED. POLARITY MARKINGS ARE SHOWN ON THE RATING PLUG WHEN THE HINGED COVER IS OPEN AS INDICATED IN FIG. 6.

The replacement battery should be the same type or equivalent. Acceptable 3.0 volt lithium batteries may be

obtained from the following companies under their type designation indicated:

Company	Model
Varta Batteries, Inc. 150 Clarbroom Road Elmsford, N.Y. 10523	CR 1/3N
Duracell South Broadway Tarrytown, N.Y. 10591 (914) 591-7000	DL 1/3N
Sanyo Electric Inc. Battery Division 200 Riser Road Little Ferry, N.J. 07643	CR 1/3N

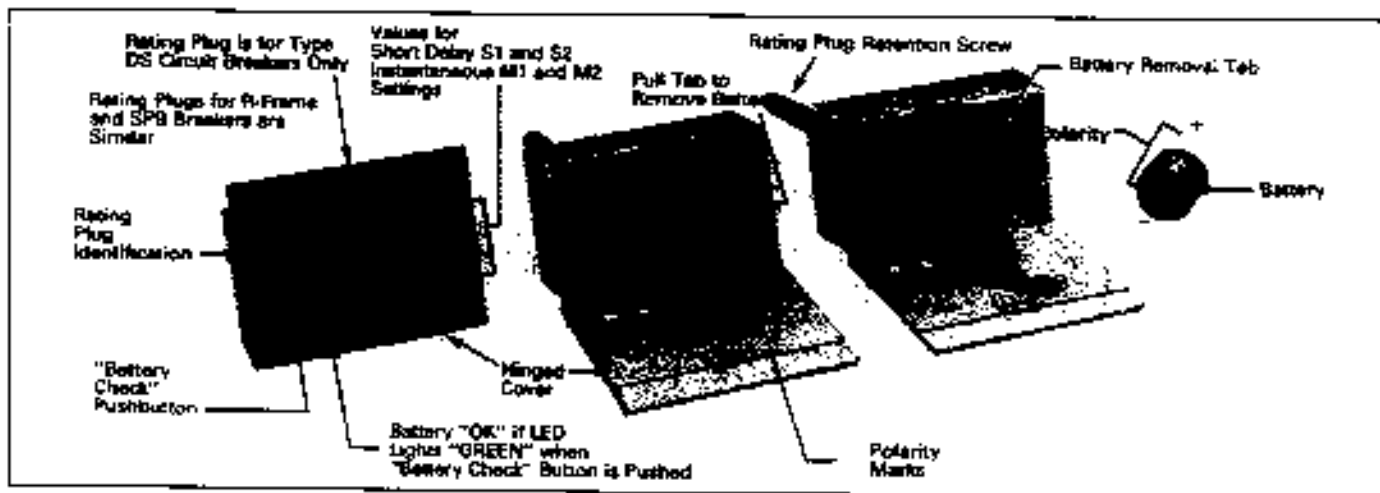

Fig. 6 Typical Rating Plug

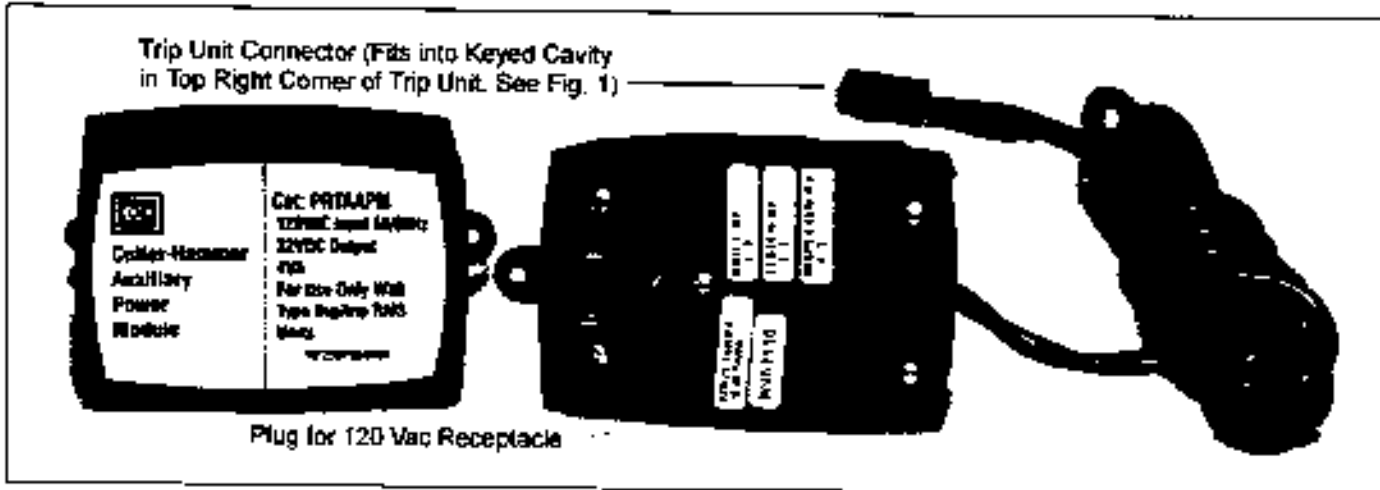

Fig. 7 Auxiliary Power Module

## 9.0 REFERENCES

## 9.1 Digitrip RMS Trip Assemblies

I.L. 29-885	Instructions for Digitrip RMS 510 Trip Unit
I.L. 29-886	Instructions for Digitrip RMS 610 Trip Unit
I.L. 29-888	Instructions for Digitrip RMS 810 Trip Unit

## 9.2 Type DS Low-Voltage AC Power Circuit Breakers

I.B. 33-790-1	Instructions for Low-Voltage Power Circuit Breakers Types DS and DSL
I.B. 33-790-1	Supplement B to Digitrip RMS Trip Units
AD 32-870	Typical Time-Current Characteristic Curves for Types DS and DSL Circuit Breakers
SC-5619-93	Instantaneous (I)
SC-5620-93	Long Delay and Short Delay (LS)
SC-5621-93	Ground (G)
508B508	Connection Diagram for Type DS Circuit Breakers

## 9.3 Type SPB Systems Pow-R Breakers

I.L. 29-801	Instruction for the Systems Pow-R Breaker and Drawout Mechanism
I.L. 29-849	Supplementary Instructions for the Systems Pow-R Breaker used with the Digitrip RMS Trip Units
AD 29-883	Typical Time-Current Characteristic Curves for Type SPB Systems Pow-R Breaker
SC-5623-93	Instantaneous (I)
SC-5624-93	Long Delay and Short Delay (LS)
SC-5625-93	Ground (G)
I.S. 15545	SPB Master Connection Diagram

9.4 Series C<sup>®</sup> R-Frame Molded Case Circuit Breakers

29C106	Frame Book
29C107	Frame Instruction Leaflet
29C713	Supplementary Instructions for Series C <sup>®</sup> R-Frame used with the Digitrip RMS Trip Units
AD 29-167R	Typical Time-Current Characteristic Curves for R-Frame Circuit Breakers
SC-5626-93	Instantaneous (I)
SC-5627-93	Long Delay and Short Delay (LS)
SC-5628-93	Ground (G)

I.L. 29C714	Master Connection Diagram for Series C <sup>®</sup> R-Frame Circuit Breaker
-------------	---

## APPENDIX A ZONE INTERLOCKING

Assume a ground fault of 2000 Amperes occurs and refer to Fig A.1.

**CASE 1: There is no Zone Selective Interlocking. (standard time delay coordination is used)**

Fault 3

The branch breaker will trip clearing the fault in 0.1 s.

Fault 2

The feeder breaker will trip clearing the fault in 0.3 s.

Fault 1

The breaker will trip clearing the fault in 0.5 s.

**CASE 2: There is Zone Selective Interlocking**

Fault 3

The branch breaker trip unit will initiate the trip in 0.03 s to clear the fault and Z3 will send an interlocking signal to the Z2 trip unit; and Z2 will send an interlocking signal to Z1.

Z1 and Z2 trip units will begin to time out, and in the event that the branch breaker Z3 would not clear the fault, the feeder breaker Z2 will clear the fault in 0.3 s (as above). Similarly, in the event that the feeder breaker Z2 would not clear the fault, the main breaker Z1 will clear the fault in 0.5 s (as above).

Fault 2

The feeder breaker trip unit will initiate the trip in 0.03 s to clear the fault; and Z2 will send an interlocking signal to the Z1 trip unit, Z1 trip unit will begin to time out, and in the event that the feeder breaker Z2 would not clear the fault, the main breaker Z1 will clear the fault in 0.5 s (as above).

Fault 1

There are no interlocking signals. The main breaker trip unit will initiate the trip in 0.03 s.

Figure A.2 presents a Zone Selective Interlocking connection diagram for a system with two main breakers from incoming sources and a bus tie breaker. Note the blocking diode D1 is needed so that the feeder breakers can send interlocking signals to both the main and tie breakers, without having the tie breaker send itself an interlocking signal.

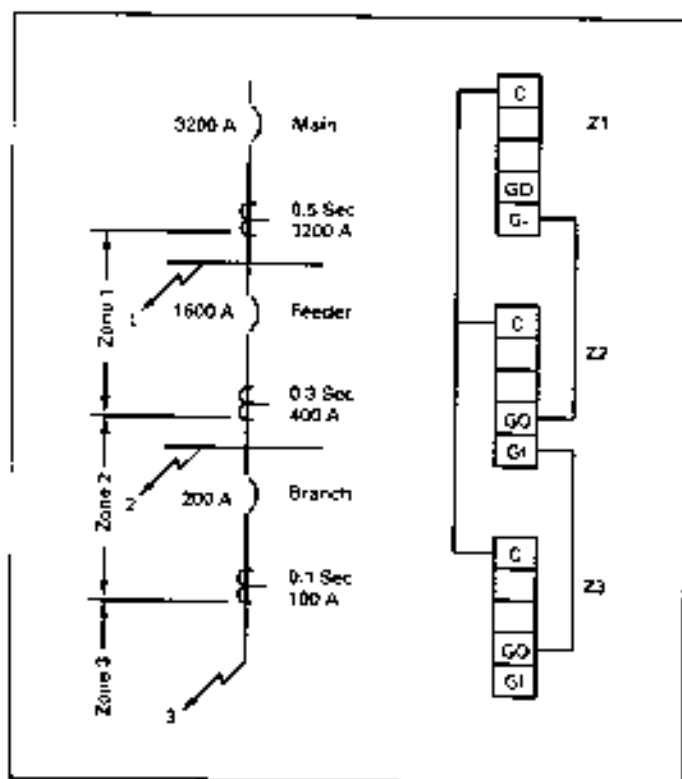

Fig. A.1 Typical Zone Interlocking (Ground Fault Protection)

Notes: A1: Wiring to be twisted pair of AWG No. 14 to AWG No. 20.

Route Zone Interlocking wiring separate from power conductors.

DO NOT GROUND any Zone Interlock Wiring.

A2: The maximum distance between first and last zone is 250 feet (76 m).

A3: A Maximum of 20 breakers may be connected in parallel in one Zone.

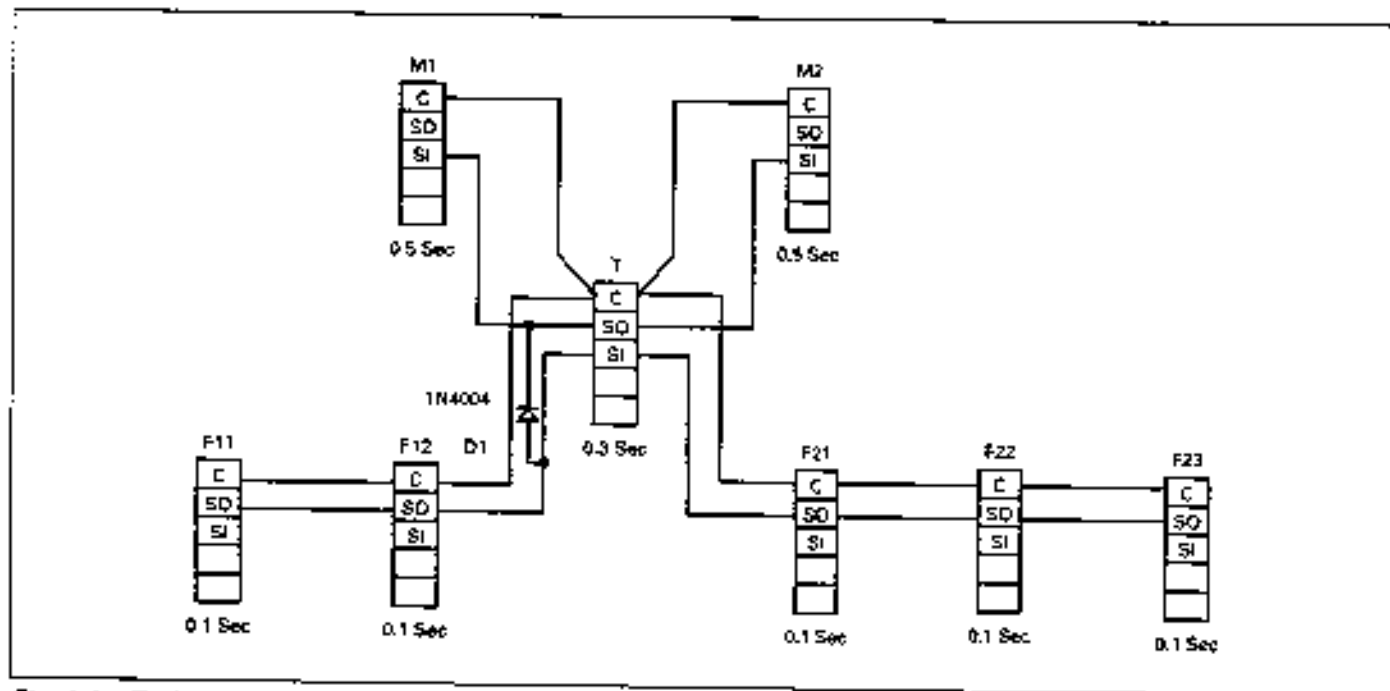
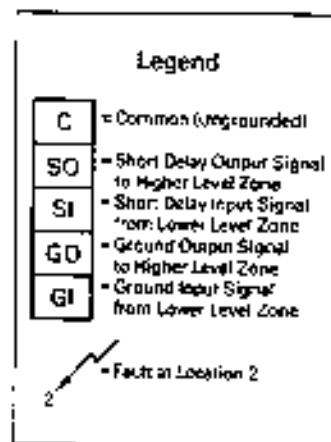

Fig. A.2 Typical Zone Interlocking Connections with Two Main Breakers (M1, M2) and a Tie Breaker (T) (Short Delay Protection)

## 7.0 AUXILIARY POWER MODULE

The Auxiliary Power Module or APM (Cat No. PRTAAPM), illustrated in Fig. 7, is an encapsulated power supply that requires a 120 Vac input at either 50 or 60 Hz. It provides an output of 32 Vdc (nominal 40 Vdc open circuit) which can be used for testing a Digitrip RMS 510 Trip Unit.

When a drawout circuit breaker is equipped with a Digitrip RMS 510 Trip Unit, it can be conveniently set and tested while the circuit breaker is out of its cell or in its cell in the "Test", "Disconnect" or "Withdrawn" positions by using the Auxiliary Power Module.

The Auxiliary Power Module is equipped with a unique plug-in connector suitable only for plugging into the keyed receptacle in the upper right corner of a Digitrip RMS Trip Unit as shown in Fig. 1. This prohibits the possible use of an incorrect type power module.

## 8.0 FRAME RATINGS, (WHERE APPLICABLE, SENSOR RATINGS) AND RATING PLUGS

The **Frame Rating** of a circuit breaker is the maximum RMS current it can carry continuously. The maximum Short-Circuit Current Rating of the Circuit breaker are usually related to the Frame Rating as well.

It is often times desirable to be able to choose a current value ( $I_n$ ), less than the full frame rating, to be the basis for the coordination of the circuit breaker's protection functions, without affecting its short-circuit current capability. For the Digitrip 510 trip unit this is implemented by changing the **Rating Plug** (and/or **Current Sensors**, where applicable - See your circuit breaker instructions (listed in Section 9.0 below) to determine if this applies to your circuit breaker).

The **(Current) Sensor Rating** (where applicable) is the maximum RMS current the circuit breaker can carry with the specified current sensors installed. The Sensor Rating can be the same or less than the Frame Rating, but not greater.

The **Rating Plug** (See Fig. 6) fits into a special cavity to complete the trip unit (See Fig. 1). Rating plugs have two current ratings listed on their covers (See Fig. 6):

- 1) the "Must be used with Frame Rated" cur-

rent value (or "Sensor Rated", if applicable).

- and 2) " $I_n$  (Rated I) =" current value.

This latter value, ( $I_n$ ) is the basis for the trip unit current settings:

- 1) The Instantaneous and Ground Current Settings (if provided) are multiples of ( $I_n$ ) (See Sections 4.6 and 4.8)
- 2) The Long Delay Current Setting,  $I_L$ , is a multiple of ( $I_n$ ). Long Delay Current Setting =  $I_L = LD \times (I_n)$ . (See Section 4.2)
- 3) The Short Delay Current Setting (if provided) is indirectly dependent upon ( $I_n$ ), because it is a multiple of  $I_n$  which in turn is a multiple of ( $I_n$ ).

$$\begin{aligned} \text{Short Delay Current Setting} &= SD \times I_L \\ &= SD \times LD \times (I_n). \end{aligned}$$

(See Section 4.4)

Rating Plugs for the Digitrip RMS 510 trip units are marked for and may be applied on both 50 and 60 Hz systems.



## CAUTION

**BEFORE YOU FIT THE RATING PLUG INTO THE TRIP UNIT, BE SURE TO CHECK THAT THE BREAKER TYPE AND FRAME RATING (OR SENSOR RATING IF APPLICABLE), MATCH THOSE PRINTED ON THE RATING PLUG COVER. INSTALLING A RATING PLUG THAT DOES NOT MATCH THE BREAKER TYPE AND FRAME RATING (OR SENSOR RATING, IF APPLICABLE), CAN PRODUCE SERIOUS MISCOORDINATION AND/OR FAILURE OF THE PROTECTION SYSTEM.**

Complete catalog descriptions of all available rating plugs are given in the applicable circuit breaker supplementary instruction leaflets. (See Section 9)

**Note: Rating plugs from Digitrip models 500/500/700/800 CAN NOT be used with model 510 trip units. The connection pins are located in different positions, so that one cannot accidentally use the incorrect kind of plug.**