

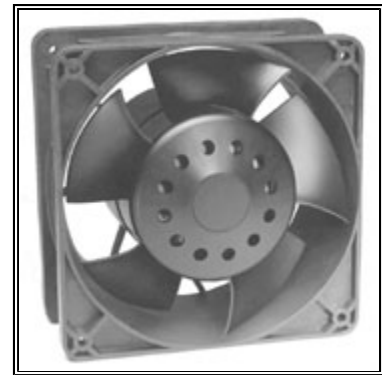

# Tarzan AC (AC Fan)

COMAIR ROTRON PART NUMBER: **020169**  
 COMAIR ROTRON MODEL NUMBER: **TNE2C**



MOTOR	
Rated Voltage:	115
Operating Voltage Range:	
Running Current: 50Hz   60Hz (amps)	0.53   0
Locked Rotor Current: (amps)	1.35
Rated Power: 50Hz   60Hz (watts)	56   0
Nominal Speed: 50Hz   60Hz (rpm)	3480   0

MECHANICAL	
Dimensions:	176mm x 112mm (6.91in x 4.40in)
Bearing Type:	Ball
Motor Base:	Plastic
Propeller:	Polycarbonate

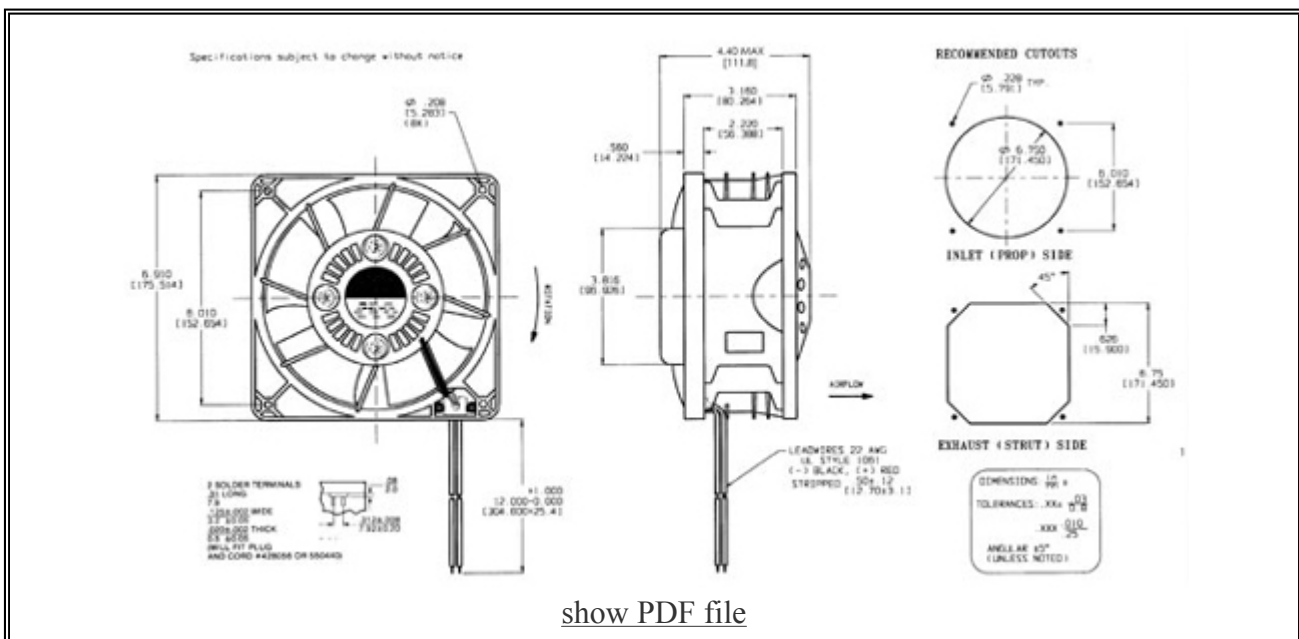



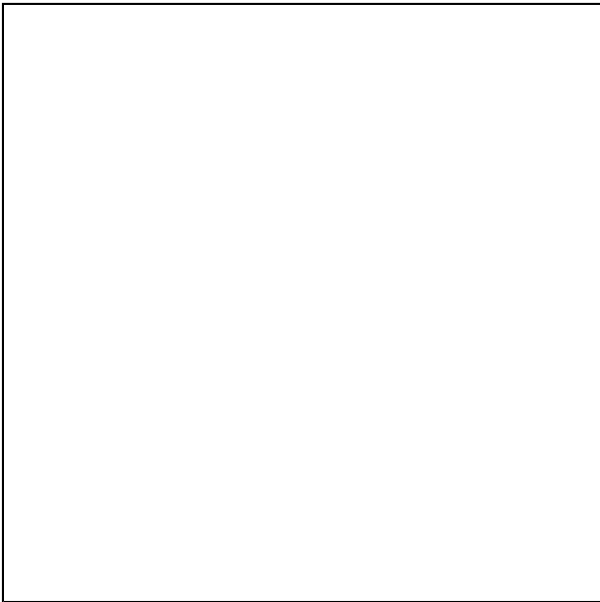

[show PDF file](#)

NOTES



PERFORMANCE CHARACTERISTICS	
Air Flow: (CFM)	280/330
Static Pressure:	.600/.785

TERMINATION	
Leadwires:	12" Leadwires

SAFETY			
			

All product names are used under license and are trademarks or registered trademarks of Comair Rotron, Inc.