

AJT

TIME DELAY / CLASS J



SMARTSPOT™ WITH MAXIMUM CIRCUIT PROTECTION

Amp-trap 2000® SmartSpot™ AJT fuses now provide a visual open fuse indicator. With advanced material technology added to the existing product line the AJT fuse provides IEC Type “2” (No Damage) protection to main, feeder, and branch circuits, for all types of loads — yet, they require only half the mounting space needed for 600VAC Class RK fuses. AJT’s time delay characteristics for handling harmless in-rush currents, its current limiting ability (the most current limiting UL fuse class!), and wide range of ratings (from 1 to 600 Amperes) — give excellent protection for all your applications.

Features/Benefits

- **Solid State SmartSpot Indicator**
- **Time delay** for motor starting and transformer inrush
- **300kA interrupting rating** - self-certified, UL witnessed tests
- **Extremely current limiting** for low peak let-thru current
- **Most current limiting UL class fuse**
- **Small footprint** requires less mounting space and allows smaller, more economical fuse blocks
- **Easy 2-to-1 selectivity** for prevention of nuisance shutdowns
- **Unique Class J dimensions** prevent replacement errors
- **High-visibility orange label** gives instant recognition
- **Metal-embossed date and catalog number** for traceability and lasting identification
- **Fiberglass body** provides dimensional stability in harsh industrial settings
- **High-grade silica filler** ensures fast arc quenching
- **Optional EI Indicator/Switch mount** for AJT70 to 600 open fuse indication

HIGHLIGHTS:

- Smart Spot Indicator
- Time Delay
- Highly Current Limiting
- DC Ratings
- Optional Mechanical Indicator (70 to 600A fuses)

APPLICATIONS:

- Motor Circuits
- Mains
- Feeders
- Branch Circuits
- Lighting, Heating & General Loads
- Transformers
- Control Panels
- Circuit Breaker Back-up
- Bus Duct
- Load Centers

Ratings

- **AC:** 1 to 600A
600VAC, 200kA I.R.
(self certified for 600VAC, 300kA I.R., UL witnessed)

DC: 1 to 600A
500VDC, 100kA I.R.

Approvals

AJT (1-600):

- UL Listed to Standard 248-8
- DC Listed to UL Standard 198L
- CSA Certified to Standard C22.2 No. 248.8
- IEC 269-2-1

AJT (70-600) EI:

- UL Component Recognized
- DC Tested to UL Standard 198L



TIME DELAY / CLASS J FUSES

AJT

Standard Fuse Ampere Ratings, Catalog Numbers

AMPERE RATING	CATALOG NUMBER	AMPERE RATING	CATALOG NUMBER	AMPERE RATING	CATALOG NUMBER	AMPERE RATING	CATALOG NUMBER
1	AJT1	4-1/2	AJT4-1/2	25	AJT25	125	AJT125
1-1/4	AJT1-1/4	5	AJT5	30	AJT30	150	AJT150
1-1/2	AJT1-1/2	5-6/10	AJT5-6/10	35	AJT35	75	AJT75
1-6/10	AJT1-6/10	6	AJT6	40	AJT40	200	AJT200
1-8/10	AJT1-8/10	6-1/4	AJT6-1/4	45	AJT45	225	AJT225
2	AJT2	7	AJT7	50	AJT50	250	AJT250
2-1/4	AJT2-1/4	8	AJT8	60	AJT60	300	AJT300
2-1/2	AJT2-1/2	9	AJT9	70	AJT70	350	AJT350
2-8/10	AJT2-8/10	10	AJT10	80	AJT80	400	AJT400
3	AJT3	12	AJT12	90	AJT90	450	AJT450
3-2/10	AJT3-2/10	15	AJT15	100	AJT100	500	AJT500
3-1/2	AJT3-1/2	17-1/2	AJT17-1/2	110	AJT110	600	AJT600
4	AJT4	20	AJT20				

Recommended Fuse Blocks With Box Connectors for Amp-trap® Class J Fuses

Fuse Ampere Rating	Catalog Number	
	600V OR LESS	
	1 Pole	3 pole
0-30	US3J1I	US3J3I
31-60	US6J1I	US6J3I
61-100	61036J	61038J
101-200	62001J	62003J
201-400	64031J	64033J
401-600	6631J	6633J

A variety of pole configurations and termination provisions is available.

Note: Indicator Not available (1-7a)

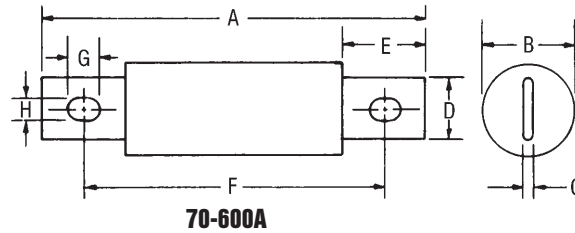
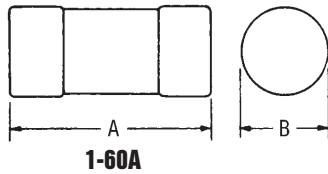

Dimensions

AMPERE RATING	A		B		C		D		E		F		G		H	
	In.	mm	In.	mm	In.	mm	In.	mm	In.	mm	In.	mm	In.	mm	In.	mm
1-30	2-1/4	57	13/16	21	-	-	-	-	-	-	-	-	-	-	-	-
31-60	2-3/8	60	1-1/16	27	-	-	-	-	-	-	-	-	-	-	-	-
61-100	4-5/8	117	1-1/16	27	1/8	3.2	3/4	19	1	25	3-5/8	92	3/8	10	9/32	7
101-200	5-3/4	146	1-5/8	41	3/16	4.8	1-1/8	29	1-3/8	35	4-3/8	111	3/8	10	9/32	7
201-400	7-1/8	181	2-1/8	54	1/4	6.3	1-5/8	41	1-7/8	48	5-1/4	133	17/32	14	13/32	10
401-600	8	203	2-1/2	64	3/8	9.5	2	51	2-1/8	54	6	152	11/16	18	17/32	13

Optional Indicator/Microswitch Mount (EI) dimensions:

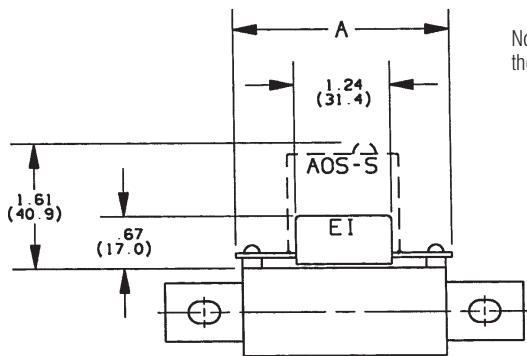

Note: Fuses with the EI option will receive the AOS-S or AOS-Q Add-On-Switch

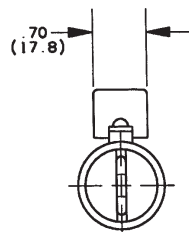

CATALOG NUMBER	A
AJT(70-100)-EI	2.80 (71.0)
AJT(110-200)-EI	3.22 (81.8)
AJT(225-400)-EI	3.24 (82.2)
AJT(450-600)-EI	3.61 (91.8)

TIME DELAY / CLASS J FUSES

AJT

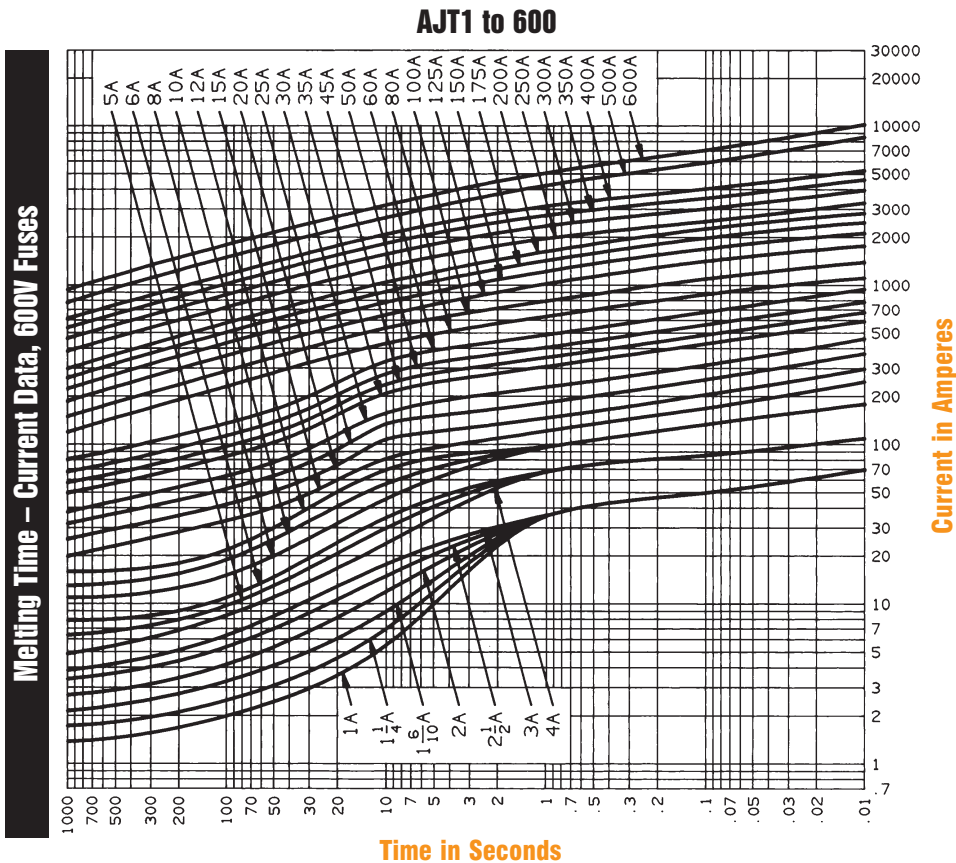

Peak Let-Through Current Data – AJT30 to 600, 600 Volts AC

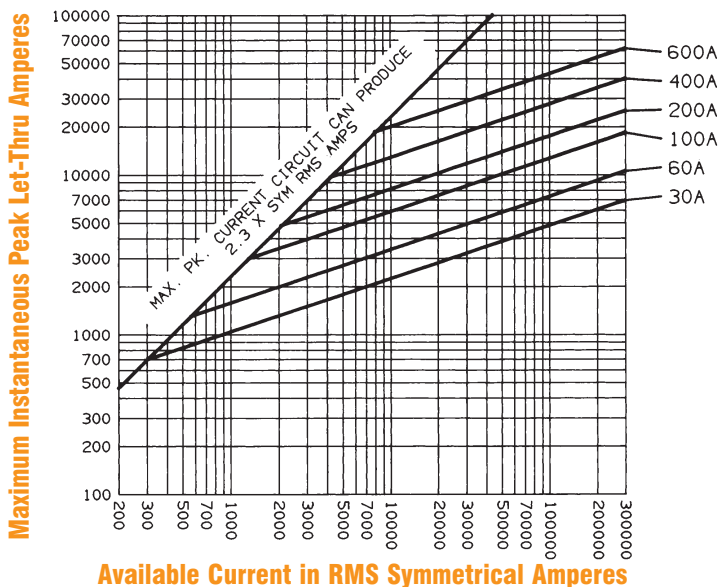

Note: See Application Tables page L9 for Three Phase Class J AJT Fuses.