



Instrument Transformers, Inc.

a division of GE Multilin



**Cross Reference to
Rockwell Part
Number 25645-009-06**

Current Transformer Model 8

Window Diameter 3.25"

REGULATORY AGENCY APPROVALS



E93779



LR89403

Manufactured to meet the requirements of ANSI/IEEE C57.13.
Classified by U.L. in accordance with IEC 44-1



APPLICATION:

Metering.

FREQUENCY:

50-400 Hz.

INSULATION LEVEL:

600 Volts, 10 kV BIL full wave.

Terminal are brass studs No. 8-32 with one flatwasher, lockwasher and regular nut.

Flexible leads are UL 1015, 105°C, CSA approved, #16 AWG, 24" long. Non-standard, lead length can be specified.

Model 8SHT also available as 8SHL with leads.

Order mounting bracket kit 0221B00183 separately for model 8SHT.

Order bus bar mounting kit 0221A26074 separately, factory installed.

Approximate weight 2.5 lbs.

CATALOG NUMBER	CURRENT RATIO	V.A. ± 1% CLASS	ANSI METERING CLASS AT 60HZ					SECONDARY WINDING RESISTANCE (OHMS @ 75°C)	CONTINUOUS THERMAL RATING FACTOR	
			B0.1	B0.2	B0.5	B0.9	B1.8		@ 30°C	@ 55°C
8**-201	200:5	5.0	1.2	1.2	2.4	4.8	4.8	0.030	2.0	2.0
8**-251	250:5*	7.5	0.6	0.6	1.2	2.4	4.8	0.044	2.0	2.0
8**-301	300:5*	15.0	0.6	0.6	1.2	2.4	2.4	0.049	2.0	2.0
8**-401	400:5*	25.0	0.3	0.3	0.6	1.2	2.4	0.079	2.0	1.5
8**-501	500:5*	35.0	0.3	0.3	0.6	0.6	1.2	0.102	2.0	1.5
8**-601	600:5*	50.0	0.3	0.3	0.6	0.6	1.2	0.147	1.5	1.33
8**-751	750:5*	50.0	0.3	0.3	0.6	0.6	1.2	0.184	1.5	1.0
8**-801	800:5*	60.0	0.3	0.3	0.3	0.6	0.6	0.197	1.5	1.0
8**-102	1000:5*	75.0	0.3	0.3	0.3	0.6	0.6	0.246	1.33	1.0
8**-122	1200:5*	75.0	0.3	0.3	0.3	0.3	0.6	0.169	1.5	1.0
8**-152	1500:5*	90.0	0.3	0.3	0.3	0.3	0.6	0.316	1.33	1.0
8**-162	1600:5*	100.0	0.3	0.3	0.3	0.3	0.6	0.337	1.33	0.8
8**-202	2000:5*	120.0	0.3	0.3	0.3	0.3	—	0.422	1.0	0.8
8**-252	2500:5*	50.0	0.3	0.3	0.3	0.3	—	0.438	1.0	0.8
8**-302	3000:5	60.0	0.3	0.3	0.3	0.3	—	0.526	1.0	0.8
8**-322	3200:5	70.0	0.3	0.3	0.3	0.3	—	0.561	1.0	0.8
8**-402	4000:5	80.0	0.3	0.3	0.3	0.3	—	0.973	0.8	0.8

**Note: When ordering, prefix Cat No. with model designation required i.e. 8SHT-201, 8RL-301, etc.

*Approved for revenue metering by Industry Canada No. T-188

Model 8

EXCITATION CURVE

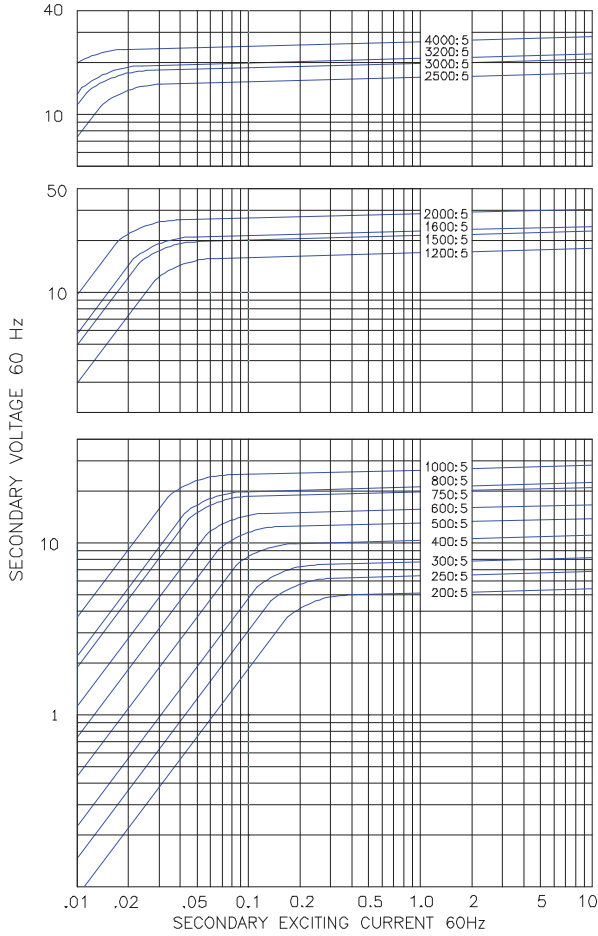

Model 8RL

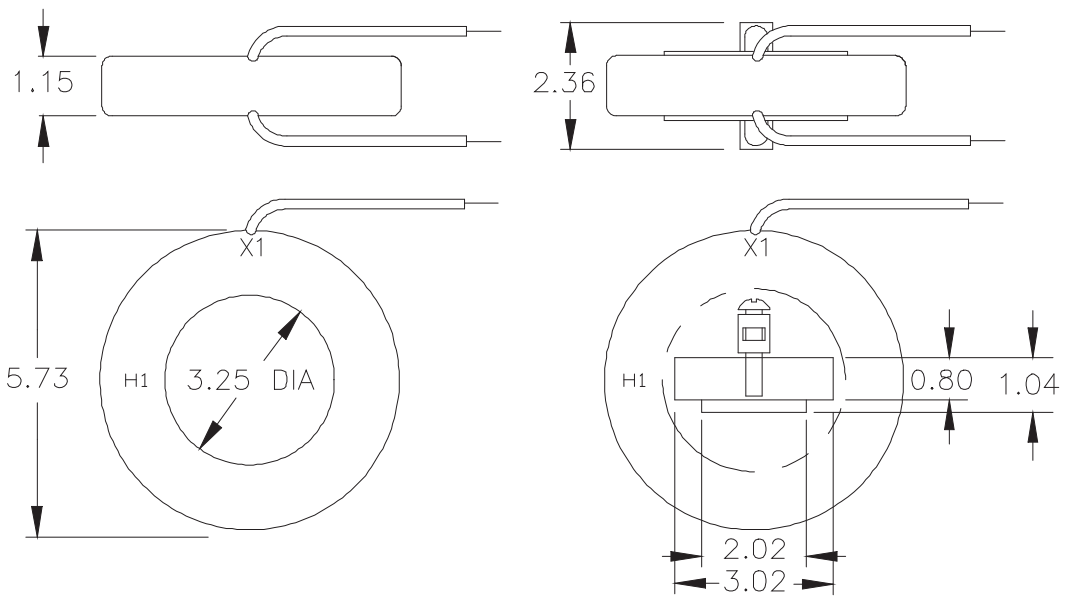

(BUS BAR MOUNTING
KIT SHOWN)

USA, Canada, Asia, Latin America

Tel: +1-800-547-8629

Fax: +1-905-201-2455

e-mail: sales.multilin@ge.com

Europe, Middle East, Africa

Tel: +34-94-485-88-00

Fax: +34-94-485-88-45

e-mail: gemultilin.euro@ge.com