

T-Tron® Very Fast-Acting Fuses

Class T — 600 Volt, 1 to 800 Amps

CROSS REF
FOR
30100-280-01

JJS



Catalog Symbol: JJS
Current-Limiting
Very Fast-Acting
Ampere Rating: 1 to 800A
Voltage Rating: 600Vac (or less)
Interrupting Rating: 200,000A RMS Sym.
Agency Information:

UL Listed, Std. 248-15, Class T, Guide JDDZ, File E4273
 CSA Certified, C22.2 No. 248.15, Class 1422-02, File 53787

Catalog Numbers

JJS-1	JJS-45	JJS-200
JJS-2	JJS-50	JJS-225
JJS-3	JJS-60	JJS-250
JJS-6	JJS-70	JJS-300
JJS-10	JJS-80	JJS-350
JJS-15	JJS-90	JJS-400
JJS-20	JJS-100	JJS-450
JJS-25	JJS-110	JJS-500
JJS-30	JJS-125	JJS-600
JJS-35	JJS-150	JJS-800
JJS-40	JJS-175	—

See page 2 of 2 for printed circuit board variations.

Carton Quantity and Weight

Catalog Number	Carton Qty.	Weight*	
		Lbs.	Kg.
1-30	10	0.33	0.149
35-60	10	0.82	0.371
70-100	5	0.51	0.231
110-200	1	0.192	0.087
225-400	1	0.46	0.208
450-600	1	0.85	0.385
800	1	1.65	0.748

*Weight per carton.

Dimensional Data

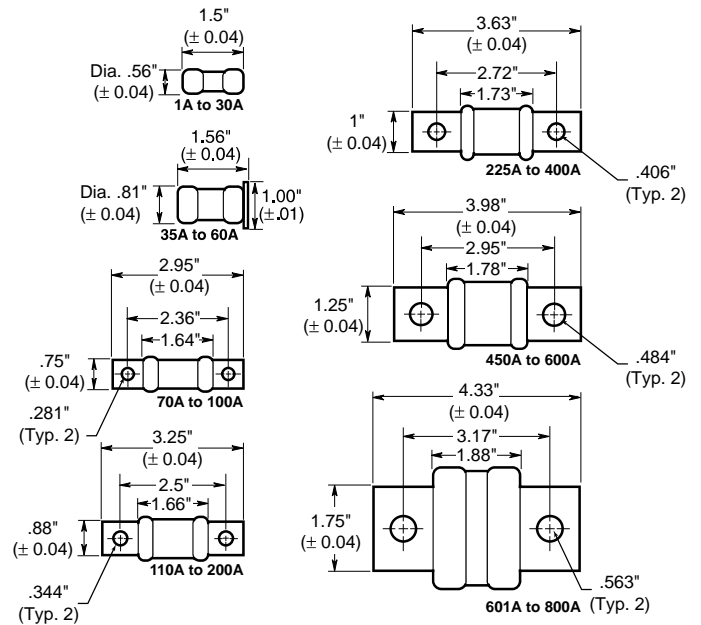

- Small, space-saving fuses provide a high degree of current-limitation on short-circuits for excellent component protection.
- Commonly applied in electric heat circuits, load center, disconnect switches, and meters.
- The small size of the T-Tron fuses permits installation in panelboards and control centers for system upgrading when existing circuit breakers cannot safely interrupt larger available short-circuit currents.
- High speed of response for semiconductor protection.
- Available for printed circuit board applications.



Recommended fuseblocks for
Class T 600V fuses
See Data Sheet: 1116

CE CE logo denotes compliance with European Union Low Voltage Directive (50-1000Vac, 75-1500Vdc). Refer to Data Sheet: 8002 or contact Bussmann Application Engineering at 636-527-1270 for more information.