

MIDGET & CLASS CC

600 VOLT / FUSE BLOCKS



600 VOLT MIDGET AND CLASS CC FUSE BLOCKS

Ferraz Shawmut Midget Fuse Blocks accommodate all 30 ampere 1-1/2" x 13/32" midget fuses. Class CC Fuse Blocks accommodate all 30 ampere Class CC fuses. A choice of box, screw, or pressure-plate connectors fit a wide range of stranded or solid copper wire. Insulators are glass-filled polycarbonate (GFPC) with verified dielectric strength in excess of 2500V. Fuse blocks feature a unique adder block which can be snapped onto 1-, 2- or 3-pole blocks to form multi-pole segmented blocks of as many poles as desired. All fuse clips are made of high conductivity tin-plated copper alloy.

Ratings

- 600VAC: 30A
- Withstand rating: 200kA using screw, pressure plate or box connections, 10kA using quick connects
- Temperature/flammability: GFPC insulators rated 125°C, 94V-0 flammability

Approvals

- All fuse blocks meet the requirements of UL Std. 512
- **Midget Block**
UL Recognized Component
Guide IZLT2, File E52283
- CSA Certified
Class 6225, File 32169
- **Class CC Block**
UL Listed,
Guide IZLT, File E52283
- CSA Certified
Class 6225, File 32169



RECOMMENDED FUSE USAGE

Midget Fuse Blockuse with **ATQ, ATM, A6Y-2B, A25Z-2, TRM, OTM, A13X-2, GFN, GGU, A60Q-2**

Class CC Fuse Blockuse with **ATDR, ATMR, ATQR**

Clip & Connector Types

30A MIDGET/CC

COPPER BOX CONNECTOR



SCREW WITH DOUBLE QUICK-CONNECTS



PRESSURE PLATE WITH DOUBLE QUICK-CONNECTS



PRESSURE PLATE WITH DOUBLE QUICK-CONNECTS (CLASS CC REJECTION END)



MIDGET & CLASS CC

600 VOLT / FUSE BLOCKS

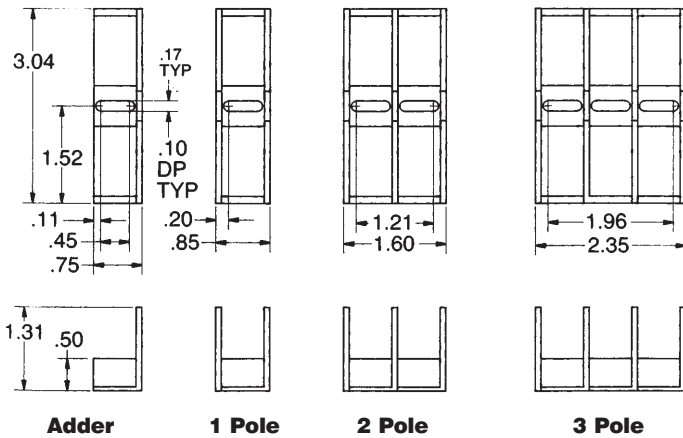

Recommended mounting screws for all Midget and Class CC fuse blocks: #8 (.164" dia.)

600 Volt, 30A Midget and Class CC Fuse Blocks

CONNECTOR		POLES*	CATALOG NUMBER				CONNECTOR TORQUE In - lb
TYPE	WIRE RANGE		TYPE OF FUSE				
			MIDGET	LISTING	CLASS CC	LISTING	
Screw w/double quick connects at both ends	Cu #10-14	ADDER	30310		30310R	UL & CSA	20
		1	30311		30311R		
		2	30312		30312R		
		3	30313		30313R		
		4	30314		30314R		
Pressure plate (sems) w/double quick connects at both ends	Cu #10-14	ADDER	30320		30320R	UL & CSA	20
		1	30321		30321R		
		2	30322		30322R		
		3	30323		30323R		
		4	30324		30324R		
Copper box	Cu #6-14	ADDER	30350		30350R	UL & CSA	35
		1	30351		30351R		
		2	30352		30352R		
		3	30353		30353R		
		4	30354		30354R		

Actual part number to order for spare is 30322AB.

Note: To convert Midget or Class CC adder pole to single pole, use end barrier #U09301.

* Available in any number of poles. Replace last digit in Catalog Number with number of poles needed.

Example: 303112 is a 12-pole screw/double QC connector Midget Fuse Block.

Total width of N poles = (N x .76") + .08 inches. 12 poles = (12 x .76") + .08" = 9.20".

Note: Please see fuse block accessories (H 41) for information regarding fuse block accessories; DFC3M, DFC3LP or DRM.