

VOLTAGE 480AC 60HZ 3Ø
 USE TEMP. 70°C MAX.

INK STAMP

VERSATEX INDUSTRIES
 BRIGHTON MICHIGAN
 STOCK NO.
 480AC 60HZ 3Ø
 CONTAINS MAXIMUM OF _____ LBS.
 NO PCB'S

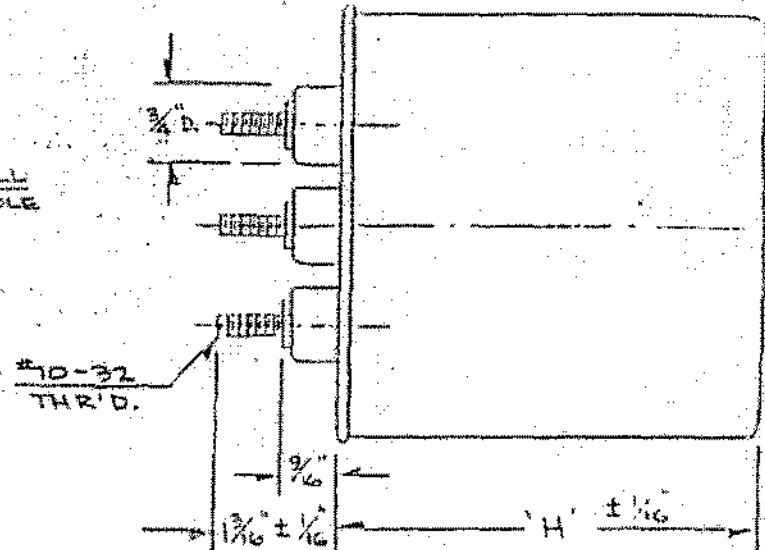
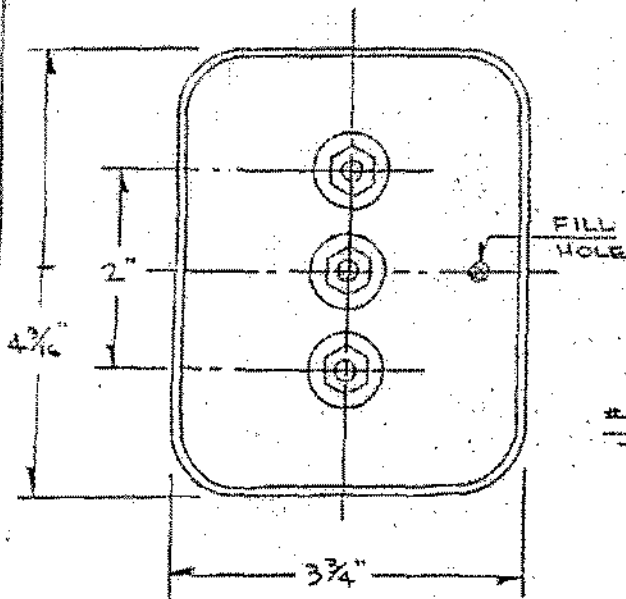

- 1 - NON-INDUCTIVE, FILM / WETMET, NON-PCB DESIGN.
- 2 - CAPACITOR CONTAINS AN INTERNAL PRESSURE SENSITIVE INTERRUPTER.
- 3 - FINISH - TERNEPLATED STEEL
- 5 - MAX. TORQUE 15 IN-LBS.

VERSATEX P/N	KVAR	MF	'H'
43M231	2	24.8	3 7/8"
43M288	2.5	30.9	3 7/8"
43M345	3	37.1	3 7/8"
43M460	4	49.5	4 1/8"
43M575	5	61.9	4 1/4"
43M690	6	74.3	5 1/8"
43M805	7.5	92.8	5 1/4"
43M1150	10	123.8	6 1/4"
43M1438	12.5	154.7	6 1/4"
43M1550	15		8"
43M1650	16.6		8"



CAPACITOR ASSEMBLY
 VERSATEX

DRN. KLQ	CHK.	APPR.	DATE 8-11-87
PART NO.			ISSUE 1

ORDERING GUIDE

PRODUCT NUMBERS for Versa Center and Versa Center Pak, or Versa Tray and Versa Tray Pak, are developed by showing:

STYLE / SERIES / KVAR / FEATURES

STYLE Code

Versa Center

	Allen-Bradley	ABVC
	Cutler-Hammer	CHVC
	Furnas Electric	FNVC
	General Electric	GEVC
	Joslyn Clark	JCVC
	Klockner-Moeller	KMVC
	Siemens	SMVC
	Square D	SDVC
	Westinghouse	WEVC

Versa Center Pak **VCP

** Select the appropriate two letter company code from the Versa Center listings above.

Versa Tray VT

Versa Tray Pak VTP

SERIES Code

	480 VAC, 3-phase, 60 Hz	43M
	240 VAC, 3-phase, 60 Hz	23M

For 600 VAC, and other voltages and frequencies, contact Versatex.

KVAR Code

Versa Center and Versa Tray KVAR rating of the assembly

Versa Center Pak and Versa Tray Pak Group by KVAR rating

Group assemblies by their common KVAR rating. Show how many assemblies have the same KVAR rating. Insert a dash—and then show the group's common KVAR rating.

KVAR Ratings				
SERIES 43M (480VAC, 3-Phase, 60Hz)				
KVAR	KVAR	KVAR	KVAR	KVAR
2	7 1/2	13	18	35
2 1/2	8	13 1/2	20	37 1/2
3	9	14 	22 1/2	40
4	10	15	25	42 1/2
5	11	16	27	45
6	12	17	30	47 1/2
7	12 1/2	17 1/2	32 1/2	50

KVAR Ratings				
SERIES 23M (240VAC, 3-Phase, 60Hz)				
KVAR	KVAR	KVAR	KVAR	KVAR
2	6	11	15	22
2 1/2	7	12	16	25
3	8	12 1/2	17 1/2	
4	9	13	18	
5	10	14	20	

FEATURES

If required, three-phase current limiting protective fusing, using rejection type fuses, can be provided as an option on Versa Center and Versa Tray assemblies—in addition to PAD protection.

Blown fuse indicating lights are also available. They are furnished loose and have two (2) foot wire leads.

	Fusing (Optional)	Code
	Three-phase fusing	RF3
	Fusing and Lights (Optional)	Code
	Three-phase fusing with "Check Fuse" Indicating Lights	ARF3

BUILDING A PRODUCT NUMBER

Versa Center Pak

A unit is required for an Allen-Bradley Motor Control Center (ABVCP). The MCC handles three motors in a 480 VAC, 3-phase, 60 Hz (43M) system. Two motors require 5 KVAR (2-5), one requires 10 KVAR (1-10). Three-phase fusing, using rejection type fuses, plus lights (ARF3) is also a requirement.

Arranging this data in proper sequence, results in a Product Number that reads:

ABVCP/43M/ 2-5, 1-10 /ARF3

PRICING INFORMATION

Contact your Versatex Sales Representative, or the Customer Service Department at the factory.

INSTALLATION NOTE : Versatex capacitor

assemblies are designed to be installed on the load side of the motor starter protective device. If installed on the line side of the motor starter, the assembly must be connected to a fusible disconnect or circuit breaker.

PHYSICAL CHARACTERISTICS

Versa Center Tray Capacity and KVAR Range Data

Shown in the table below are the KVAR values and number of capacitor cells available by Tray Type. The number of cells per tray may decrease as the number of optional features required increase.

VERSAs CENTER Tray Capacity and KVAR Range			
SERIES 43M and SERIES 23M			
Tray Type	Max. Cells per Tray*	KVAR Range per Tray	
		43M Series	23M Series
Allen-Bradley	3	2 - 50	2 - 25
Cutler-Hammer	3	2 - 50	2 - 25
Furnas Electric	3	2 - 50	2 - 25
General Electric	3	2 - 50	2 - 25
Joslyn Clark	3	2 - 50	2 - 25
Klockner-Moeller	3	2 - 50	2 - 25
Siemens	3	2 - 32 1/2	2 - 17 1/2
Square D	3	2 - 50	2 - 25
Westinghouse	3	2 - 50	2 - 25

*Cells per tray may decrease as number of optional features required increases

For KVAR values larger than those shown in the table above, two (2) or more trays are required.

For data on maximum KVAR values for single tray Versa Center Pak assemblies and/or information on Versa Tray Pak units, contact Versatex Industries

DELIVERY: With the Versatex QuickShip 10 program, Versa Center and Versa Tray orders ship within 10 working days from order date.

TERMS OF SALE: Net due within 30 days with approved credit, FOB, Brighton, MI.

Versa Tray Dimensional and Weight Data

To determine VERSAs TRAY dimensions and weights, find the KVAR range for the unit in the table below and then trace across to the desired column(s).

VERSAs TRAY Dimensional and Weight Data			
SERIES 43M			
KVAR Range	No. of Cells	Length Dim. A (in.)	Shipping Weight (lbs.)
2 - 17	1	10	8 - 13
17 1/2 - 32 1/2	2	10	15 - 19
35 - 50	3	14	25 - 28

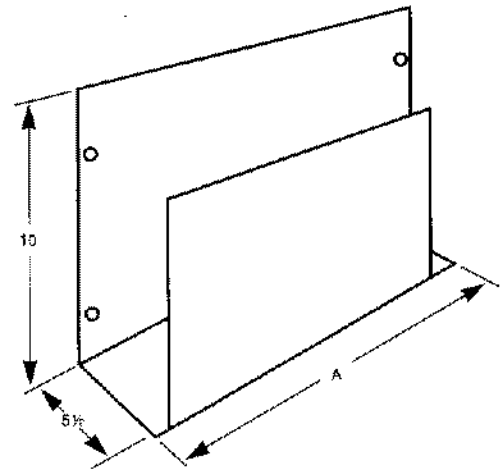

VERSAs TRAY Dimensional and Weight Data			
SERIES 23M			
KVAR Range	No. of Cells	Length Dim. A (in.)	Shipping Weight (lbs.)
2 - 9	1	10	8 - 13
10 - 17	2	10	13 - 16
17 1/2 - 25	3	14	18 - 20

Versatex reserves the right to select the combination of cells for each tray assembly and the size of the trays that make up each assembly.