

Advanced power quality analysis coupled with revenue accuracy in a web compatible meter

PowerLogic® ION7550/ION7650 series

Energy and power meters

CROSS TO ROCKWELL PN-156556
VENDOR P/N S7550A0C0B6A0C



Industry



by Schneider Electric



Installation

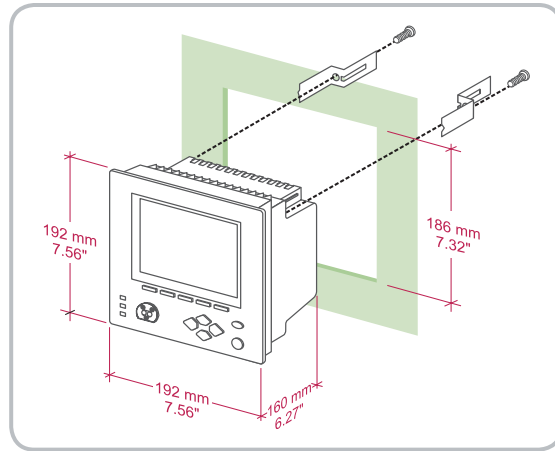

Designed to fit DIN standard 192 cutout (186 mm by 186 mm). Circuit and control power connections include 4-Wire Wye, 3-Wire Wye, 3-Wire Delta, Direct Delta and single-phase systems. four voltage and five current inputs.

Front panel

Use for both display and configuration purposes. The large backlit LCD display screen and the numerous selection, navigation and configuration softkeys allow quick, secure access to basic meter configuration screens. The front panel also provides access to many other meter functions, such as meter resets and has multiple programmable screens for numeric and time-stamped values, frequency spectrum (harmonics), trend logs and name plate data.

The large display automatically scrolls through displays screens that present at-a-glance Volts, Amps, power, energy and demand values. Screens are easily customized to suit user requirements. Set parameter measurements via front panel to comply with regional preferences. Modbus Master feature allows display of real-time parameters of any downstream modbus devices.

Input(s)	Specifications
Voltage inputs	
Nominal full scale	347 Vac direct line-to-neutral, 600 Vac direct line-to-line, RMS
Overload	1500 Vac RMS continuous
Input impedance	5 M Ω /phase (phase-Vref)
Fault capture	1200 V peak
Current inputs	
Nominal current	5 A, 10 A and/or 20 A (1 A, 2 A, 5 A optional current range)
Max. voltage	600 V RMS (CAT III IEC 61010-1)
Withstand	2500 Vac, 60 Hz for 1 min
Load/burden	0.05 VA/phase (at 5 A standard) 0.015 VA/phase (at 1 A optional)
Impedance	0.002 Ω /phase (phase-Vref) 0.015 Ω (optional current range)
Control power	
Operating range	Standard: AC: 85 Vac to 240 Vac ($\pm 10\%$), 47 Hz to 63 Hz; DC: 110 Vdc to 300 Vdc ($\pm 10\%$) Burden: Typical 15 VA, max. 35 VA Optional: low voltage DC power supply Rated inputs: DC: 20 Vdc to 60 Vdc ($\pm 10\%$) Burden: Typical 12 VA, max. 18 VA
Current probes with AC voltage output	
Rated inputs	1 V RMS
Overload	5.5 V (CAT I IEC 61010-1)
Impedance	220 k Ω max.
Options	Current probe inputs for use with 0 Vac to 1 Vac current probes. Probes sold separately. Accuracy depends on probe specs. Current probe inputs with three calibrated Universal Technic 10 A clamp-on CTs, meeting IEC 61036 accuracy.

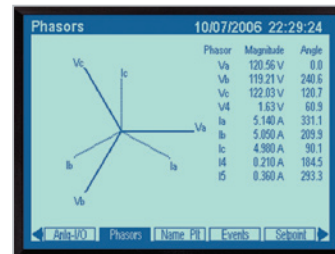

Phasors display

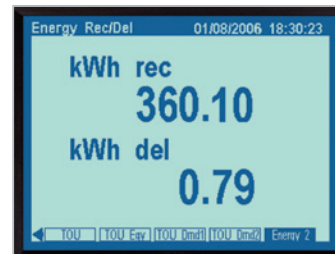

Energy received/delivered display

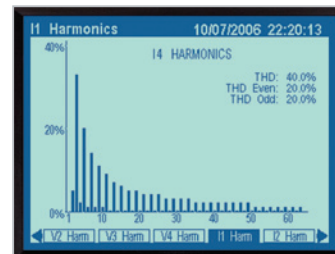

Harmonic current display

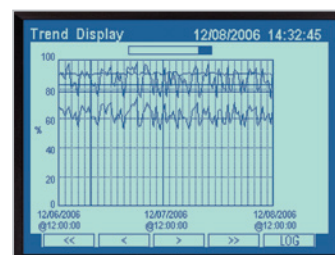

Trend display

Power and energy measurements

High-accuracy four-quadrant energy metering in accordance with IEC 62053-22 Class 0,2S for both 3- and 2-element systems. Real, bidirectional, reactive and apparent values. Fully programmable integrating period (1, 5, 10, 15, 30, 60 min or other).

Supports block, rolling block and predicted demand calculations such as: kW, kVAr and kVA demand, min./max.; Volts and Amps demand, min./max.; cumulative demand; demand on any instantaneous measurement.

Measurement specifications ^[1]	
Parameter	Accuracy ± (% reading)
Voltage (line-line, line-neutral): per phase, min./max., unbalance	0.1%
Frequency: present, min./max.	±0.005 Hz
Current (I1, I2, I3)	0.1%
Current (I4, I5)	0.4%
Power: real (kW), reactive (kVAr), apparent (kVA), per-phase, total	IEC 62053-22 Class 0,2S ^[2]
Energy: real (kWh), reactive (kVAh), apparent (kVAh), in/out	IEC 62053-22 Class 0,2S ^[2]
kWA, kVA demand calculations	IEC 62053-22 Class 0,2S ^[2]
Power factor (at Unity PF)	0.2%

^[1] Refer to user's manual for valid measurement ranges

^[2] Refer to compliance section. Not applicable for NICT meters, contact factory for measurement specifications

Power quality

Power quality compliance monitoring for international quality-of-supply standards plus specific data for localized and custom compliance agreements and network connection requirements.

- **Harmonics (all models):** individual harmonics up to the 63rd, K factor and total harmonics distortion (THD).
- **Sag/swell (all models):** voltage waveforms for sags and swells (i.e. ITI (CBEMA)) Type 2 and Type 3 disturbances); report on each disturbance's magnitude and duration. Detect sub-disturbances during a sag/swell event.
- **Disturbance direction detection (all models):** analyze disturbance information to determine the direction of the disturbance relative to the meter. Results are provided in the event log, along with time-stamp and the level of certainty of disturbance direction.
- **EN50160 (ION7650 with EN50160 ordering option only):** monitor compliance with EN50160 parameters.
- **IEC 61000-4-30 (ION7650 only):** monitor compliance of relevant 4-30 parameters such as power frequency, magnitude of supply voltage, flicker, supply voltage sags/swells, transients and voltage interruptions.
- **Transient (ION7650 only):** voltage waveforms of transient activity (i.e., ITI CBEMA Type 1 disturbances).
- **COMTRADE waveform format:** records are available directly from the meter via the FTP server (meters with Ethernet port option only)

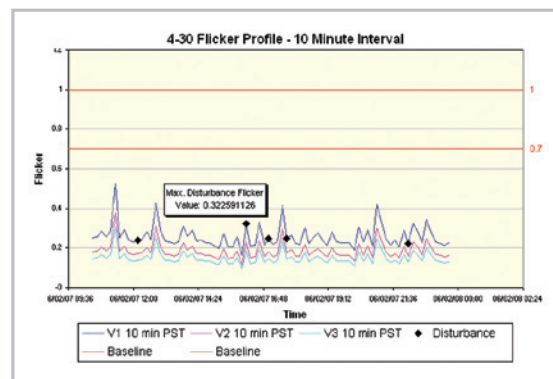

Example screen from PowerLogic ION Enterprise software showing continuous, wide-area monitoring, data capture and reporting for power quality and reliability conditions.



Data and event logging

Ships with a comprehensive data-logging configuration. Data is prioritized and stored on-board in nonvolatile memory to eliminate data gaps in the event of outages or server downtime. Retrieved data is stored in an ODBC-compliant database when using ION Enterprise. Trending and forecasting capabilities track specified quantities over time and forecast the value of future quantities. View trending and forecasting data through the meter's web pages. Logging capacity is available in 5 MB or 10 MB configurations. Default depth and interval of logging is set at the factory, and depends upon on-board memory size.

- Revenue log: configured for use with UTS MV-90 billing software. Logs kWh del. int., kWh rec. int., kVARh del. int., kVARh rec. int. values.
- Historic logs: record standard power system quantities, such as phase current, phase voltage and power factor.
- Report generator log: configured to provide power system data for ION Enterprise software.
- Event log
- Trend display logs

> Multiple tariffs and time-of-use (TOU) calculations

20-year calendar with automatic leap-year and seasonal time adjustments and clock synchronization over communications channel or GPS. TOU is configured four seasons, five daily profiles per season, four tariff periods per daily profile. Automatic mid-season rate change. Active, reactive and apparent energy and demand; automatic recording of max. (peak) demand during each tariff period.

> Example logging configurations:

	ION7550		ION7650	
Event	500 events	500 events	500 events	500 events
Data ^[1]	1.5 yrs	3.1 yrs	1.3 yrs	2.9 yrs
Waveforms	180 ^[2]	180 ^[2]	360 ^[3]	360 ^[3]

^[1] 16 parameters recorded every 15 min

^[2] 30 waveforms on 6 channels at the max. sampling rate

^[3] 30 waveforms on 12 channels with any selectable format (for example, 6 channels are 512 samples/cycle for 4 cycles and 6 channels are 32 samples/cycle for 54 cycles)

Inputs and outputs

All models provide digital inputs as well as Form C (mechanical relays) and Form A (solid state relays) digital outputs. Optional digital and analog I/O is also available.

Digital output relays respond to internal alarms, external digital input status changes or commands over communications. Use digital inputs to trigger alarms or logging, synchronize to a demand pulse or control conditional energy accumulation.

Type	Input/output	Specifications
Electro-mechanical relays	3 Form C relays: R1-R3 Form C contacts: NO, K, NC	250 Vac/30 Vdc, max. voltage: 380 Vac/125 Vdc. Turn-on time: 15 ms max.; Turn-off time: 5 ms max. Update rate: ½-cycle or 1 sec
Solid state relays	4 Form A digital outputs: D1-D41	Max. voltage: 30 Vdc; max. current: 80 mA; isolation: optical; update rate: ½-cycle or 1 sec
Analog (option)	4 inputs: AI 1 to AI 4	Signal type: DC current; range: 0 to 20 mA (scalable 4 to 20), or 0 to 1 mA; accuracy: ±0.3% of full scale; update rate: 1 sec
	4 outputs: AO1 to AO4	Signal type: DC current; range: 0-20 mA (scalable 4-20) or -1 mA to 1 mA (scalable 0-1); update rate: ½-cycle or 1 sec
Digital	8 inputs: S1-S8	SCOM self-excited, dry contact sensing, no external voltage required. Min. pulse width: 1 ms; max. pulse rate: 20 pulses/sec. Timing resolution: 1 ms; update rate: ½-cycle (after timing resolution); isolation: 300 V peak; max. rated voltage 120 Vdc (external excitation)
	8 inputs (option): DI1-DI8	Self-excited (internal 30 Vdc supply); dry contact sensing, or with external excitation 1.3 mm ² to 0.1 mm ² (16 AWG to 28 AWG); min. pulse width: 20 ms; max. pulse rate: 25 pulses/sec; updated ½-cycle (after timing resolution)

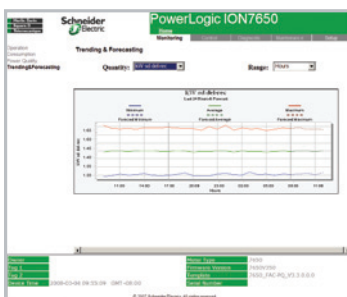

Trending and forecasting, as viewed from PowerLogic ION7650 web page

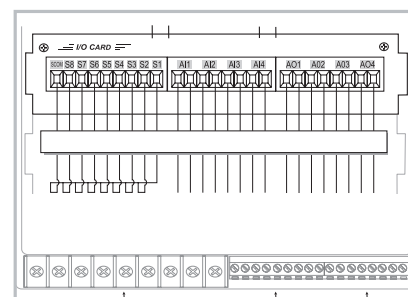

PowerLogic ION7650 I/O card

Communications

EtherGate and ModemGate

The meters can provide gateway functionality depending on communication options.

EtherGate: provides access via Modbus TCP through the meter's Ethernet port to devices communicating via Modbus connected to the meter's serial ports.

ModemGate: provides access from the telephone network to devices connected to the meter's serial ports.

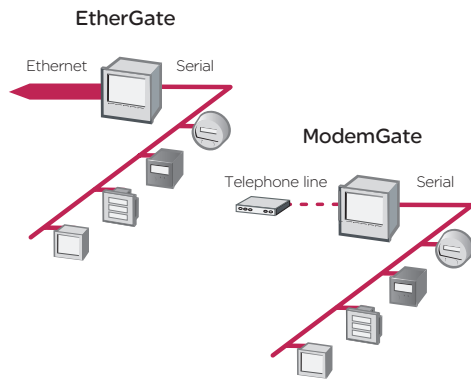

Internet connectivity

Exchange information using XML to integrate with custom reporting, spreadsheet, database, and other applications.

WebMeter®: an on-board web server, provides access to real-time values and PQ data through any web-enabled device and even supports basic meter configuration tasks.

MeterM@il®: automatically emails user-configured, high-priority alarm notifications or scheduled system-status update messages to anyone, anywhere within the facility or around the world.

Multiple communication ports that operate simultaneously allow the meters to be used as part of a power and energy management system and to interface with other automation systems. Upload waveforms, alarms, billing data and more to software for viewing and analysis.

Port	Specifications
Serial RS-232/RS-485 port (COM 1)	Protocols include ION, Modbus RTU, Modbus Master, DNP 3.0, GPS, EtherGate, ModemGate. Data rates: 300 bps to 115,200 bps (RS-485 limited to 57,600 bps). Connectors: male DB9 (RS-232 DTE) or captured wire (RS-485). Duplex: Full (RS-232), Half (RS-485)
Serial RS-485 port (COM 2)	Protocols include ION, Modbus RTU, Modbus Master, DNP 3.0, GPS, EtherGate, ModemGate. Data rates: 300 bps to 57,600 bps 2400 to 38400. Duplex: Half
Internal modem (COM 3)	Data rates: 300 bps to 33.6 kbps (V.3.4, V.32 bis, V.32, V.22 bis, V.22 A/B, V.23, V.21, Bell 212A, Bell 103). Supports automatic data rate detection. RJ11 interface. Approvals: FCC P68 (USA), Industry Canada CS-03. Also approved for use in: Austria, Belgium, Denmark, Finland, France, Germany, Greece, Iceland, Ireland, Italy, Luxembourg, Netherlands, Norway, Portugal, Spain, Sweden, Switzerland, United Kingdom
ANSI Type 2 optical port (COM 4)	Protocols include ION, DNP 3.0, Modbus RTU Data rates: 1200 bps to 19,200 bps. Half duplex
Ethernet port	Protocols: TCP/IP, Telnet, ION, Modbus TCP, SNMP Interface: IEEE 802.3-1993, ISO/IEC 8802-3:1993, IEC 61850 (Ethernet). Data rates: 10 Mbps, Half duplex 10BASE-T, 100BASE-TX: Connectors: RJ45, cabling: unshielded twisted-pair cable, 0.5 mm (24 AWG), max. length 100 m (109 yds). Isolation: Transformer isolated to 1500 V RMS 100BASE-FX (fibre) connectors: ST; Cabling: Fibre optic cable, 62.5/125 µm nominal, wavelength 820 nm, max. length 2000 m

General specifications

Description	Specifications
Accuracy	IEC 62053-22 0,2S, 1 A and 5 A tested by KEMA; Complies with ANSI C12.20, Class 10 and Class 20
Safety/construction	IEC 1010-1 (EN61010-1); CSA C22.2 No 1010-1; UL 61010B-1 Electromagnetic Immunity; IEEE C.37-90.1-1989; EN50082-2
Electromagnetic compatibility	IEC 61000-4-2 (EN61000-4-2/IEC 8012); IEC 61000-4-3 (EN61000-4-3/IEC 801-3) Radiated EM Field Immunity IEC 61000-4-4 (EN61000-4-4/IEC 801-4) Electric Fast Transient; IEC 61000-4-5 (EN61000-4-5/IEC 801-5) Surge Immunity IEC 61000-4-6 (EN61000-4-6/IEC 801-6) Conducted Immunity; IEC 61000-3-2 (EN61000-3-2); IEC 61000-3-3 (EN61000-3-3) FCC Part 15 Subpart B, Class A Digital Device; EN55011 (CISPR 11); EN55022 (CISPR 22); EN61000-6-4 (EN50081-2)
Environmental conditions	Operating temperature: -20° C to +70° C (no formation of ice) (-4° F to 158° F) Low Voltage DC Power Supply: -20° C to 50° C (-4° F to 122° F) Storage: -40° C to +85° C (-40° F to 185° F) Humidity: 5% to 95% non-condensing

Select one code from each ordering category and fill in the boxes below. Use this group of codes when you order your ION7550.

Brand	Model	Form Factor	Current inputs	Voltage inputs	Power supply	System Freq	Comm	I/O	Security	Special Order
■	7550	■	■	0	■	■	■	■	■	■

ION7550	Order Code	Description
Brand	S	Square D branded
	P	Power Measurement branded
	M	Schneider Electric branded
Model	7550	ION7550: Advanced meter with wide-range voltage inputs (57-347 line-neutral or 100-600V line-line), sag/swell detection, data and waveform recording, and 256 samples/cycle resolution. Supports ION, Modbus RTU and DNP 3.0 protocols.
Form Factor	A0	Integrated display with front optical port and 5 MB logging memory
	B0	Integrated display with front optical port and 10 MB logging memory.
	T0	Transducer (no display) version, with 5 MB logging memory.
	U0	Transducer (no display) version, with 10 MB logging memory.
Current	C	5 Amp nominal, 20 Amp full scale current input
	E	1 Amp nominal, 10 Amp full scale current input
	F	Current Probe Inputs (for use with 0-1 VAC current probes; probes sold separately) - NOT AVAILABLE with OFGEM option
	G	Current Probe Inputs with three Universal Technic 10A clamp on CTs; meets IEC 1036 accuracy - NOT AVAILABLE with OFGEM option
Voltage Inputs	0	57 to 347 VAC line-to-neutral / 100 to 600 VAC line-to-line
Power Supply	B	Standard power supply (85-240 VAC, ±10%/47-63 Hz / 110-330 VDC, ±10%)
	C	Low voltage DC power supply (20-60 VDC)
System Frequency	5	Calibrated for 50 Hz systems
	6	Calibrated for 60 Hz systems. NOT AVAILABLE with OFGEM option
Communication	A0	Standard communications (1 RS-232/RS-485 port, 1 RS-485 port). Integrated display models also include 1 ANSI Type 2 optical communications port.
	C1	Standard communications plus 10BASE-T/100BASE-TX Ethernet (RJ-45), 56k universal internal modem (RJ-11). Ethernet and modem gateway functions each use a serial communications port.
	D7	Standard communications plus 10BASE-T/100BASE-TX Ethernet (RJ-45) and 100BASE-FX Ethernet Fiber, 56k universal internal modem (RJ-11). Ethernet and modem gateway functions each use a serial communications port.
	E0	Standard communications plus 10BASE-T/100BASE-TX Ethernet (RJ-45). Ethernet gateway function uses a serial communications port.
	F1	Standard communications plus 10BASE-T/100BASE-TX Ethernet (RJ-45) and 100BASE-FX (SC fiber optic connection). Ethernet gateway function uses a serial communications port.
	M1	Standard communications plus 56k universal internal modem (RJ-11). Modem gateway function uses a serial communications port.
I/O	A	Standard I/O (8 digital inputs, 3 Form C relays, 4 Form A solid-state outputs)
	D	Standard I/O plus Expansion I/O card (8 additional digital inputs & four 0 to 1 mA analog inputs)
	E	Standard I/O plus Expansion I/O card (8 additional digital inputs & four 0 to 20 mA analog inputs)
	H	Standard I/O plus Expansion I/O card (8 additional digital inputs & four -1 to 1 mA analog outputs)
	K	Standard I/O plus Expansion I/O card (8 additional digital inputs & four 0 to 20 mA analog outputs)
	N	Standard I/O plus Expansion I/O card (8 additional digital inputs & four 0 to 20 mA analog inputs and four 0 to 20 mA outputs)
	P	Standard I/O plus Expansion I/O card (8 additional digital inputs & four 0 to 1 analog inputs & four -1 to 1 mA analog outputs)
Security	0	Password protected, no hardware lock
	1	Password protected and hardware lockable (lock enabled/disabled via jumper on comm card)
	3	*RMICAN Measurement Canada approved, security lock enabled
	4	*RMICAN-SEAL Measurement Canada approved, factory sealed, security lock enabled
	6	Password protected with security lock enabled, terminal cover and UK OFGEM labels
Special Order	A	None
	C	Tropicalization treatment applied

P/N S7550A0C0B6A0C

* RMICAN approval for Delta mode sealing is not yet available. Please contact factory for details